

MHI
Copy 3

~~RESTRICTED~~

UNCLASSIFIED FM 30-50

WAR DEPARTMENT

BASIC FIELD MANUAL



MILITARY INTELLIGENCE
IDENTIFICATION OF
UNITED STATES NAVAL VESSELS

October 11, 1941

REGRADED UNCLASSIFIED BY
AUTHORITY OF DOD DIR. 5200.1 R
BY RAKERS ON 102103

~~RESTRICTED~~

FM 30-50

BASIC FIELD MANUAL



MILITARY INTELLIGENCE
IDENTIFICATION OF
UNITED STATES NAVAL VESSELS

Prepared under direction of the
Chief of Staff



UNITED STATES
GOVERNMENT PRINTING OFFICE
WASHINGTON : 1941

WAR DEPARTMENT,
WASHINGTON, October 11, 1941.

FM 30-50, Military Intelligence, Identification of United States Naval Vessels, is published for the information and guidance of all concerned.

[A. G. 062.11 (8-11-41).]

BY ORDER OF THE SECRETARY OF WAR:

G. C. MARSHALL,
Chief of Staff.

OFFICIAL:

E. S. ADAMS,
Major General,
The Adjutant General.

DISTRIBUTION:

R and H 1 (6); I R 4 (5); I Bn 1 (5), 4 (3); I C 4 (10).
(For explanation of symbols see FM 21-6.)

TABLE OF CONTENTS

SECTION I. General.	Paragraph	Page
Purpose-----	1	1
Scope-----	2	1
II. Battleships-----		3
III. Aircraft carriers-----		37
IV. Heavy cruisers-----		55
V. Light cruisers-----		85
VI. Destroyers-----		107
VII. Mine layers-----		149
VIII. Submarines-----		155
IX. Torpedo boats, gun boats, tenders, etc-----		173

BASIC FIELD MANUAL

MILITARY INTELLIGENCE

**IDENTIFICATION OF UNITED STATES NAVAL
VESSELS**

SECTION I

GENERAL

■ 1. **PURPOSE.**—The purpose of this manual is to serve as a guide in the identification of naval vessels of the United States. The material has been secured from many sources. It is the best available but may be incomplete, and in some respects inaccurate.

■ 2. **SCOPE.**—This manual, containing illustrations with explanatory data relative to naval vessels of the United States, is published for limited distribution. When illustrations are not given, blank spaces have been left so that they may be added when provided. The manual will be used for instruction of officers and men in the appearance and general characteristics of naval vessels of the United States, and will be safeguarded as provided in AR 380-5.

SECTION II
BATTLESHIPS

MILITARY INTELLIGENCE

UNITED STATES
NAVY

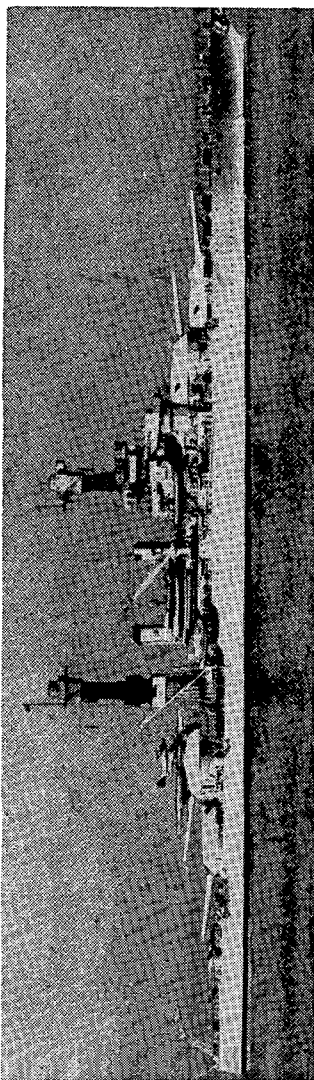

WEST VIRGINIA

IDENTIFICATION OF U. S. NAVAL VESSELS

Battleship
COLORADO CLASS

COLORADO CLASS

COLORADO
MARYLAND
WEST VIRGINIA

Description: Displacement, 33,590 tons full load.
Length, 600 feet (water line).
Beam, 97½ feet.
Maximum draft, 35 feet.
Speed, 21 knots.

Guns: 8 16-inch.
12 5-inch.
8 5-inch AA.
2 1-pounders.
2 machine guns.
11 machine guns AA.

Torpedo tubes: None.

Airplanes: 3. Catapults: 1 on No. 3 turret.

Turrets: 4 2-gun. 1 on quarter-deck.

MILITARY INTELLIGENCE

UNITED STATES
NAVY

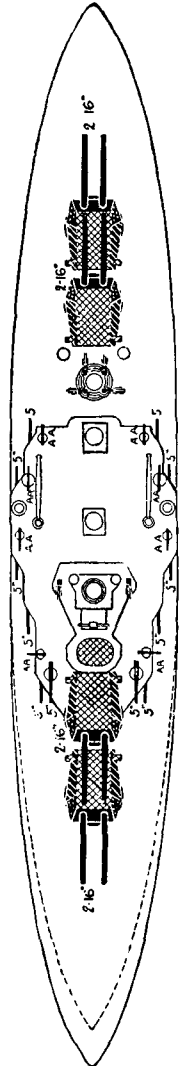
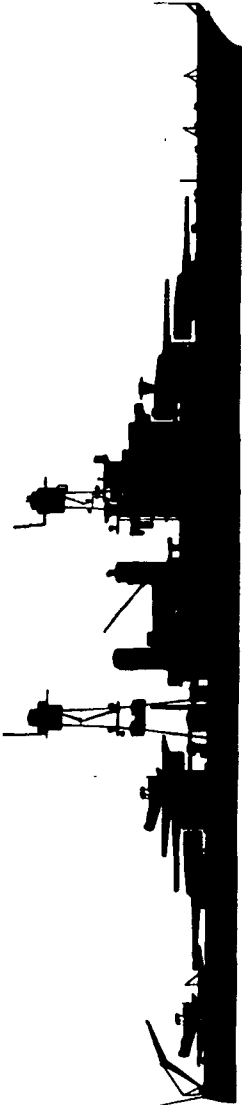

IDENTIFICATION OF U. S. NAVAL VESSELS

Battleship
COLORADO CLASS



COLORADO

MILITARY INTELLIGENCE

UNITED STATES
NAVY

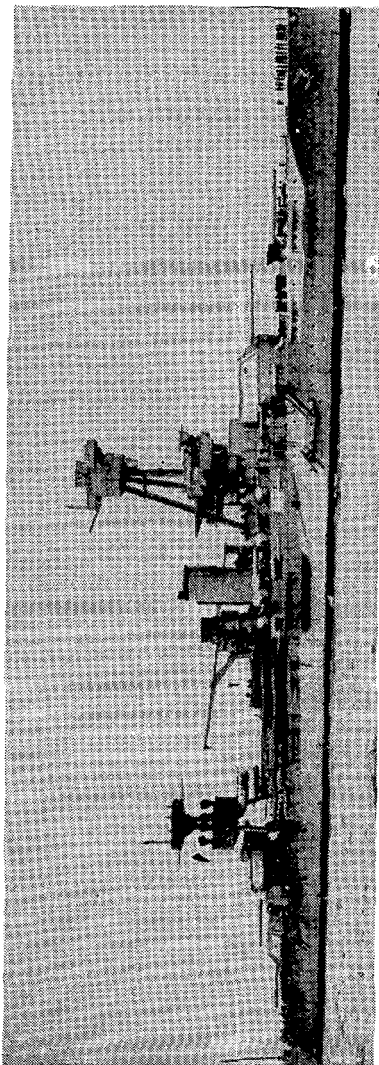

NEW YORK

IDENTIFICATION OF U. S. NAVAL VESSELS

Battleship
TEXAS CLASS

TEXAS CLASS

NEW YORK
TEXAS

Description: Displacement, 30,000 tons full load.
Length, 566 feet (water line).
Beam, 106 feet.
Maximum draft, 31½ feet.
Speed, 21 knots.

Guns: 10 14-inch.
16 5-inch.
8 3-inch AA.
2 1-pounders.
3 machine guns.
2 landing guns.

Torpedo tubes: None.

Airplanes: 3.

Catapults: 1 on No. 3 turret.

Turrets: 5 2-gun.

MILITARY INTELLIGENCE

UNITED STATES
NAVY

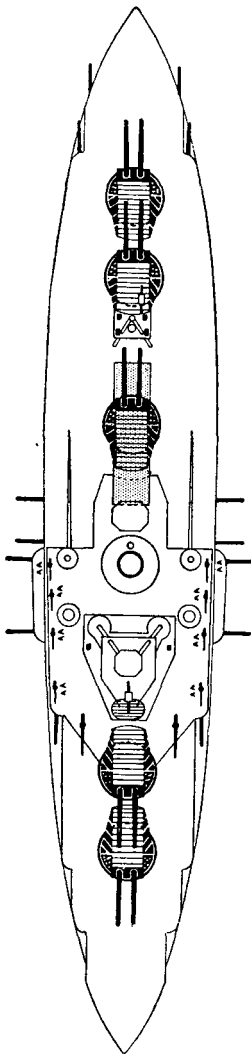
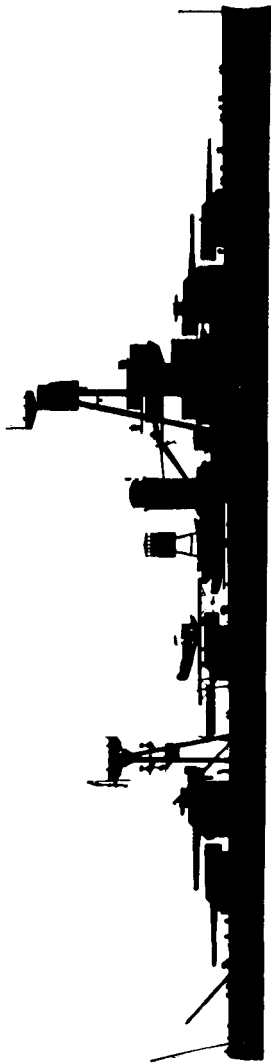

IDENTIFICATION OF U. S. NAVAL VESSELS

Battleship
TEXAS CLASS

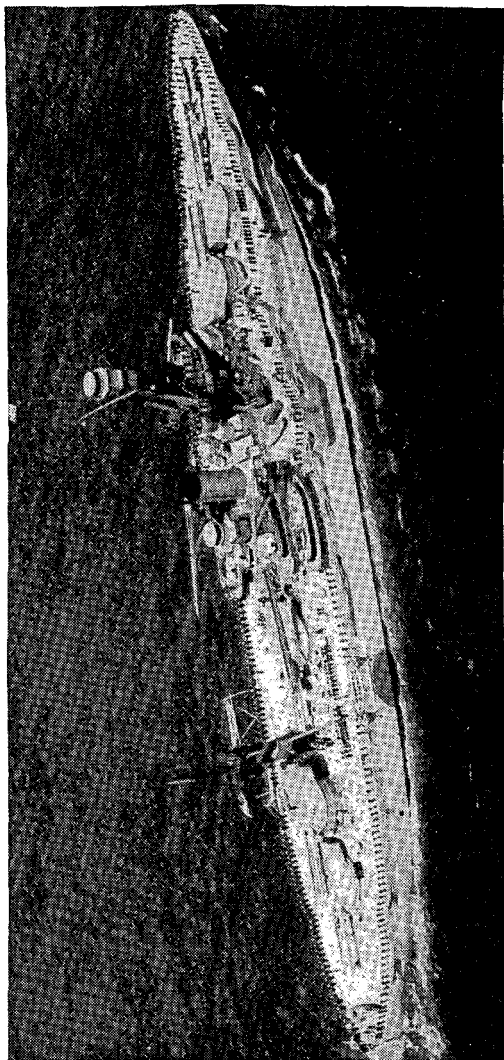

TEXAS

MILITARY INTELLIGENCE

UNITED STATES
NAVY

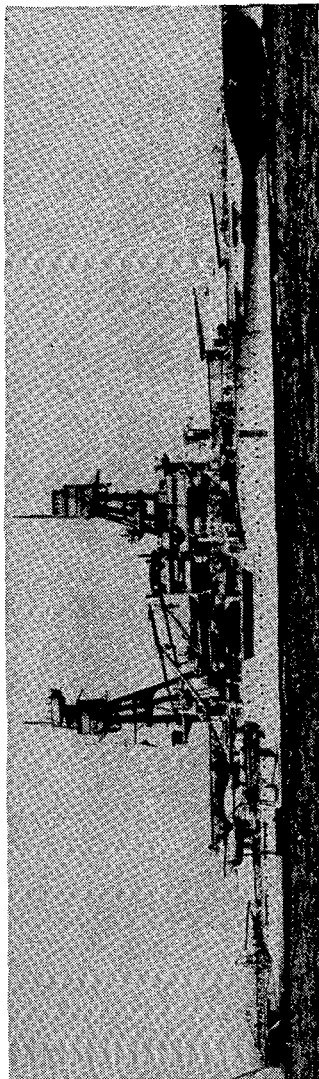

NEVADA

IDENTIFICATION OF U. S. NAVAL VESSELS

Battleship
OKLAHOMA CLASS

OKLAHOMA CLASS

OKLAHOMA
NEVADA

Description: Displacement, 29,000 tons.
Length, 575 feet (water line).
Beam, 107 11/12 feet.
Maximum draft, 32½ feet.
Speed, 20½ knots.

Guns: 10 14-inch.
12 5-inch.
8 5-inch AA.
8 machine guns.

Torpedo tubes: None.

Airplanes: 3. Catapults: 1 on No. 3 turret.
1 on quarter-deck.

Turrets: 2 3-gun.
2 2-gun.

MILITARY INTELLIGENCE

UNITED STATES
NAVY

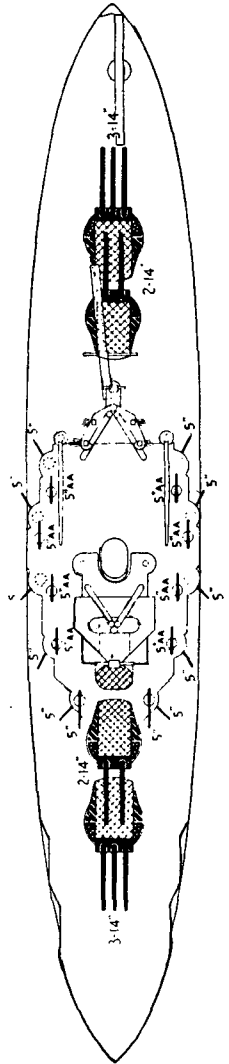
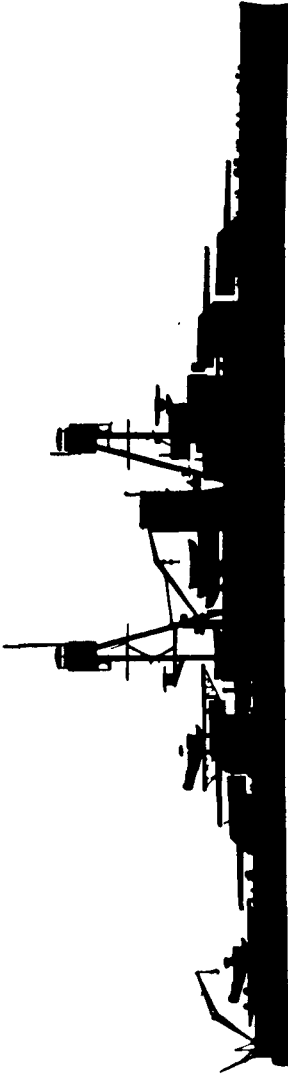

IDENTIFICATION OF U. S. NAVAL VESSELS

Battleship
OKLAHOMA CLASS

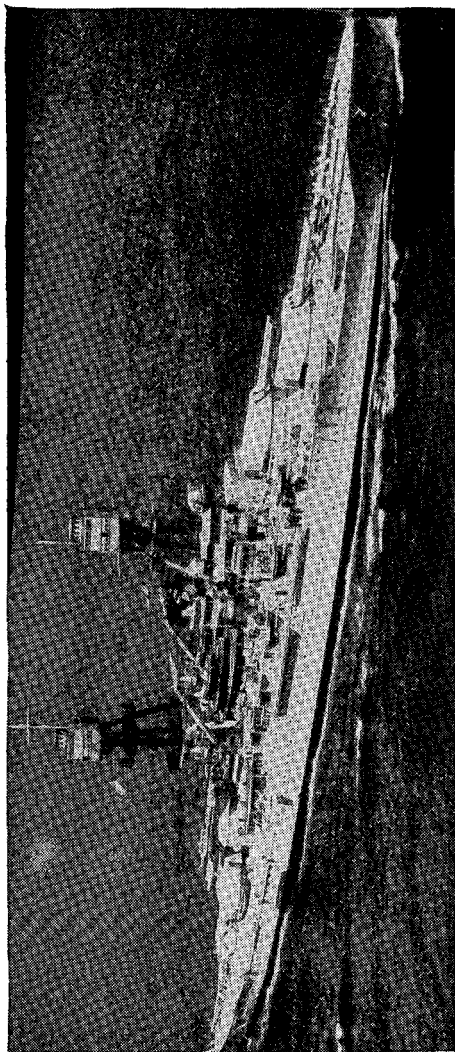

OKLAHOMA

MILITARY INTELLIGENCE

UNITED STATES
NAVY

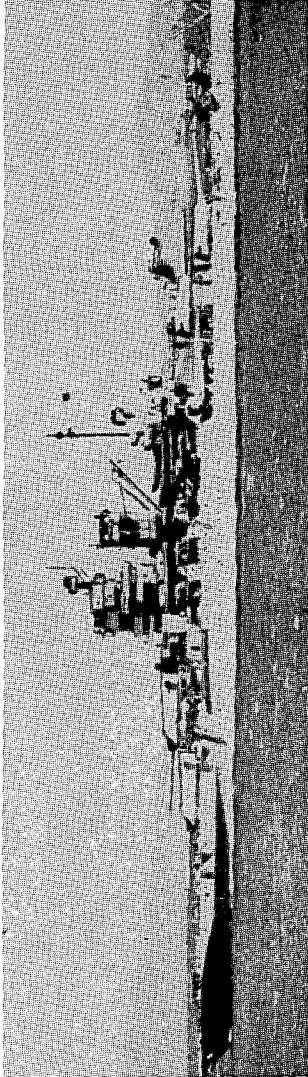

IDAHO

IDENTIFICATION OF U. S. NAVAL VESSELS

Battleship
IDAHO CLASS

IDAHO CLASS

IDAHO
MISSISSIPPI
NEW MEXICO

Description: Displacement, 33,400 tons.
Length, 600 feet (water line).
Beam, 106¼ feet.
Maximum draft, 34 feet.
Speed, 21½ knots.

Guns: 12 14-inch.
12 5-inch.
8 5-inch AA.
12 machine guns AA.

Torpedo tubes: None:

Airplanes: 3. Catapults: 1 on No. 3 turret.
1 on quarter-deck.

Turrets: 4 3-gun.

UNITED STATES
NAVY

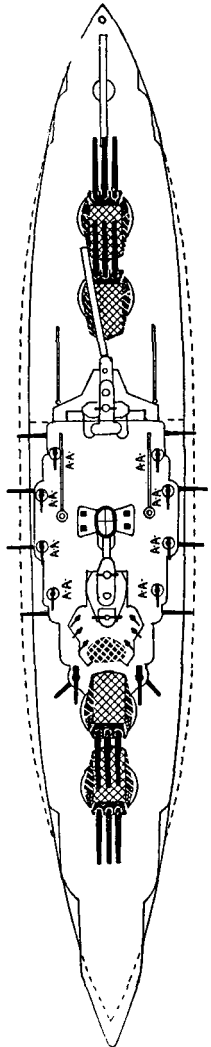
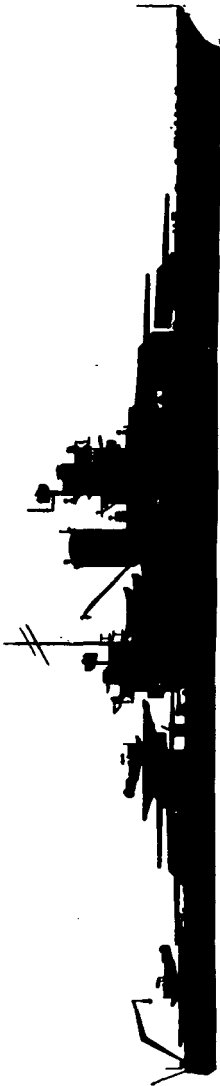

IDENTIFICATION OF U. S. NAVAL VESSELS

Battleship
IDAHO CLASS

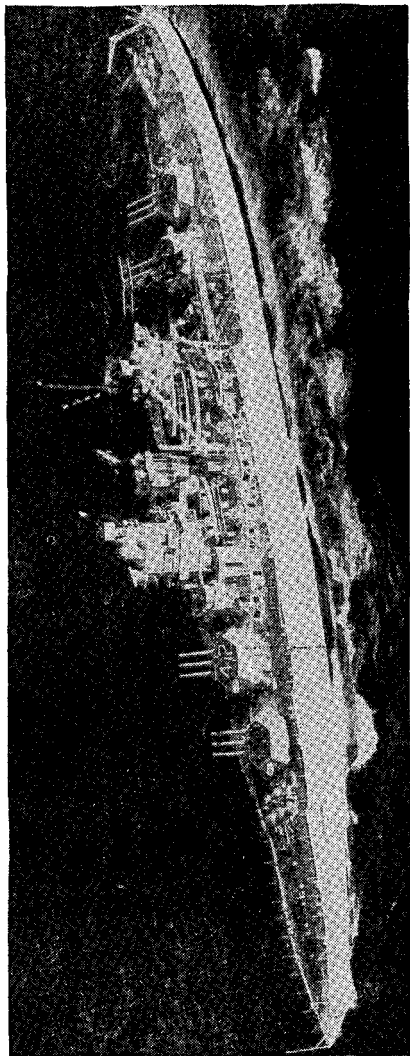

IDAHO

MILITARY INTELLIGENCE

UNITED STATES
NAVY

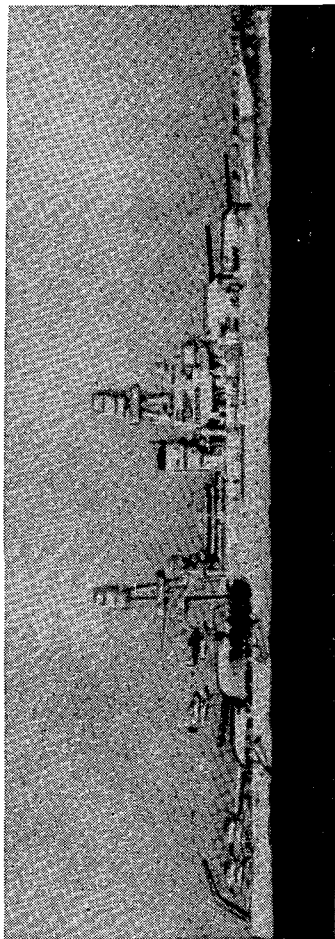

PENNSYLVANIA
(Showing heightened funnel)

IDENTIFICATION OF U. S. NAVAL VESSELS

Battleship
ARIZONA CLASS

ARIZONA CLASS

ARIZONA
PENNSYLVANIA

Description: Displacement, 32,600 tons.
Length, 600 feet (water line).
Beam, 106 $\frac{1}{4}$ feet.
Maximum draft, 33 $\frac{1}{2}$ feet.
Speed, 21 knots.

Guns: 12 14-inch.
12 5-inch.
8 5-inch AA.

Torpedo tubes: None.

Airplanes: 3. Catapults: 1 on No. 3 turret.
1 on quarter-deck.

Turrets: 4 3-gun.

MILITARY INTELLIGENCE

UNITED STATES
NAVY

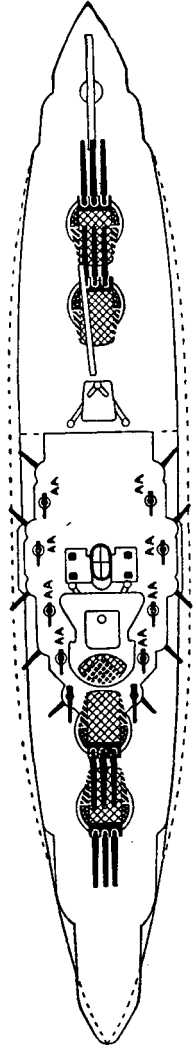
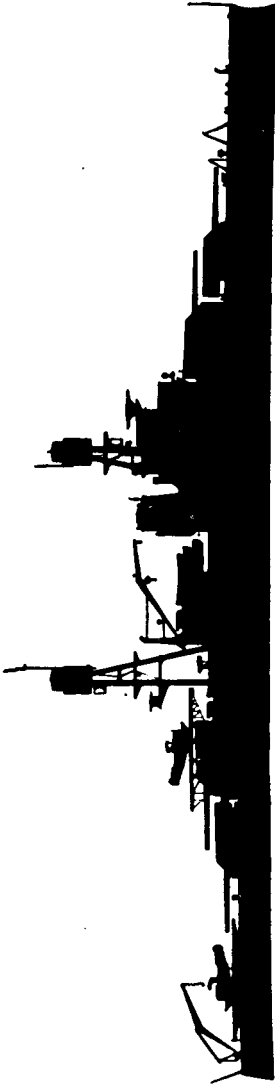

IDENTIFICATION OF U. S. NAVAL VESSELS

Battleship
ARIZONA CLASS

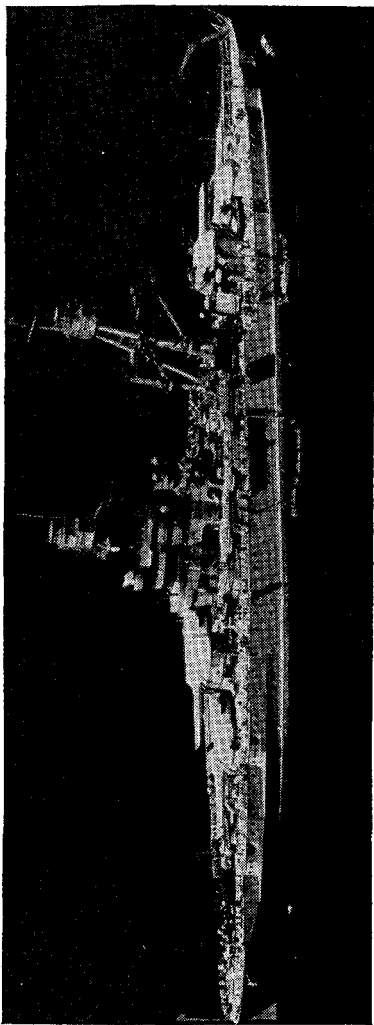

ARIZONA

MILITARY INTELLIGENCE

UNITED STATES
NAVY

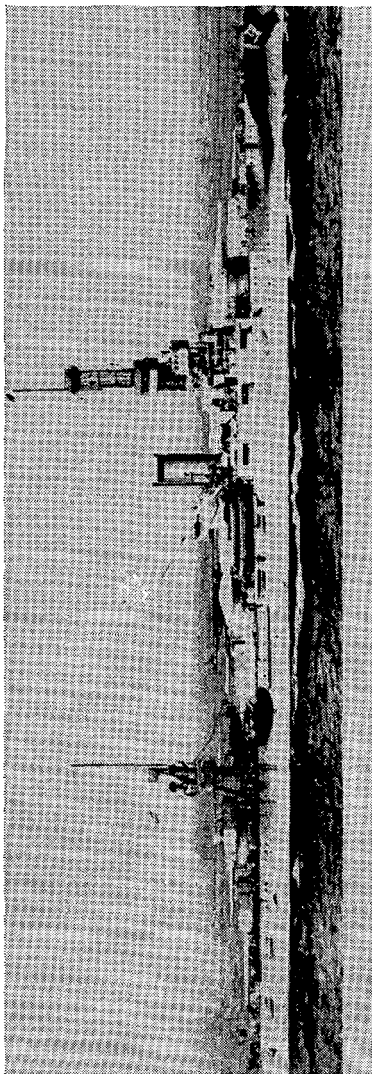

ARKANSAS

IDENTIFICATION OF U. S. NAVAL VESSELS

Battleship
ARKANSAS CLASS

ARKANSAS CLASS

ARKANSAS

Description: Displacement, 29,000 tons full load.
Length, 555½ feet (water line).
Beam, 106 feet.
Maximum draft, 32 feet.
Speed, 20½ knots.

Guns: 12 12-inch.
16 5-inch.
8 3-inch AA.

Torpedo tubes: None.

Airplanes: 3. Catapults: 1 on No. 3 turret.

Turrets: 6 2-gun.

MILITARY INTELLIGENCE

UNITED STATES
NAVY

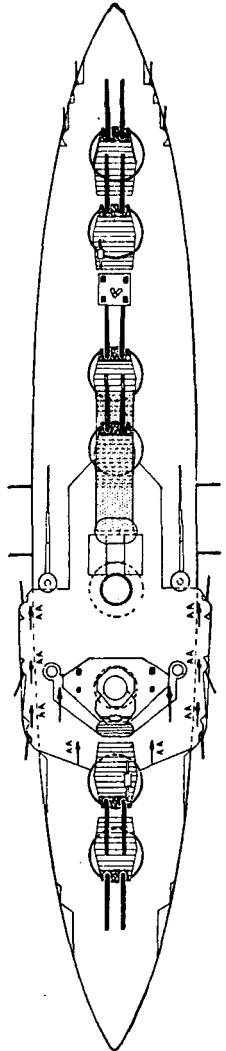
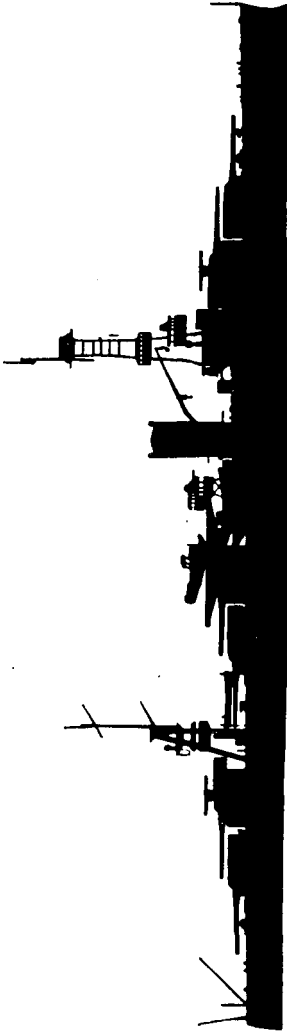

IDENTIFICATION OF U. S. NAVAL VESSELS

Battleship
ARKANSAS CLASS

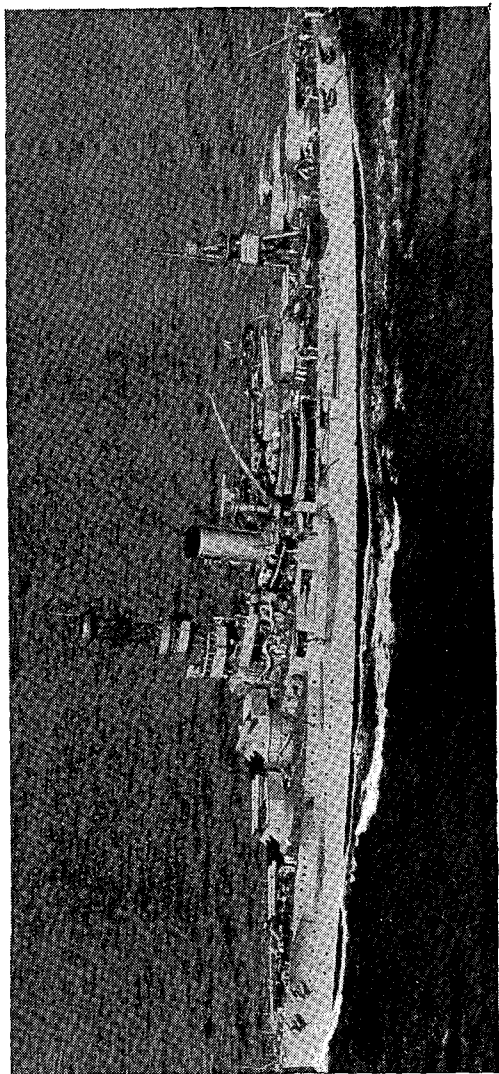

ARKANSAS

MILITARY INTELLIGENCE

UNITED STATES
NAVY

IDENTIFICATION OF U. S. NAVAL VESSELS

Battleship
NORTH CAROLINA CLASS

NORTH CAROLINA CLASS

NORTH CAROLINA
WASHINGTON
INDIANA
MASSACHUSETTS
ALABAMA
SOUTH DAKOTA

} Scheduled to be completed in 1942.

Description: Displacement, 35,000 tons.
Length, 750 feet.
Beam, 108 feet.
Draft, 36 feet (mean).
Speed, 28 knots.

Guns: 9 16-inch.
12 5-inch.
8 5-inch AA.

Torpedo tubes: None.

Airplanes: 4.

Catapults: 2.

Turrets: 3 3-gun.

MILITARY INTELLIGENCE

UNITED STATES
NAVY

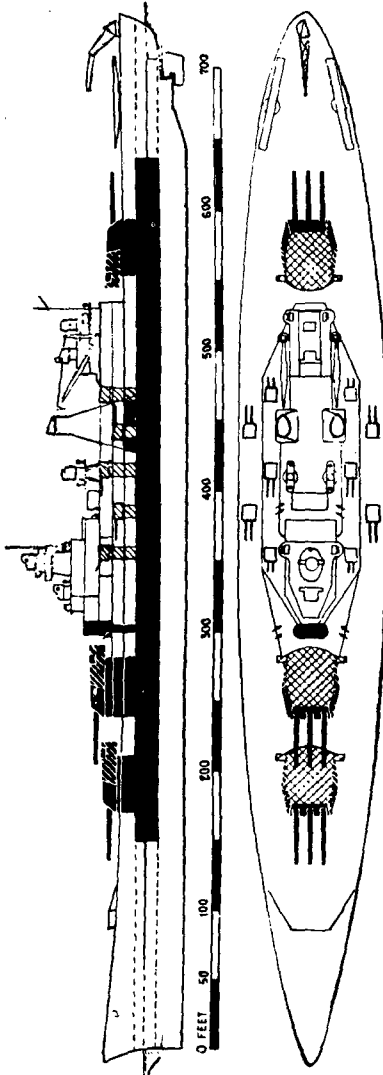

IDENTIFICATION OF U. S. NAVAL VESSELS

**Battleship
NORTH CAROLINA CLASS**

MILITARY INTELLIGENCE

UNITED STATES
NAVY

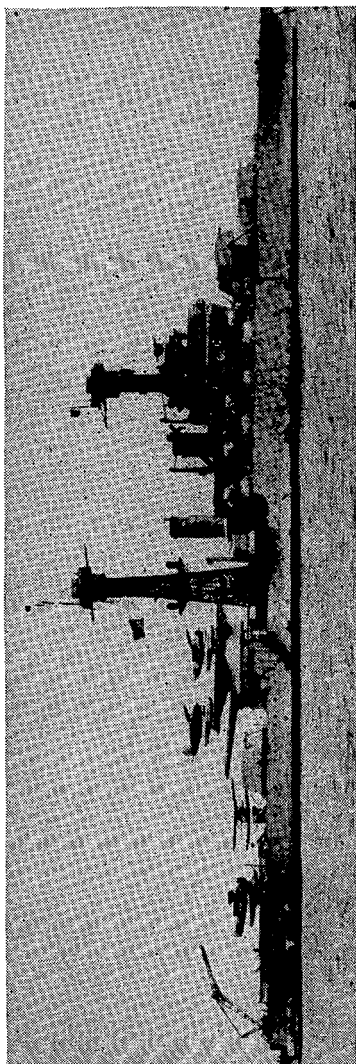

CALIFORNIA

IDENTIFICATION OF U. S. NAVAL VESSELS

Battleship
CALIFORNIA CLASS

CALIFORNIA CLASS

CALIFORNIA
TENNESSEE

Description: Displacement, 35,190 tons full load.
Length, 600 feet (water line).
Beam, 97½ feet.
Maximum draft, 35½ feet.
Speed, 21 knots.

Guns: 12 14-inch.
12 5-inch.
8 5-inch AA.
2 1-pounders.
2 machine guns.
11 machine guns AA.

Torpedo tubes: None.

Airplanes: 3. Catapults: 1 on No. 3 turret.
1 on quarter-deck.

Turrets: 4 3-gun.

MILITARY INTELLIGENCE

UNITED STATES
NAVY

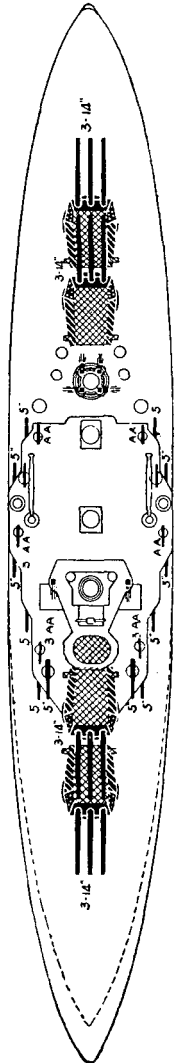
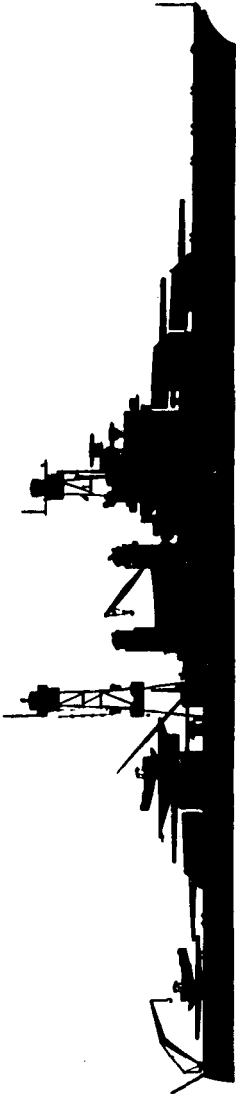

IDENTIFICATION OF U. S. NAVAL VESSELS

Battleship
CALIFORNIA CLASS

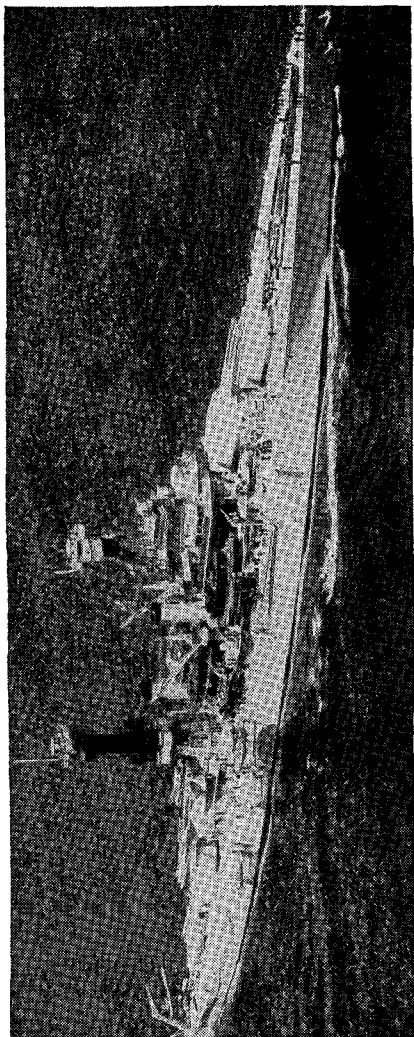

CALIFORNIA

SECTION III
AIRCRAFT CARRIERS

MILITARY INTELLIGENCE

UNITED STATES
NAVY

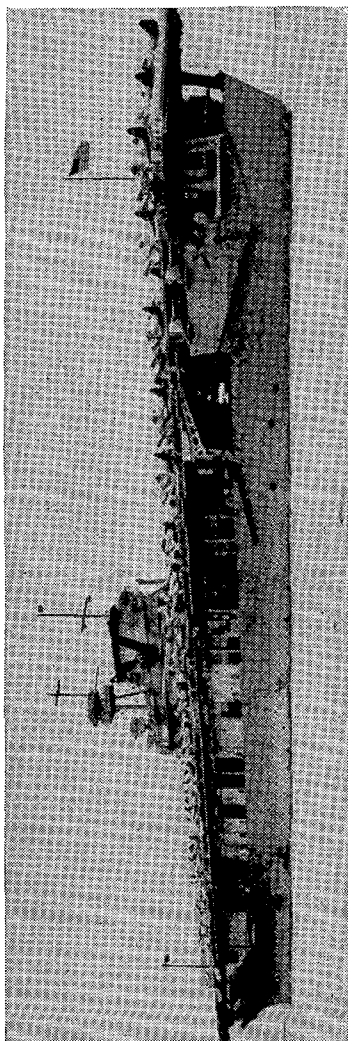

YORKTOWN

IDENTIFICATION OF U. S. NAVAL VESSELS

Aircraft carriers
ENTERPRISE—HORNET—YORKTOWN

ENTERPRISE
HORNET
YORKTOWN

Description: Displacement, 19,900 tons.

Length, 761 feet (water line).

Beam, 83¼ feet.

Draft, 21⅔ feet (mean).

*Recognition letters—EN, Enterprise; YT,
Yorktown.

Speed, 34 knots.

Guns: 8 5-inch AA.

16 machine guns.

16 machine guns AA.

Torpedo tubes:

Airplanes: 83 (space for over 100).

Catapults:

*Recognition letters are prominently painted on after end of flight deck.

MILITARY INTELLIGENCE

UNITED STATES
NAVY

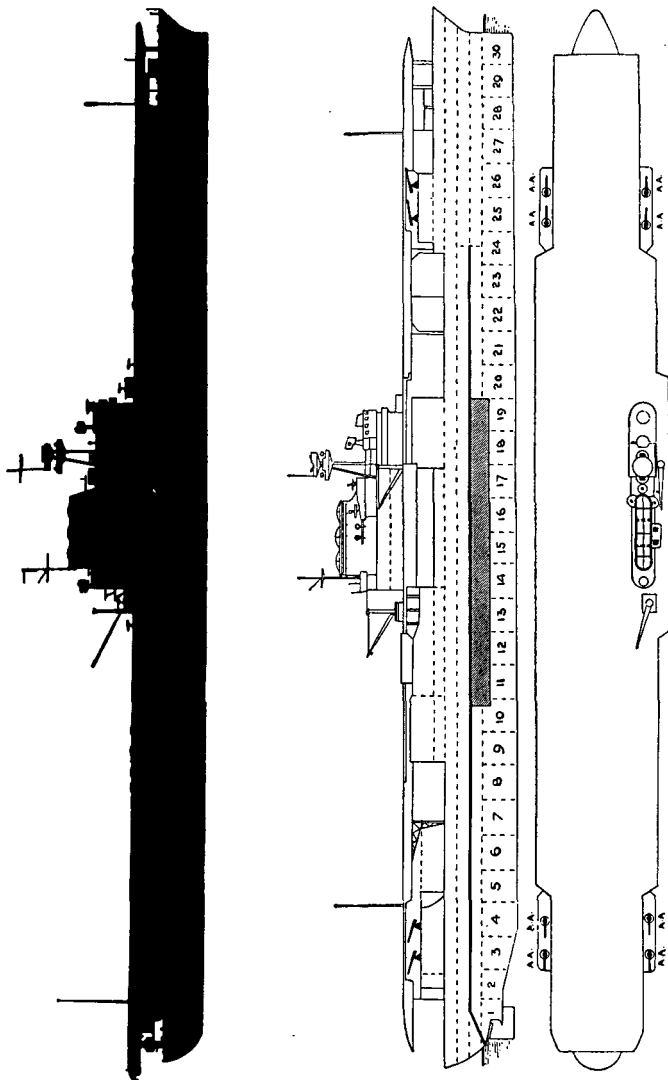

IDENTIFICATION OF U. S. NAVAL VESSELS

Aircraft carriers
ENTERPRISE—HORNET—YORKTOWN

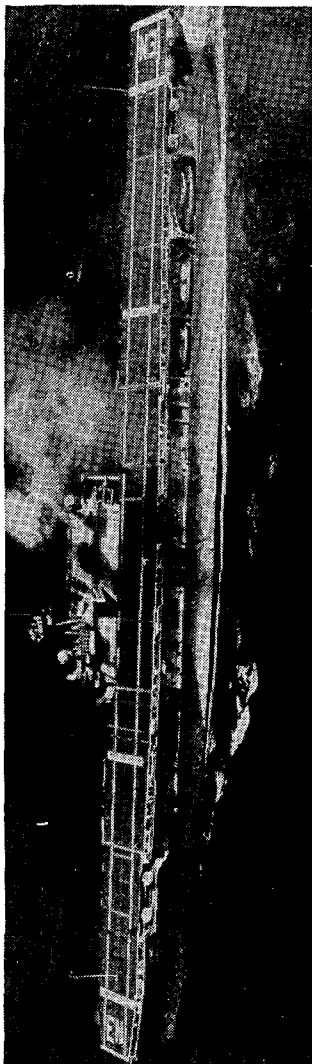

ENTERPRISE

MILITARY INTELLIGENCE

UNITED STATES
NAVY

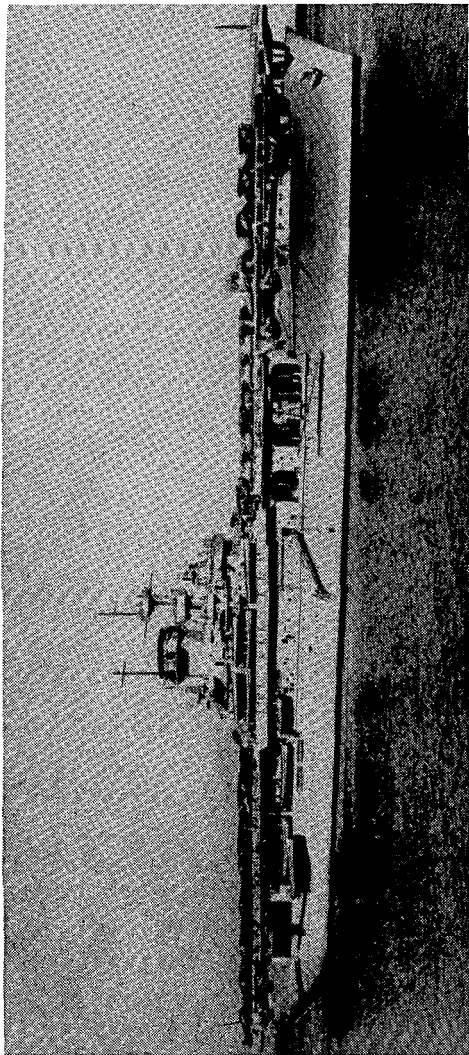

WASP

IDENTIFICATION OF U. S. NAVAL VESSELS

Aircraft carrier
WASP

WASP

Description: Displacement, 14,700 tons.
Length, 688 feet (water line).
Beam, $80\frac{4}{5}$ feet.
Draft, 20 feet (mean).

Guns: 8 5-inch AA.
40 smaller calibers.

Torpedo tubes:

Airplanes: 75. Catapults:

MILITARY INTELLIGENCE

UNITED STATES
NAVY

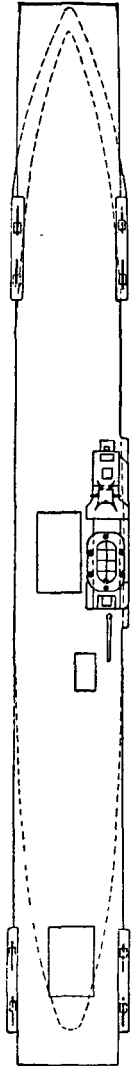

IDENTIFICATION OF U. S. NAVAL VESSELS

**Aircraft carrier
WASP**

UNITED STATES
NAVY

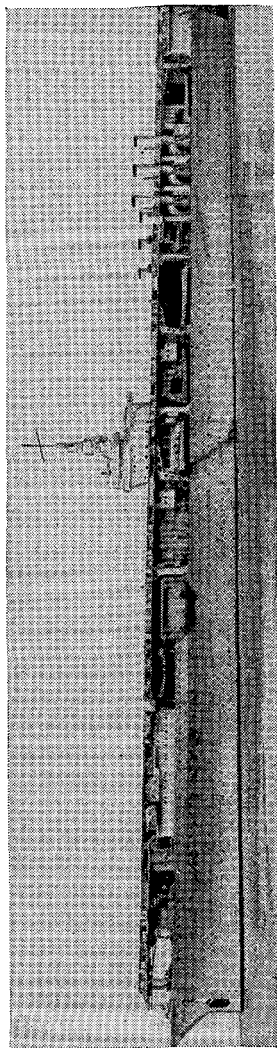

RANGER.

IDENTIFICATION OF U. S. NAVAL VESSELS

Aircraft carrier
RANGER CLASS

RANGER

Description: Displacement, 14,500 tons.
Length, 728 feet (water line).
Beam, $80\frac{1}{12}$ feet.
Draft, $19\frac{2}{3}$ feet (mean).
Recognition letters—RNGR.
Speed, $29\frac{1}{4}$ knots.

Guns: 8 5-inch AA.
40 smaller calibers.

Torpedo tubes:

Airplanes: 72 (space for 120). Catapults:

UNITED STATES
NAVY

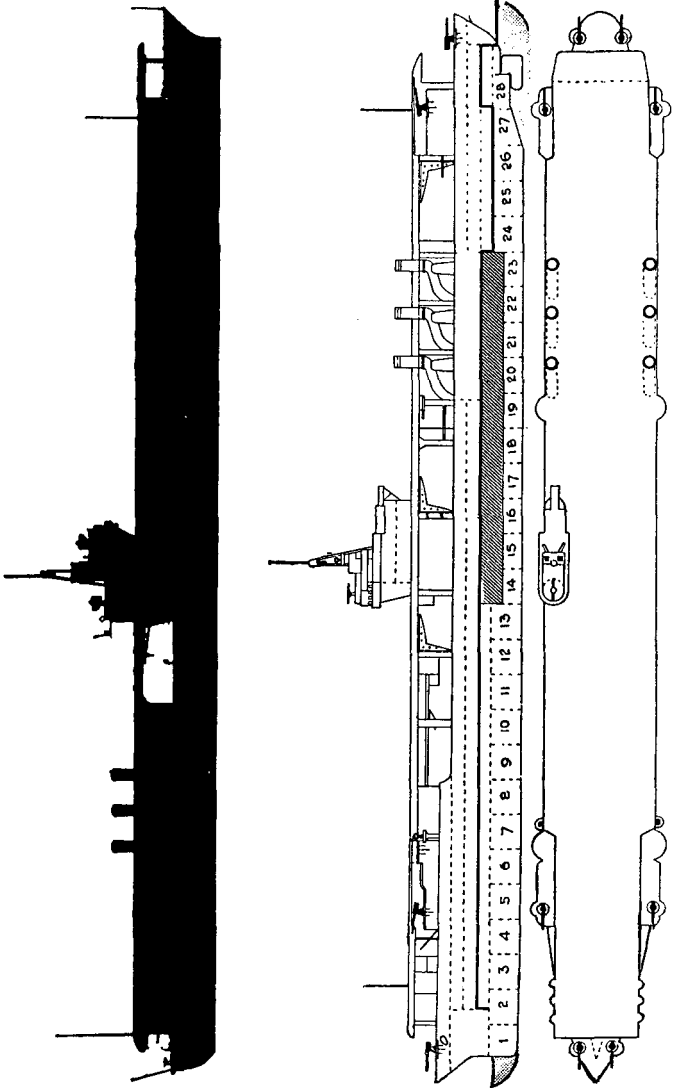

IDENTIFICATION OF U. S. NAVAL VESSELS

Aircraft carrier
RANGER CLASS

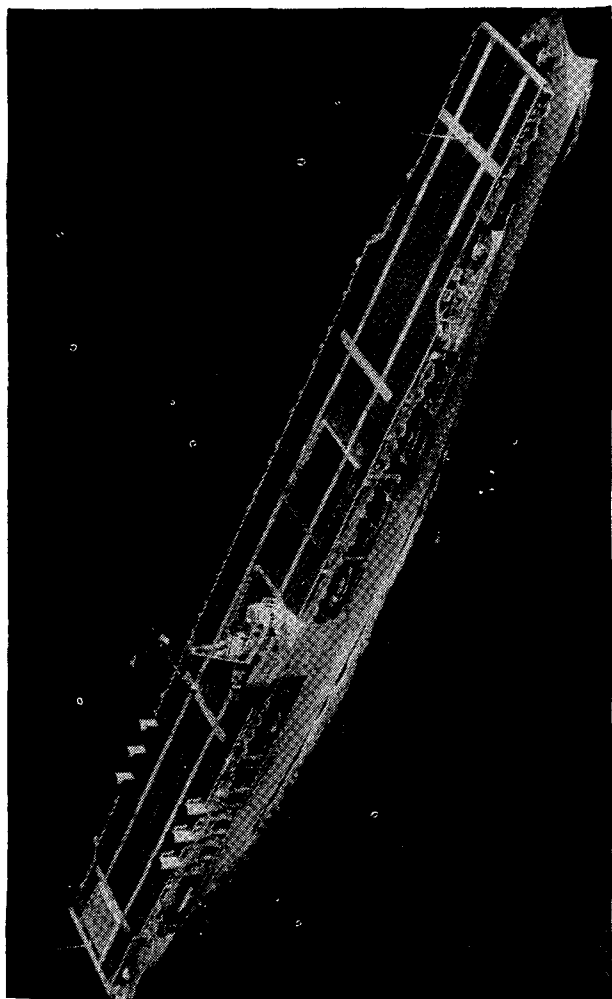

RANGER

MILITARY INTELLIGENCE

UNITED STATES
NAVY

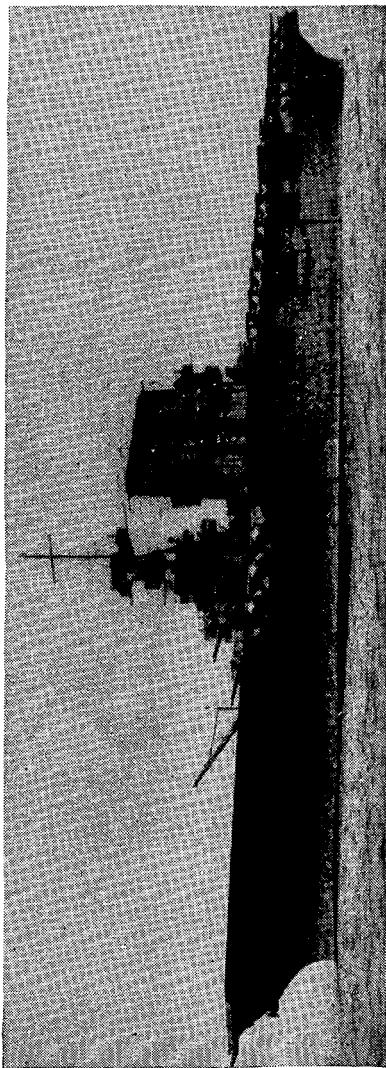

SARATOGA

IDENTIFICATION OF U. S. NAVAL VESSELS

Aircraft carrier
LEXINGTON-SARATOGA CLASS

LEXINGTON
SARATOGA

Description: Displacement, 33,000 tons.
Length, 830 feet (water line).
Beam, 105½ feet.
Maximum draft, 32 feet.
Recognition letters—LEX—Lexington.
SARA—Saratoga.
Speed, 33¼ knots.

Guns: 8 8-inch.
12 5-inch AA.
8 50-caliber machine guns.

Torpedo tubes:

Airplanes: Lexington, 90. Catapults: 1.
Saratoga, 79.

MILITARY INTELLIGENCE

UNITED STATES
NAVY

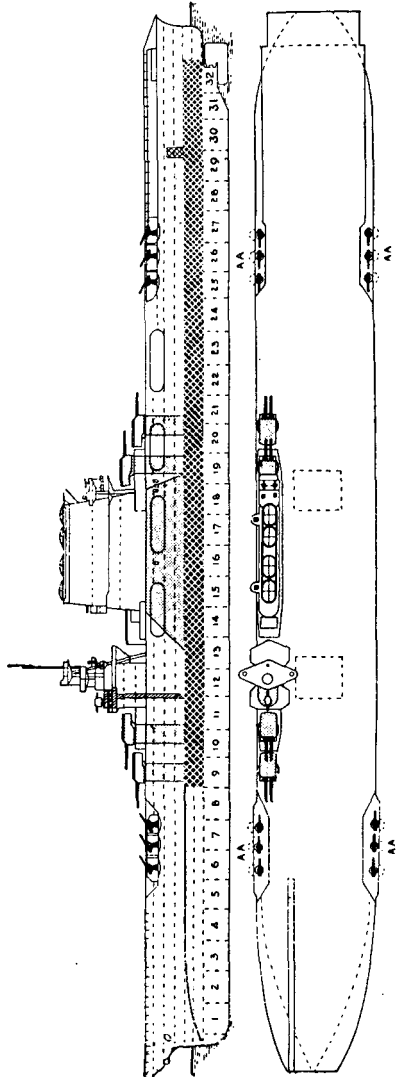
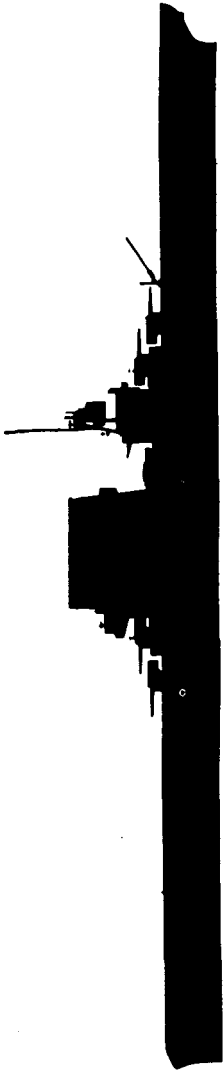

IDENTIFICATION OF U. S. NAVAL VESSELS

Aircraft carrier
LEXINGTON-SARATOGA CLASS

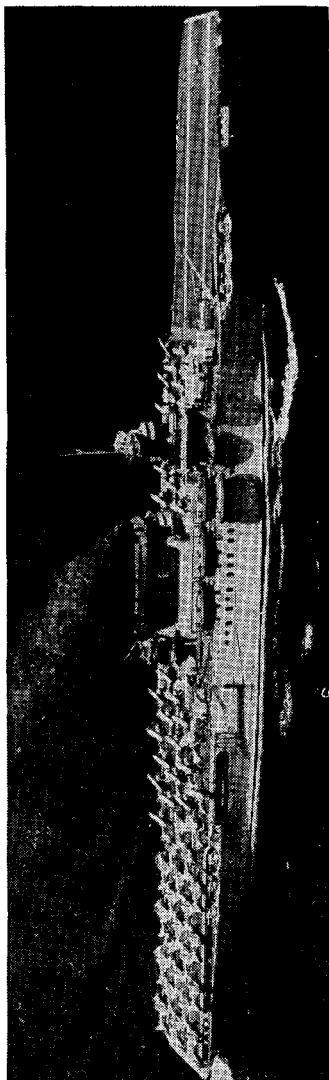

LEXINGTON

SECTION IV
HEAVY CRUISERS

MILITARY INTELLIGENCE

UNITED STATES
NAVY

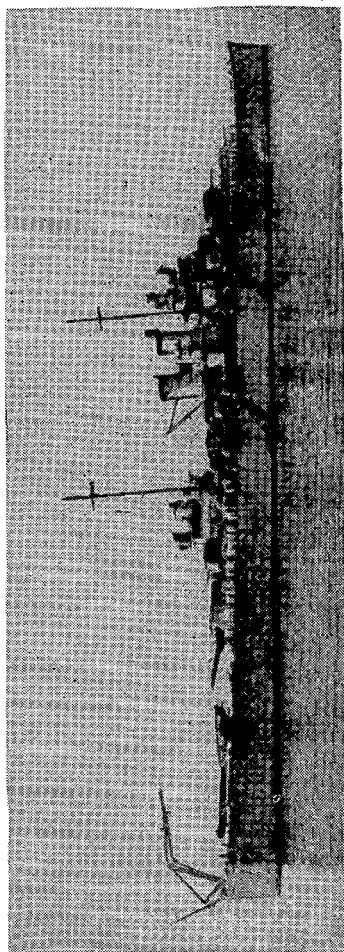

WICHITA

IDENTIFICATION OF U. S. NAVAL VESSELS

Heavy cruisers
WICHITA CLASS

WICHITA

Description: Displacement, 10,000 tons.
Length, 600 feet (water line).
Beam, 61 $\frac{3}{4}$ feet.
Draft, 19 $\frac{5}{6}$ feet (mean).
Speed, 32 $\frac{1}{2}$ knots.

Guns: 9 8-inch.
8 5-inch AA.
2 3-pounders.
10 smaller calibers.

Torpedo tubes:

Airplanes: 4. Catapults: 2.

Turrets: 3 3-gun.

Square stern.

UNITED STATES
NAVY

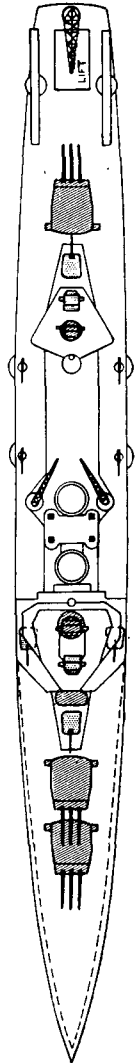
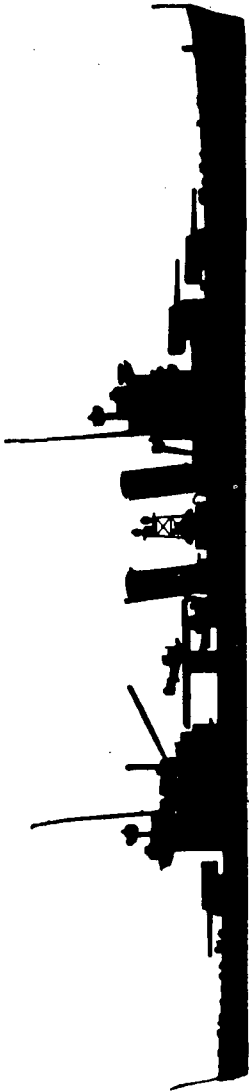

IDENTIFICATION OF U. S. NAVAL VESSELS

**Heavy cruisers
WICHITA CLASS**

MILITARY INTELLIGENCE

UNITED STATES
NAVY

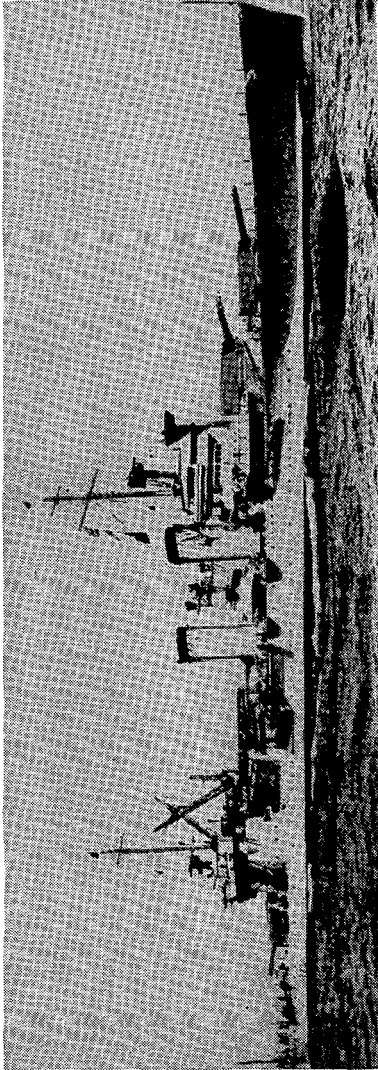

TUSCALOOSA

IDENTIFICATION OF U. S. NAVAL VESSELS

Heavy cruisers
NEW ORLEANS CLASS

NEW ORLEANS
ASTORIA
MINNEAPOLIS
SAN FRANCISCO
TUSCALOOSA

Description: Displacement, 9,950 tons.
 Length, 574 feet (water line).
 Beam, $61\frac{3}{4}$ feet.
 Maximum draft, $23\frac{1}{2}$ feet.
 Speed, $32\frac{7}{10}$ knots.

Guns: 9 8-inch,
 8 5-inch AA.
 2 3-pounders.
 10 smaller calibers.

Torpedo tubes:

Airplanes: 4.

Catapults: 2.

MILITARY INTELLIGENCE

UNITED STATES
NAVY

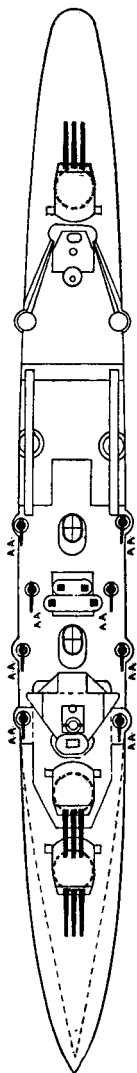
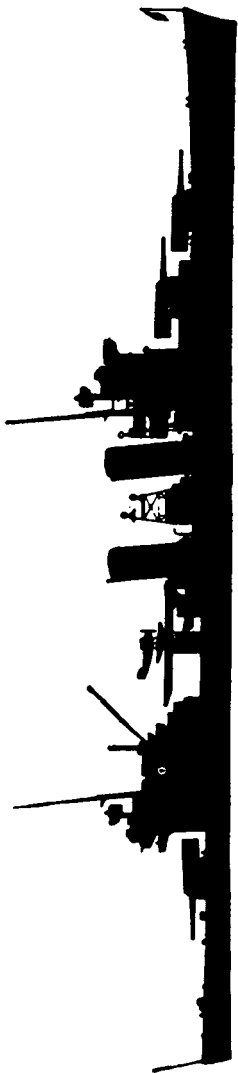

IDENTIFICATION OF U. S. NAVAL VESSELS

Heavy cruisers
NEW ORLEANS CLASS

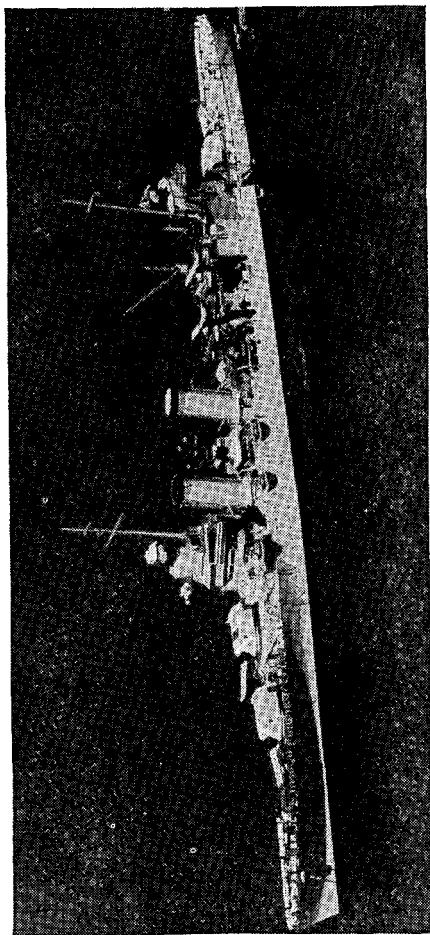

TUSCALOOSA

MILITARY INTELLIGENCE

UNITED STATES
NAVY

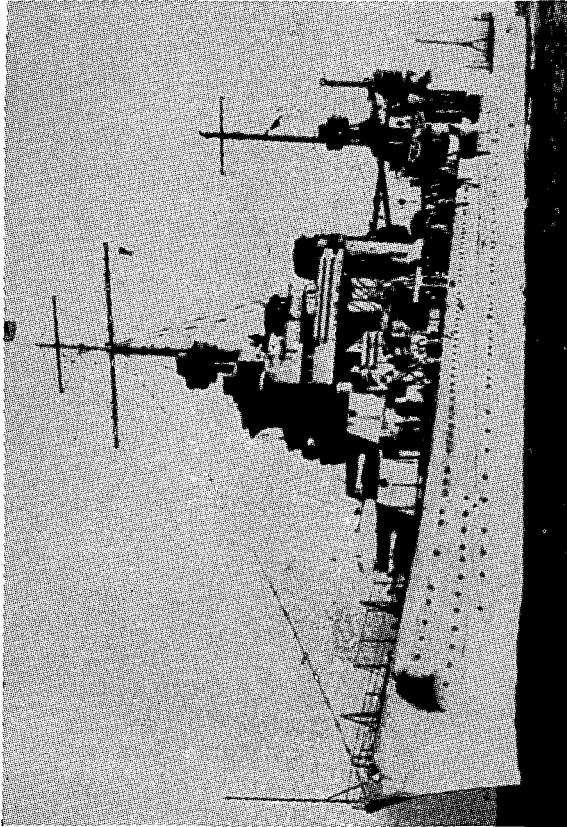

QUINCY

IDENTIFICATION OF U. S. NAVAL VESSELS

Heavy cruisers
QUINCY CLASS

QUINCY
VINCENNES

Description: Displacement, 9,375 tons.
Length, 569 feet (water line).
Beam, $61\frac{5}{6}$ feet.
Draft, $18\frac{2}{3}$ feet (mean).
Speed, $32\frac{7}{10}$ knots.

Guns: 9 8-inch.
8 5-inch AA.
2 3-pounders.
10 smaller calibers.

Torpedo tubes:

Airplanes: 4.

Catapults: 2.

MILITARY INTELLIGENCE

UNITED STATES
NAVY

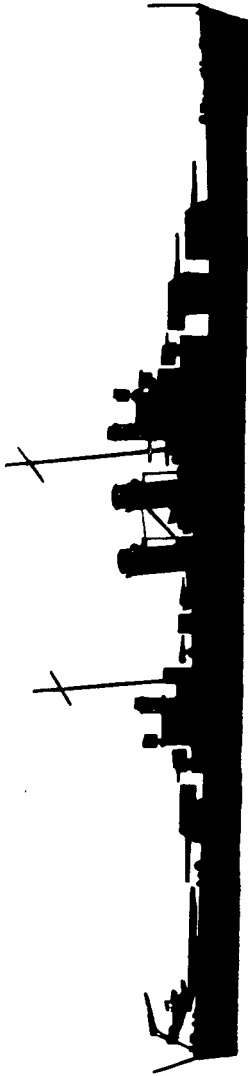

IDENTIFICATION OF U. S. NAVAL VESSELS

**Heavy cruisers
QUINCY CLASS**

MILITARY INTELLIGENCE

UNITED STATES
NAVY

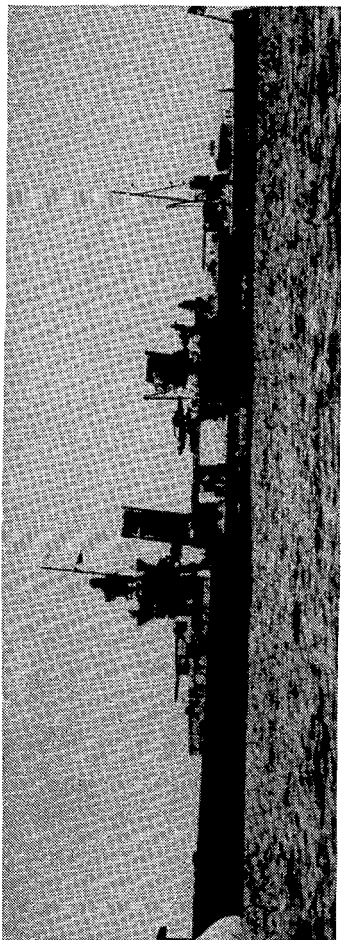

PORTLAND

IDENTIFICATION OF U. S. NAVAL VESSELS

Heavy cruisers
PORTLAND CLASS

PORTLAND
INDIANAPOLIS

Description: Displacement, 9,800 tons.
Length, 582 feet (water line).
Beam, 66 feet.
Draft, $17\frac{1}{2}$ feet (mean).
Speed, $32\frac{7}{10}$ knots.

Guns: 9 8-inch.
8 5-inch AA.
2 3-pounders.
10 smaller calibers.

Torpedo tubes:

Airplanes: Portland, 4.
Indianapolis, 5.

Catapults: 2.

MILITARY INTELLIGENCE

UNITED STATES
NAVY

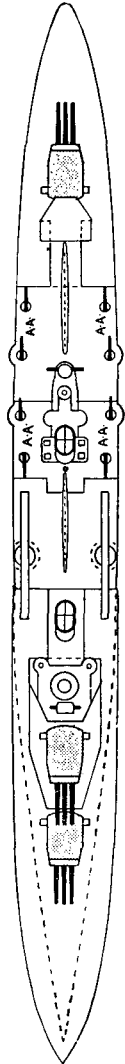
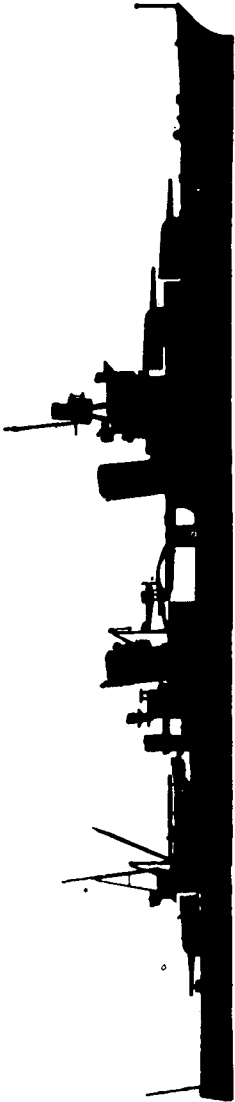

IDENTIFICATION OF U. S. NAVAL VESSELS

Heavy cruisers
PORTLAND CLASS

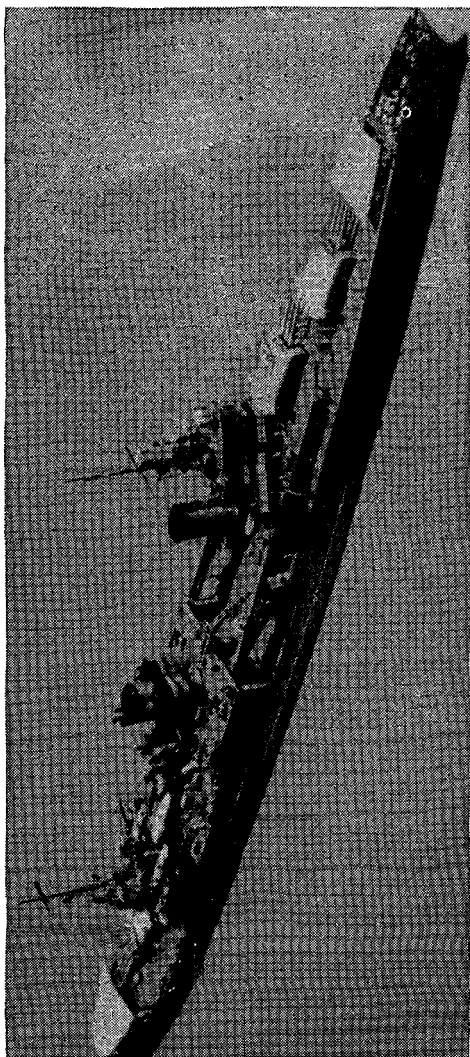

INDIANAPOLIS

MILITARY INTELLIGENCE

UNITED STATES
NAVY

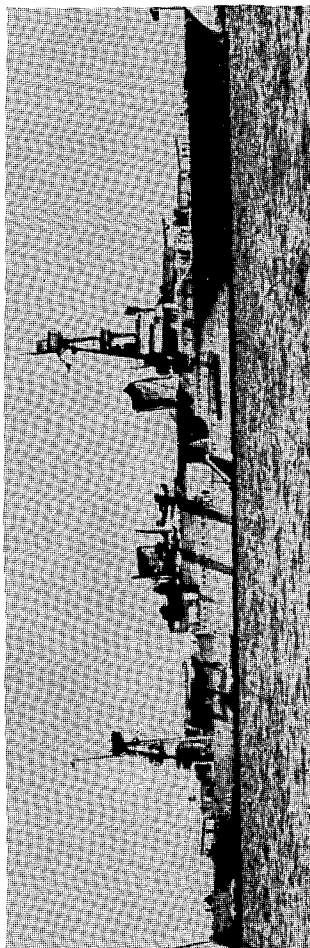

CHICAGO

IDENTIFICATION OF U. S. NAVAL VESSELS

Heavy cruisers
CHICAGO CLASS

CHICAGO
HOUSTON
AUGUSTA

Description: Displacement, 9,300 tons.
Length, 572 feet (water line).
Beam, $16\frac{2}{3}$ feet.
Maximum draft, 23 feet.
Speed, $32\frac{7}{10}$ knots.

Guns: 9 8-inch.
4 5-inch AA.
2 3-pounders.
8 machine guns.

Torpedo tubes:

Airplanes: 4.

Catapults: 2.

MILITARY INTELLIGENCE

UNITED STATES
NAVY

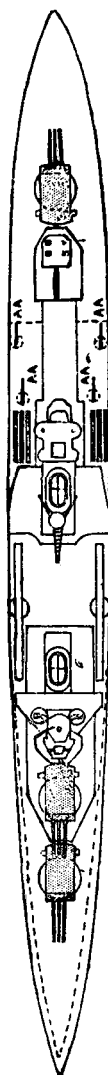
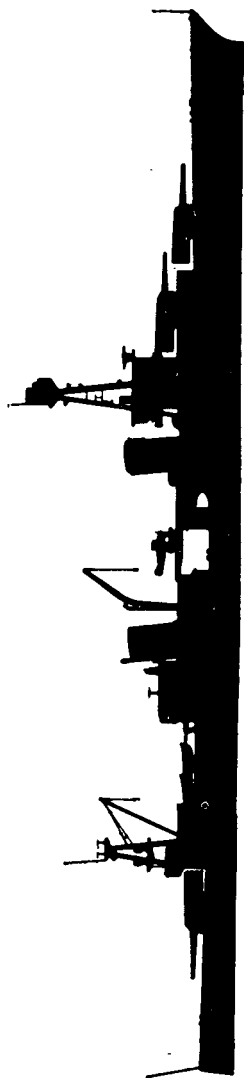

IDENTIFICATION OF U. S. NAVAL VESSELS

**Heavy cruisers
CHICAGO CLASS**

MILITARY INTELLIGENCE

UNITED STATES
NAVY

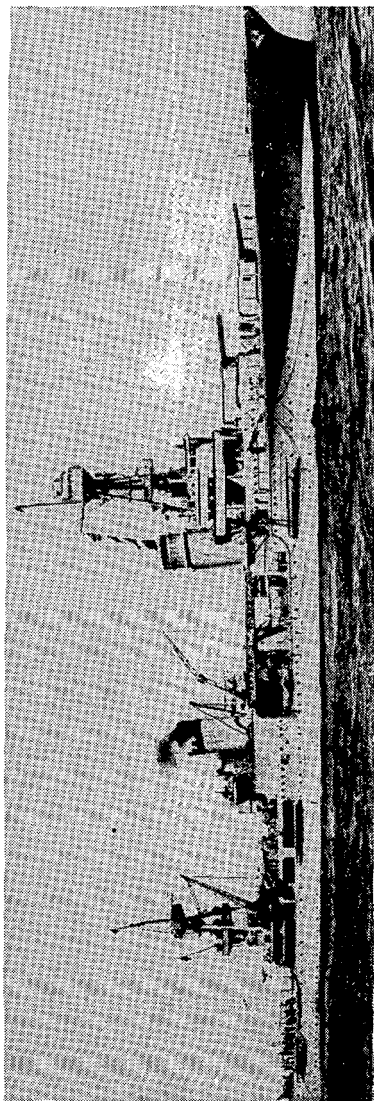

NORTHAMPTON

IDENTIFICATION OF U. S. NAVAL VESSELS

Heavy cruisers
NORTHAMPTON CLASS

NORTHAMPTON
CHESTER
LOUISVILLE

Description: Displacement, 9,200 tons.
 Length, 569 feet (water line).
 Beam, 66 feet.
 Maximum draft, 23 feet.
 Speed, $32\frac{7}{10}$ knots.

Guns: 9 8-inch.
 4 5-inch AA.
 2 3-pounders.
 8 machine guns.

Torpedo tubes:

Airplanes: 4.

Catapults: 2.

MILITARY INTELLIGENCE

UNITED STATES
NAVY

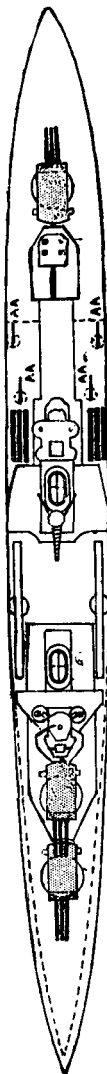
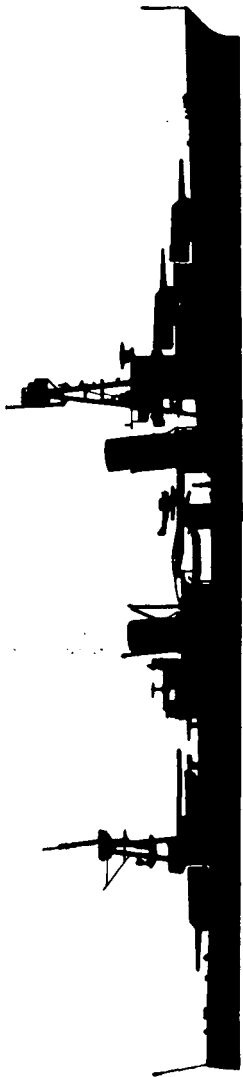

IDENTIFICATION OF U. S. NAVAL VESSELS

Heavy cruisers
NORTHAMPTON CLASS

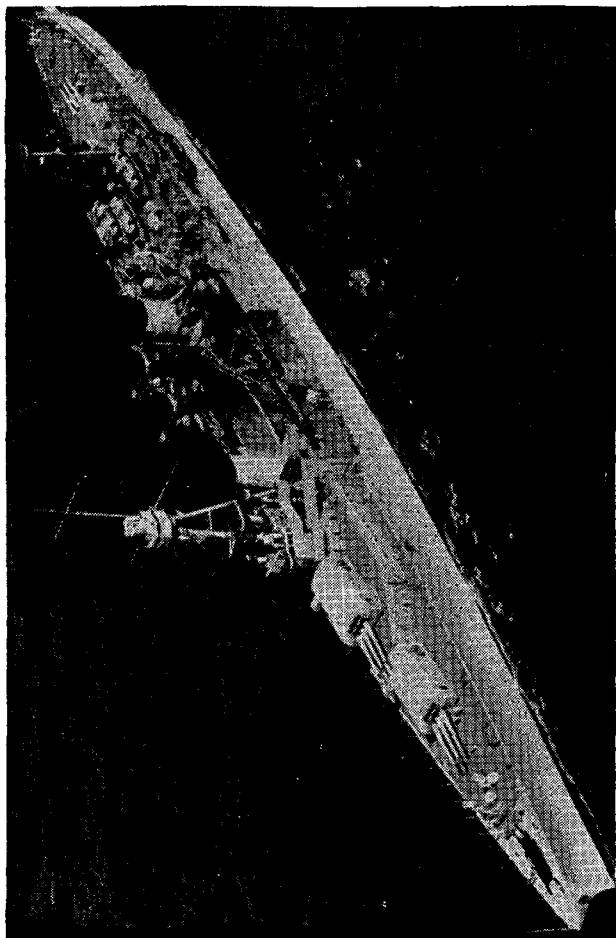

LOUISVILLE

MILITARY INTELLIGENCE

UNITED STATES
NAVY

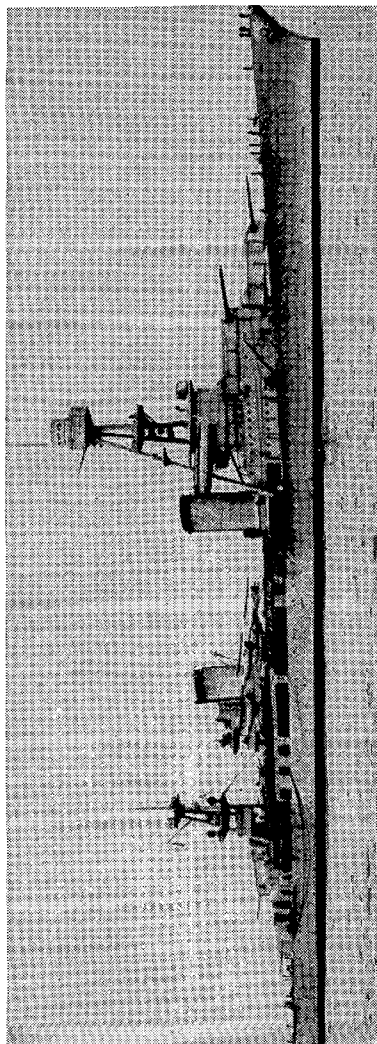

PENSACOLA

IDENTIFICATION OF U. S. NAVAL VESSELS

Heavy cruisers
PENSACOLA CLASS

PENSACOLA
SALT LAKE CITY

Description: Displacement, 9,100 tons.
Length, 558 feet (water line).
Beam, 65 $\frac{1}{4}$ feet.
Maximum draft, 22 feet.
Speed, 32 $\frac{7}{10}$ knots.

Guns: 10 8-inch.
4 5-inch AA.
2 3-pounders.

Torpedo tubes:

Airplanes: 4.

Catapults: 2.

UNITED STATES
NAVY

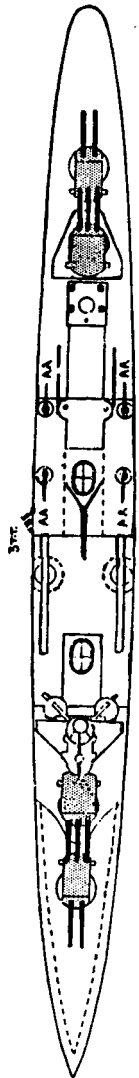
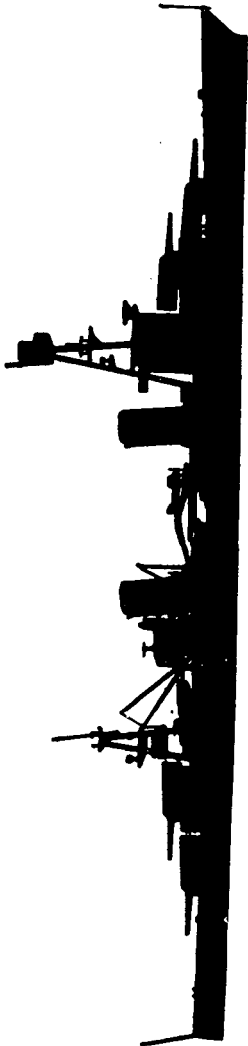

IDENTIFICATION OF U. S. NAVAL VESSELS

Heavy cruisers
PENSACOLA CLASS

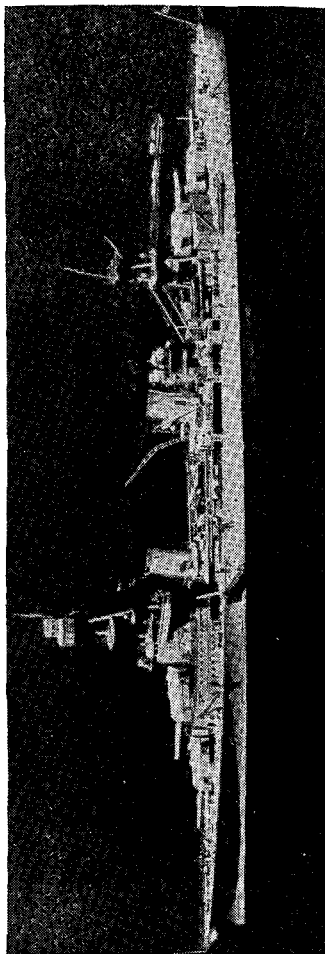

PENSACOLA

SECTION V
LIGHT CRUISERS

MILITARY INTELLIGENCE

UNITED STATES
NAVY

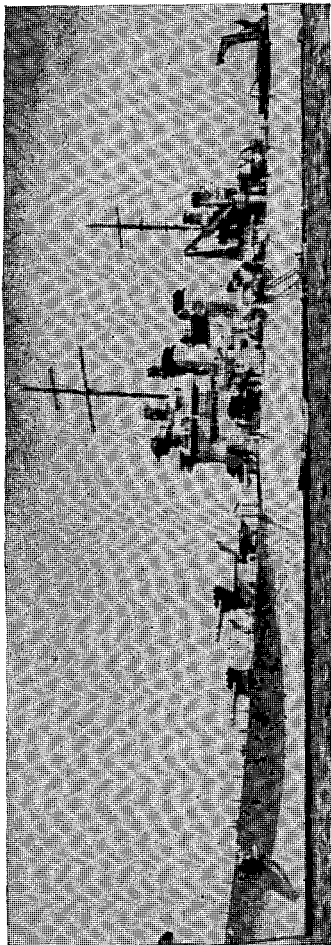

BROOKLYN

IDENTIFICATION OF U. S. NAVAL VESSELS

Light cruisers
BROOKLYN CLASS

BROOKLYN

Description: Displacement, 9,700 tons.
 Length, 600 feet (water line).
 Beam, 61½ feet.
 Draft, 19¾ feet (mean).
 Speed, 32½ knots.

Guns: 15 6-inch.
 8 5-inch AA.
 4 3-pounders.
 3 machine guns.

Torpedo tubes:

Airplanes: 4 (space for 8). Catapults: 2.

Turrets: 5 3-gun.

Square stern.

UNITED STATES
NAVY

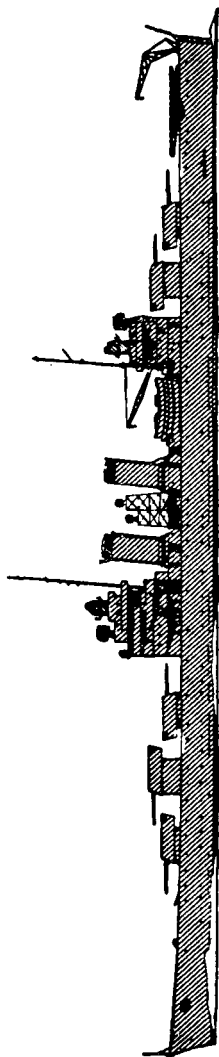

(Plan same as Philadelphia Class)

IDENTIFICATION OF U. S. NAVAL VESSELS

**Light cruisers
BROOKLYN CLASS**

UNITED STATES
NAVY

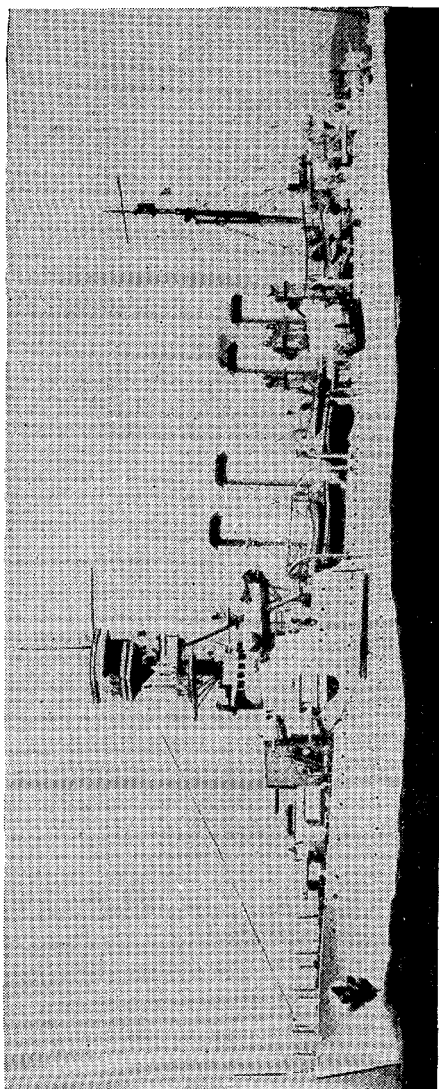

CINCINNATI

IDENTIFICATION OF U. S. NAVAL VESSELS

Light cruisers
OMAHA CLASS

OMAHA	MILWAUKEE
RALEIGH	DETROIT
CONCORD	TRENTON
MEMPHIS	RICHMOND
MARBLEHEAD	CINCINNATI

Description: Displacement, 7,050 tons.
Length, 550 feet (water line).
Beam, 55 $\frac{1}{3}$ feet.
Maximum draft, 20 feet.
Speed, 35 knots.

Guns: Concord, Memphis, Milwaukee, Omaha,
Trenton, 12 6-inch.
All others, 10 6-inch.
8 machine guns AA.

Torpedo tubes:

Airplanes: 4.

Catapults: 2.

MILITARY INTELLIGENCE

UNITED STATES
NAVY

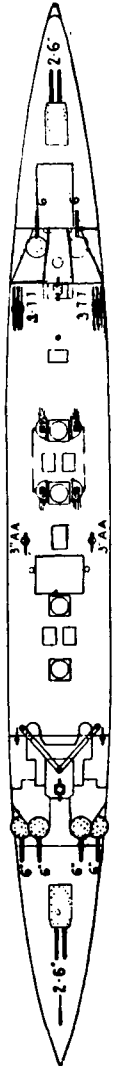
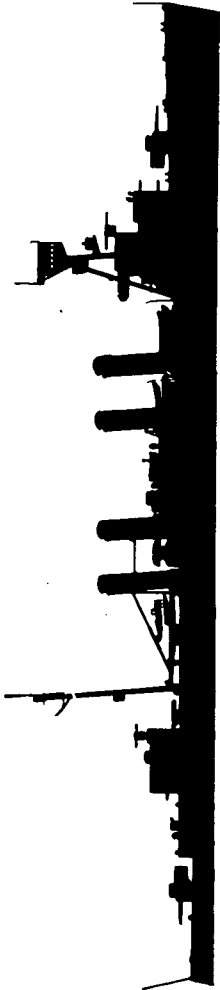

IDENTIFICATION OF U. S. NAVAL VESSELS

Light cruisers
OMAHA CLASS

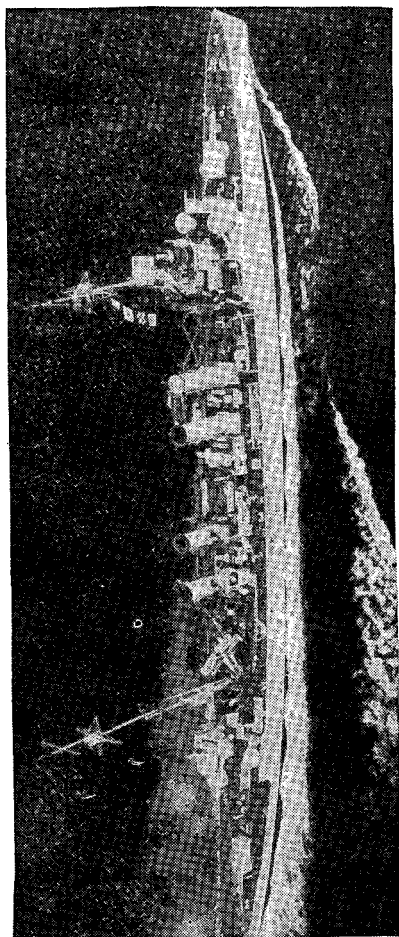

MARBLEHEAD

MILITARY INTELLIGENCE

**UNITED STATES
NAVY**

IDENTIFICATION OF U. S. NAVAL VESSELS

Light cruisers
PHILADELPHIA CLASS

PHILADELPHIA
SAVANNAH
NASHVILLE

Description: Displacement, 10,000 tons.
Length, 600 feet (water line).
Beam, 61½ feet.
Draft, 19¾ feet (mean).
Speed, 32½ knots.

Guns: 15 6-inch.
8 5-inch AA.
4 3-pounders.
3 machine guns.

Torpedo tubes:

Airplanes: 4 (space for 8).

Catapults: 2.

UNITED STATES
NAVY

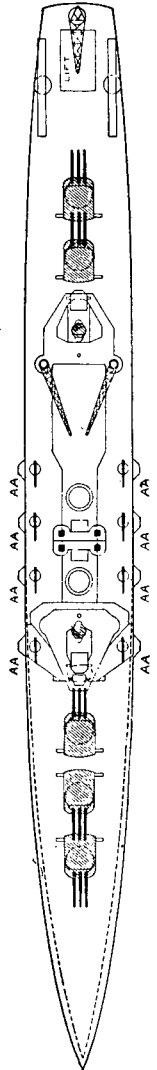

IDENTIFICATION OF U. S. NAVAL VESSELS

Light cruisers
PHILADELPHIA CLASS

MILITARY INTELLIGENCE

UNITED STATES
NAVY

IDENTIFICATION OF U. S. NAVAL VESSELS

Light cruisers
PHOENIX CLASS

PHOENIX
BOISE
HONOLULU

Description: Displacement, 10,000 tons.
Length, 600 feet (water line).
Beam, 61½ feet.
Draft, 19¾ feet (mean).
Speed, 32½ knots.

Guns: 15 6-inch.
8 5-inch AA.
4 3-pounders.
3 machine guns.

Torpedo tubes:

Airplanes: 4 (space for 8).

Catapults: 2.

UNITED STATES
NAVY

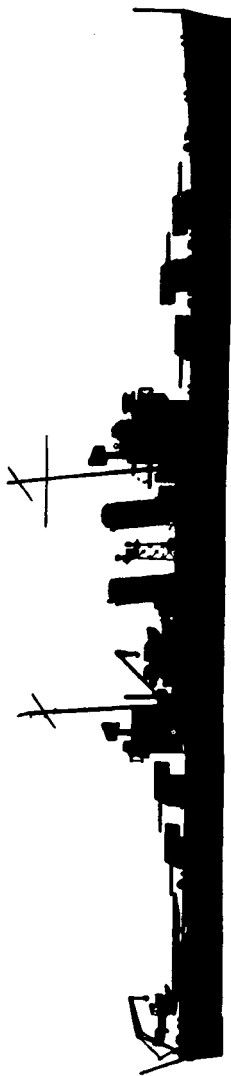

(Plan same as Philadelphia Class)

IDENTIFICATION OF U. S. NAVAL VESSELS

Light cruisers
PHOENIX CLASS

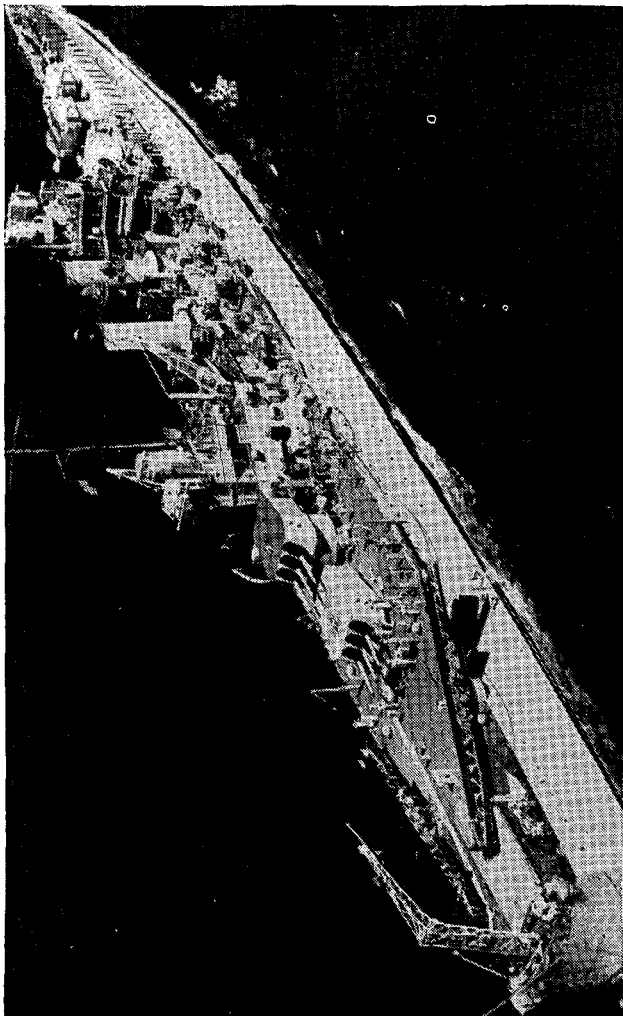

HONOLULU

MILITARY INTELLIGENCE

UNITED STATES
NAVY

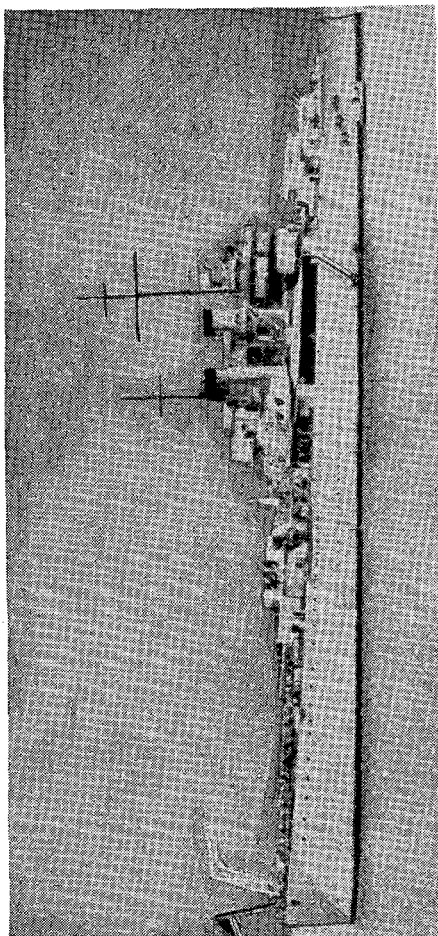

ST. LOUIS

IDENTIFICATION OF U. S. NAVAL VESSELS

Light cruisers
ST. LOUIS CLASS

ST. LOUIS
HELENA

Description: Displacement, 10,000 tons.
Length, 600 feet (water line).
Beam, 61½ feet.
Draft, 19¾ feet (mean).
Speed, 32½ knots.

Guns: 15 6-inch.
8 5-inch AA.
4 3-pounders.
3 machine guns.

Torpedo tubes:

Airplanes: 4 (space for 8). Catapults: 2.

MILITARY INTELLIGENCE

UNITED STATES
NAVY

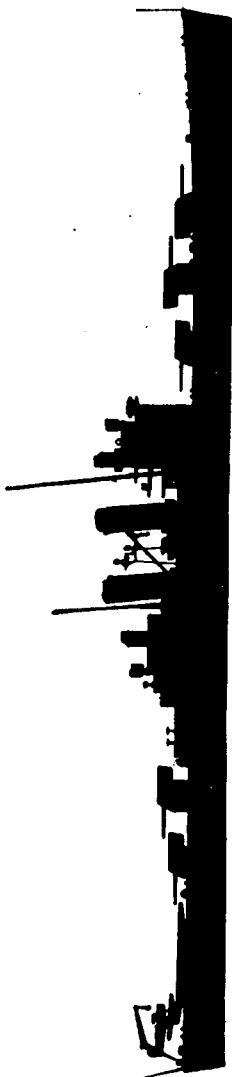

(Plan same as Philadelphia Class)

IDENTIFICATION OF U. S. NAVAL VESSELS

Light cruisers
ST. LOUIS CLASS

SECTION VI
DESTROYERS

MILITARY INTELLIGENCE

UNITED STATES
NAVY

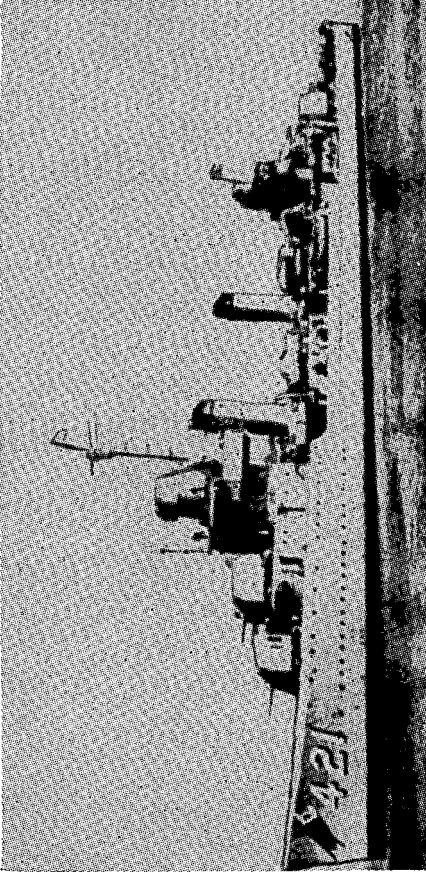

BENSON

IDENTIFICATION OF U. S. NAVAL VESSELS

Destroyers
BENSON CLASS

BENSON	421	GWIN	433
MAYO	422	MEREDITH	434
GLEAVES	423	LIVERMORE	435
NIBLACK	424	MONSSEN	436
MADISON	425	WOOLSEY	437
LANSDALE	426	LUDLOW	438
HILARY P. JONES	427	EDISON	439
C. F. HUGHES	428	ERICSSON	440
GRAYSON	429	WILKES	441
EBERLE	430	NICHOLSON	442
PLUNKETT	431	SWANSON	443
KEARNY	432	INGRAHAM	444

Description: Displacement, 1,630 tons.

Length, —.

Beam, —.

Draft, —.

Speed, 36½ knots.

Guns: 6 5-inch

Torpedo tubes: 10.

MILITARY INTELLIGENCE

UNITED STATES
NAVY

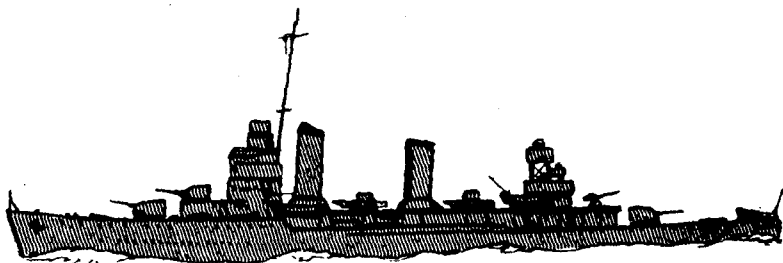

BENSON CLASS, 421-444 (earlier units)

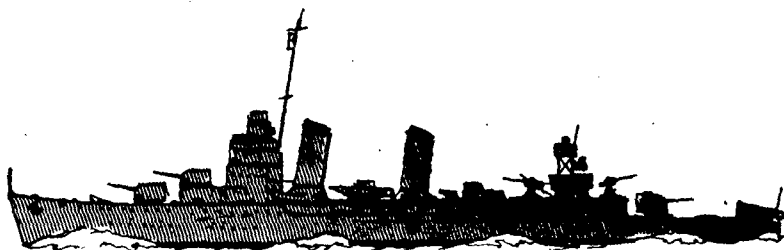

BENSON CLASS, 421-444 (later units)



IDENTIFICATION OF U. S. NAVAL VESSELS

**Destroyers
BENSON CLASS**

MILITARY INTELLIGENCE

UNITED STATES
NAVY

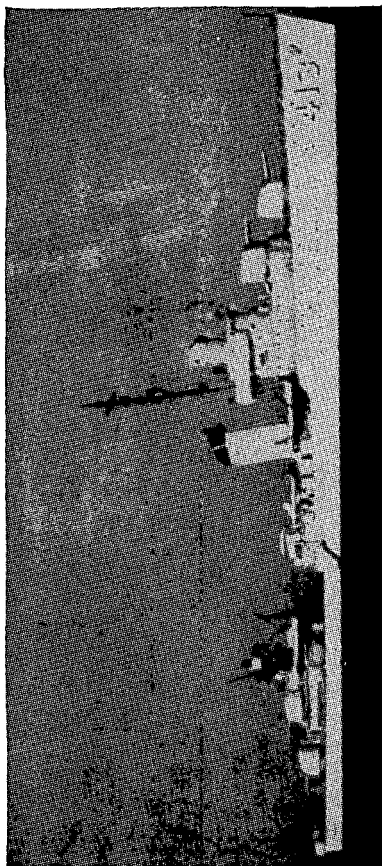

MUSTIN

IDENTIFICATION OF U. S. NAVAL VESSELS

Destroyers
SIMS CLASS

SIMS	409	O'BRIEN	415
HUGHES	410	WALKE	416
ANDERSON	411	MORRIS	417
HAMMANN	412	ROE	418
MUSTIN	413	WAINWRIGHT	419
RUSSELL	414	BUCK	420

Description: Displacement, 1,570 tons.

Length, —.

Beam, —.

Draft, —.

Speed, 36½ knots.

Guns: 5 5-inch.

Torpedo tubes: 12.

MILITARY INTELLIGENCE

UNITED STATES
NAVY

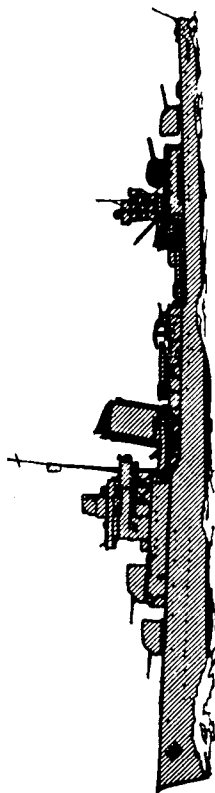

SIMS CLASS, 409-420

IDENTIFICATION OF U. S. NAVAL VESSELS

Destroyers
SIMS CLASS

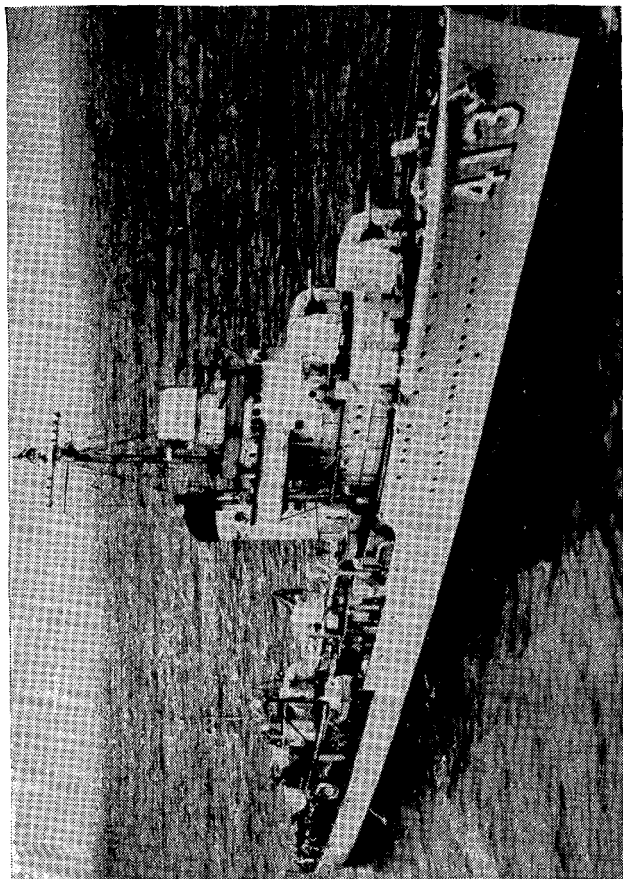

MUSTIN

MILITARY INTELLIGENCE

UNITED STATES
NAVY

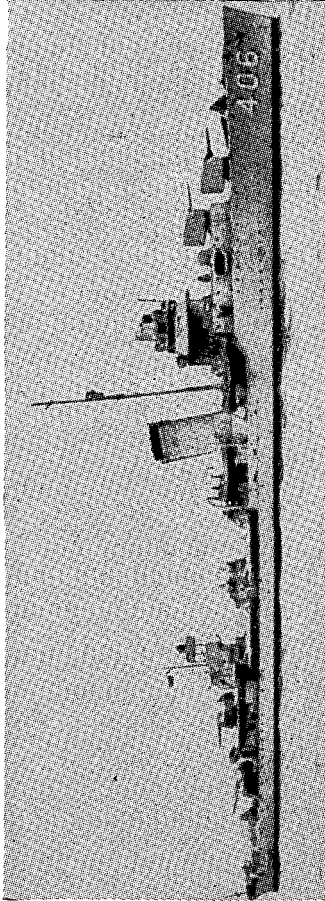

STACK

IDENTIFICATION OF U. S. NAVAL VESSELS

Destroyers
GRIDLEY CLASS

GRIDLEY	380	ELLET	398
CRAVEN	382	LANG	399
BAGLEY	386	MC CALL	400
BLUE	387	MAURY	401
HELM	388	MAYRANT	402
MUGFORD	389	TRIPPE	403
RALPH TALBOT	390	RHIND	404
HENLEY	391	ROWAN	405
PATTERSON	392	STACK	406
JARVIS	393	STERETT	407
BENHAM	397	WILSON	408

Description: Displacement, 1,500 tons.
 Length, 334 feet (water line).
 Beam, $34\frac{2}{3}$ feet.
 Draft, $9\frac{5}{8}$ feet (mean).
 Speed, $36\frac{1}{2}$ knots.

Guns: 4 5-inch.
 4 machine guns.

Torpedo tubes: 16.

MILITARY INTELLIGENCE

UNITED STATES
NAVY

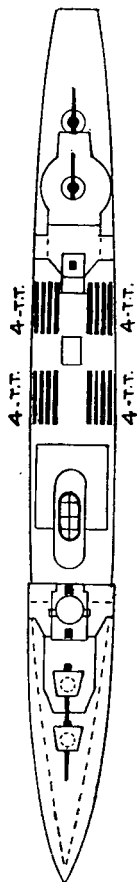
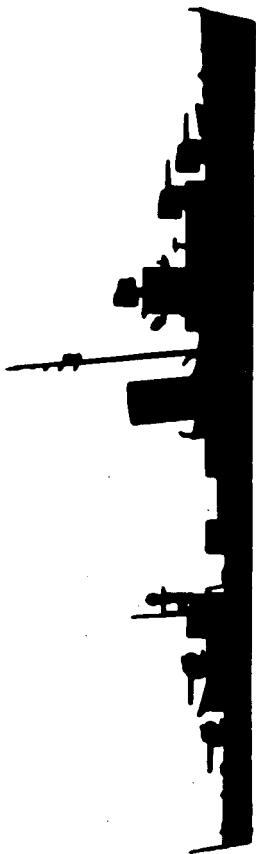

IDENTIFICATION OF U. S. NAVAL VESSELS

Destroyers
GRIDLEY CLASS

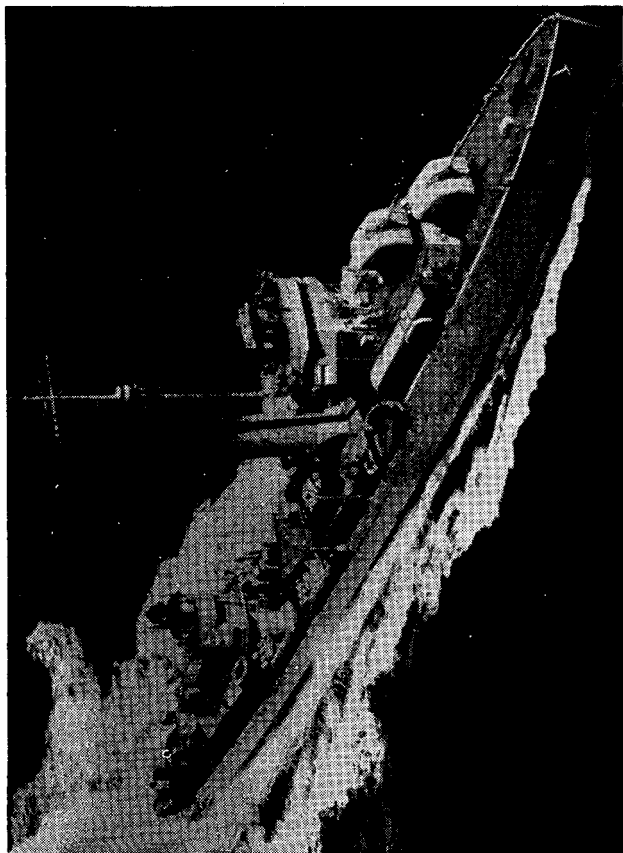

ROWAN

MILITARY INTELLIGENCE

UNITED STATES
NAVY

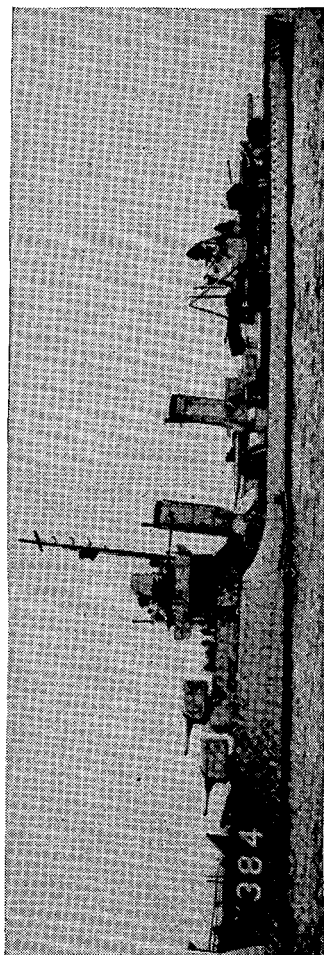

DUNLAP

IDENTIFICATION OF U. S. NAVAL VESSELS

Destroyers
DUNLAP CLASS

DUNLAP 384

FANNING 385

Description: Displacement, 1,490 tons.
 Length, 334 feet (water line).
 Beam, $34\frac{5}{6}$ feet.
 Draft, $9\frac{5}{6}$ feet (mean).
 Speed, $36\frac{1}{2}$ knots.

Guns: 5 5-inch.
 4 machine guns.

Torpedo tubes: 12.

MILITARY INTELLIGENCE

UNITED STATES
NAVY

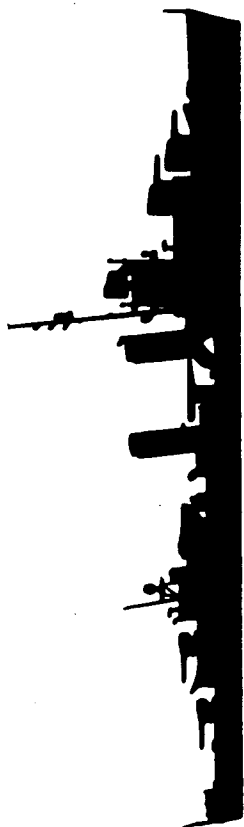

IDENTIFICATION OF U. S. NAVAL VESSELS

Destroyers
DUNLAP CLASS

MILITARY INTELLIGENCE

UNITED STATES
NAVY

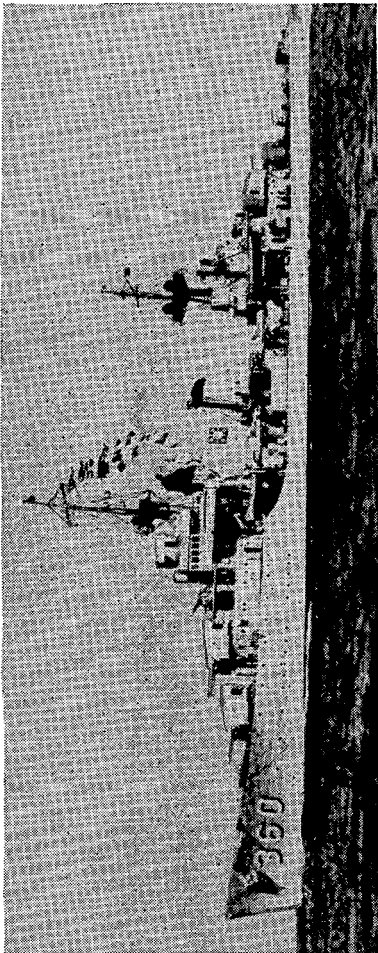

PHELPS

IDENTIFICATION OF U. S. NAVAL VESSELS

Destroyers
PORTER CLASS

PORTER	356	PHELPS	360
SELFRIDGE	357	CLARK	361
MC DOUGAL	358	MOFFETT	362
WINSLOW	359	BALCH	363

Description: Displacement, 1,850 tons.
 Length, 371 feet (water line).
 Beam, $36\frac{1}{6}$ feet.
 Draft, $10\frac{1}{4}$ (mean).
 Speed, 37 knots.

Guns: 8 5-inch.
 3 1-pounders.
 2 machine guns.

Torpedo tubes: 8.

MILITARY INTELLIGENCE

UNITED STATES
NAVY

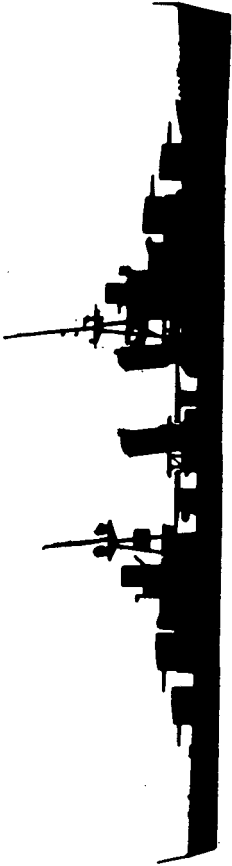

IDENTIFICATION OF U. S. NAVAL VESSELS

Destroyers
PORTER CLASS

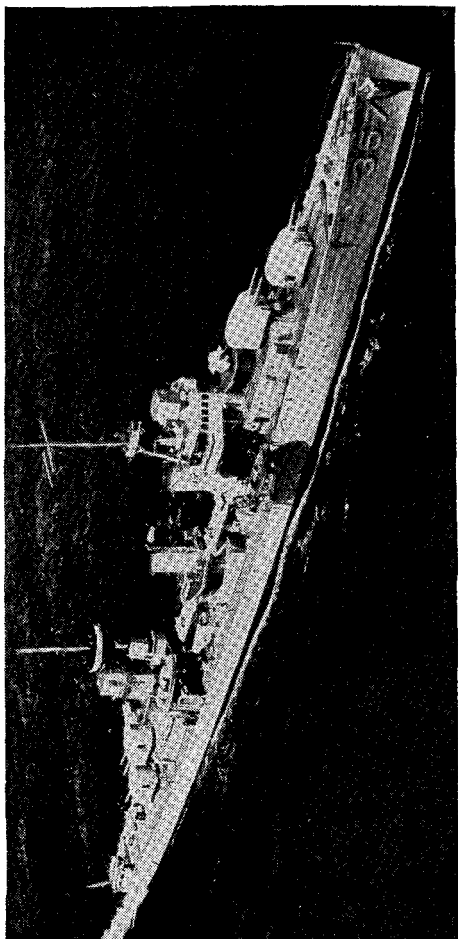

SELFRIDGE

MILITARY INTELLIGENCE

UNITED STATES
NAVY

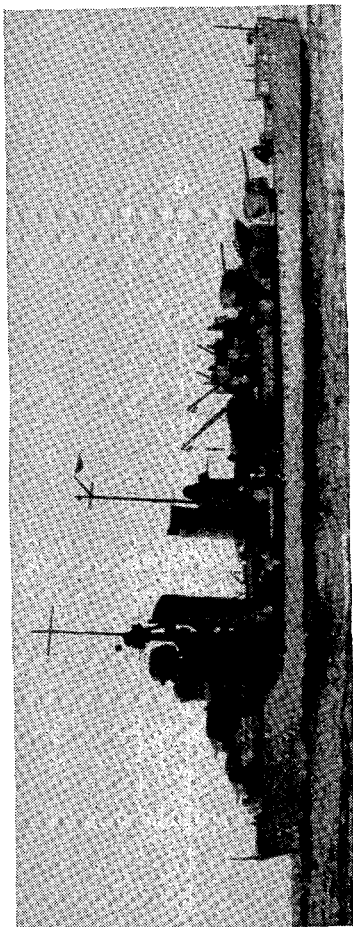

CUMMINGS

IDENTIFICATION OF U. S. NAVAL VESSELS

Destroyers
MAHAN CLASS

MAHAN	364	CASSIN	372
CUMMINGS	365	SHAW	373
DRAYTON	366	TUCKER	374
LAMSON	367	DOWNES	375
FLUSSER	368	CUSHING	376
REID	369	PERKINS	377
CASE	370	SMITH	378
CONYNGHAM	371	PRESTON	379

Description: Displacement, 1,500 tons.
 Length, 334 feet (water line).
 Beam, $34\frac{2}{3}$ feet.
 Maximum draft, 17 feet.
 Speed, $36\frac{1}{2}$ knots.

Guns: 5 5-inch.
 4 machine guns.

Torpedo tubes: 12.

UNITED STATES
NAVY

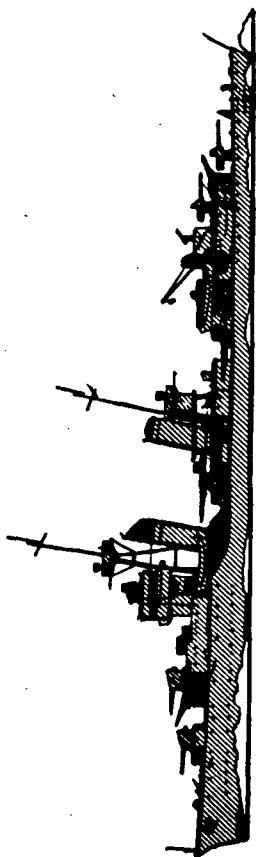

MAHAN CLASS

(Some lack clinker screen to fore funnel)



IDENTIFICATION OF U. S. NAVAL VESSELS

Destroyers
MAHAN CLASS

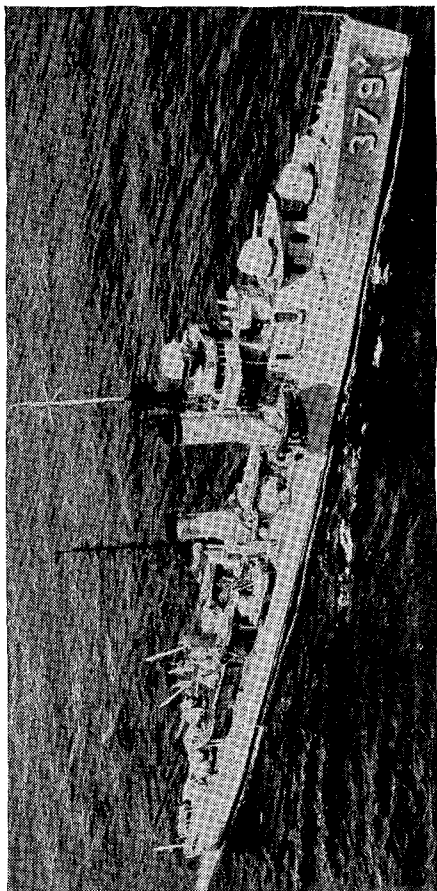

PRESTON

MILITARY INTELLIGENCE

UNITED STATES
NAVY

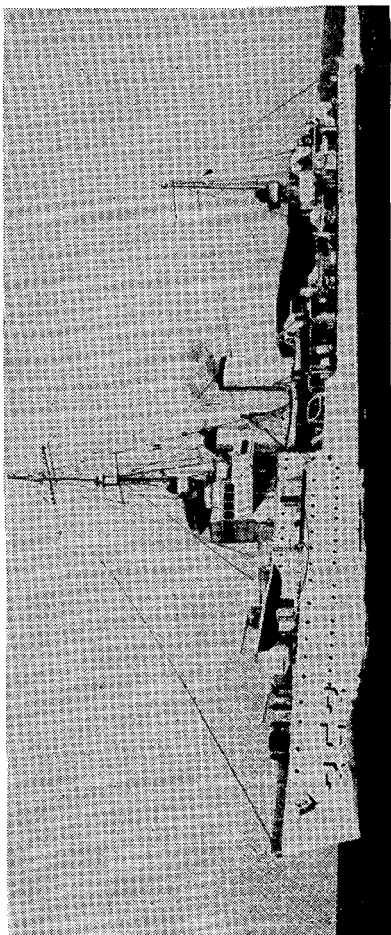

DALE

IDENTIFICATION OF U. S. NAVAL VESSELS

Destroyers
FARRAGUT CLASS

FARRAGUT	348	WORDEN	352
DEWEY	349	DALE	353
HULL	350	MONAGHAN	354
MAC DONOUGH	351	AYLWIN	355

Description: Displacement, 1,395 tons.
 Length, 331 feet (water line).
 Beam, 34 $\frac{1}{6}$ feet.
 Maximum draft, 15 $\frac{1}{2}$ feet.
 Speed, 36 knots.

Guns: 5 5-inch.
 4 machine guns.

Torpedo tubes: 8.

MILITARY INTELLIGENCE

UNITED STATES
NAVY

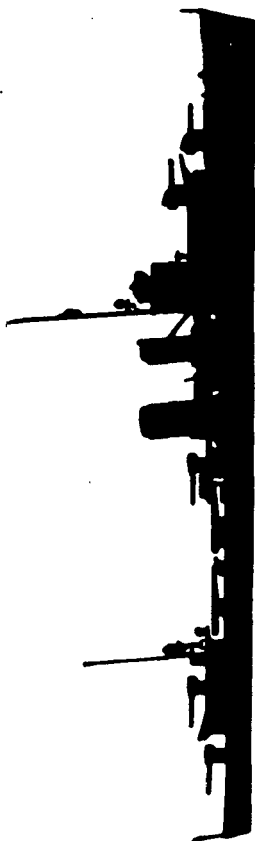

IDENTIFICATION OF U. S. NAVAL VESSELS

Destroyers
FARRAGUT CLASS

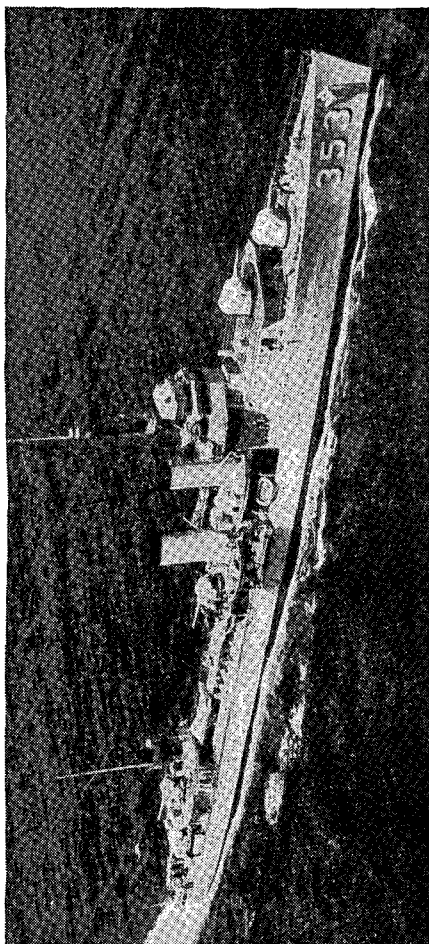

DALE

MILITARY INTELLIGENCE

UNITED STATES
NAVY

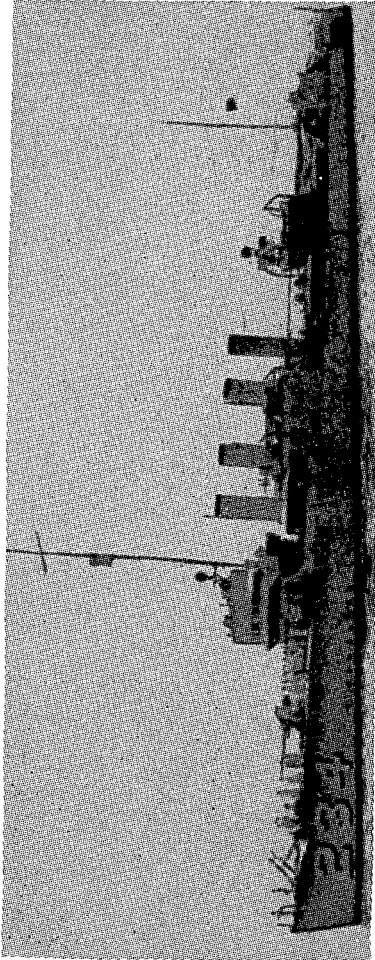

FOX

IDENTIFICATION OF U. S. NAVAL VESSELS

Destroyers
FARRAGUT CLASS

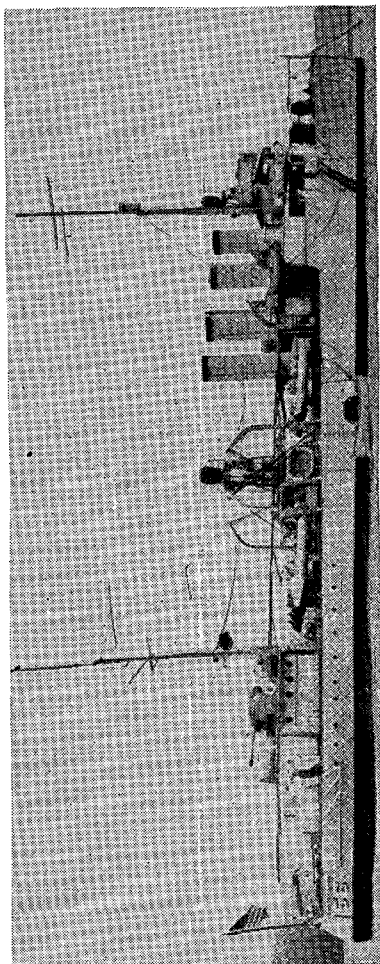

J. FRED TALBOTT

MILITARY INTELLIGENCE

**UNITED STATES
NAVY**

IDENTIFICATION OF U. S. NAVAL VESSELS

Destroyers
FLUSH DECK CLASS

SCHLEY	103	ALDEN	211
CHEW	106	BARKER	213
CRANE	109	BORIE	215
RATHBURNE	113	JOHN D. EDWARDS	216
TALBOT	114	WHIPPLE	217
WATERS	115	PARROTT	218
DENT	116	EDSALL	219
LEA	118	MAC LEISH	220
TATTNALL	125	SIMPSON	221
BADGER	126	BULMER	222
BABBITT	128	MC CORMICK	223
JACOB JONES	130	STEWART	224
KILTY	137	POPE	225
KENNISON	138	PEARY	226
WARD	139	PILLSBURY	227
HAMILTON	141	JOHN D. FORD	228
TARBELL	142	TRUXTUN	229
UPSHUR	144	PAUL JONES	230
GREER	145	HATFIELD	231
ROPER	147	BROOKS	232
BRECKINRIDGE	148	GILMER	233
BARNEY	149	FOX	234
BLAKELEY	150	KANE	235
BIDDLE	151	HUMPHREYS	236
DU PONT	152	OVERTON	239
BERNADOU	153	STURTEVANT	240
ELLIS	154	KING	242
COLE	155	SANDS	243
J. FRED TALBOTT	156	REUBEN JAMES	245
DICKERSON	157	BAINBRIDGE	246
LEARY	158	GOFF	247
SCHENK	159	BARRY	248
HERBERT	160	LAWRENCE	250
CROSBY	164	LITCHFIELD	336
DAHLGREN	197	ZANE	337
DALLAS	199	DECATUR	341
BROOME	210	NOA	343
		ALLEN	—

MILITARY INTELLIGENCE

**UNITED STATES
NAVY**

IDENTIFICATION OF U. S. NAVAL VESSELS

Destroyers
FLUSH DECK CLASS

Description: Displacement, 1,100 tons.
 Length, 310 feet (water line).
 Beam, $30\frac{2}{3}$ feet.
 Maximum draft, $13\frac{1}{2}$ feet.
 Speed, 35 knots.

Guns: 4 4-inch.
 1 3-inch AA.

Torpedo tubes: 12.

MILITARY INTELLIGENCE

UNITED STATES
NAVY

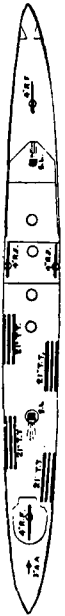
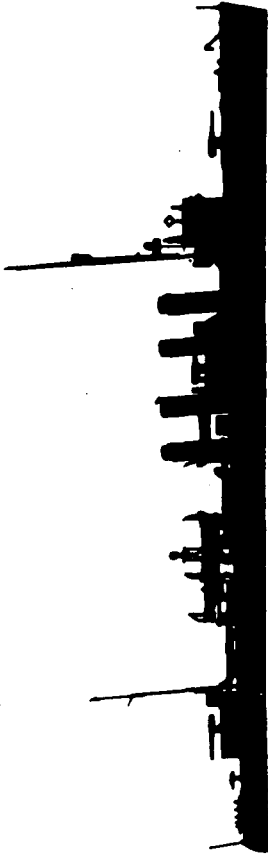

IDENTIFICATION OF U. S. NAVAL VESSELS

Destroyers
FLUSH DECK CLASS

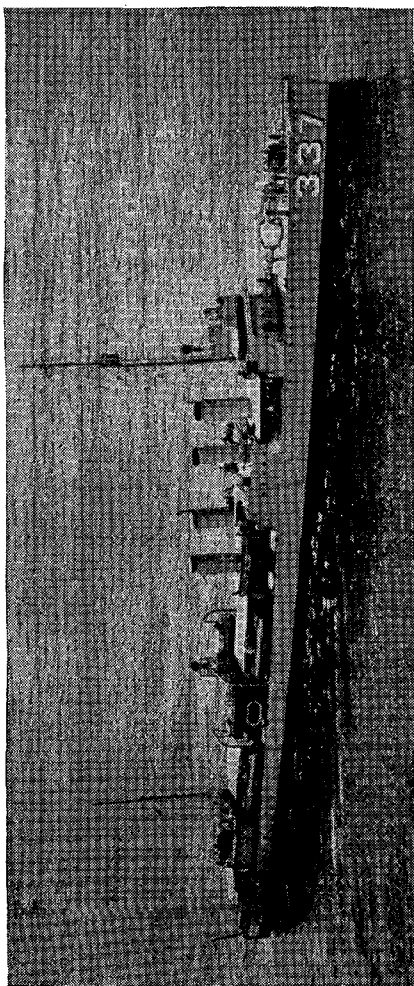

ZANE

MILITARY INTELLIGENCE

UNITED STATES
NAVY

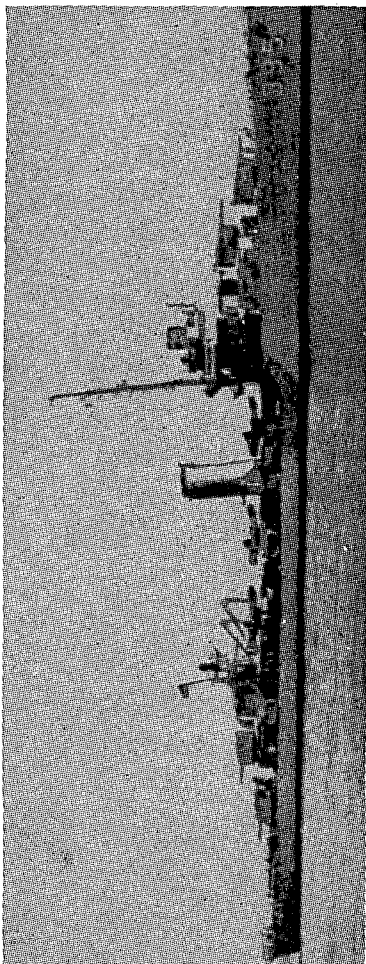

DAVIS

IDENTIFICATION OF U. S. NAVAL VESSELS

Destroyers
SOMERS CLASS

SOMERS	381	DAVIS	395
WARRINGTON	383	JOUETT	396
SAMPSON	394		

Description: Displacement, 1,850 tons.
 Length, 371 feet (water line).
 Beam, $36\frac{1}{6}$ feet.
 Draft, $10\frac{1}{4}$ feet (mean).
 Speed, 37 knots.

Guns:
 8 5-inch.
 8 1-pounders.
 2 machine guns.

Torpedo tubes: 12.

MILITARY INTELLIGENCE

UNITED STATES
NAVY

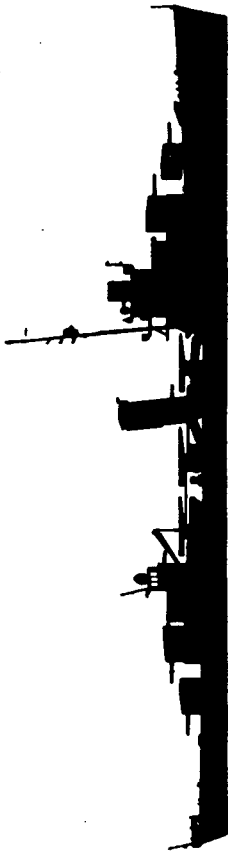

IDENTIFICATION OF U. S. NAVAL VESSELS

**Destroyers
SOMERS CLASS**

SECTION VII
MINE LAYERS

MILITARY INTELLIGENCE

UNITED STATES
NAVY

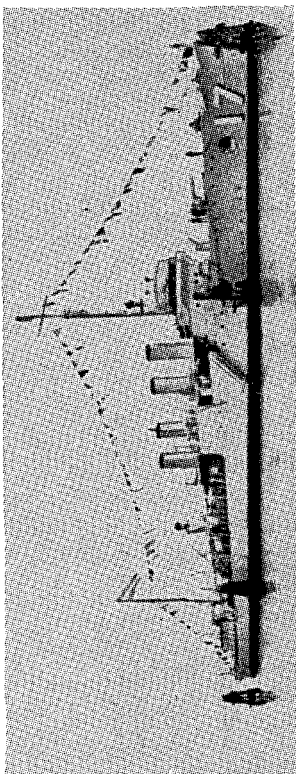

MONTGOMERY

IDENTIFICATION OF U. S. NAVAL VESSELS

Light mine layers

1 CLASS

GAMBLE	DM 15	TRACY	DM 19
RAMSAY	DM 16	PREBLE	DM 20
MONTGOMERY	DM 17	SICARD	DM 21
BREESE	DM 18	PRUITT	DM 22

Description: Displacement, 1,190 tons.
 Length, 310 feet (water line).
 Beam, $30\frac{2}{3}$ feet.
 Maximum draft, $13\frac{1}{2}$ feet.
 Speed, 35 knots.

Guns: 4 4-inch.
 1 3-inch AA.

Torpedo tubes: None.

Mines carried: 80

MILITARY INTELLIGENCE

UNITED STATES
NAVY

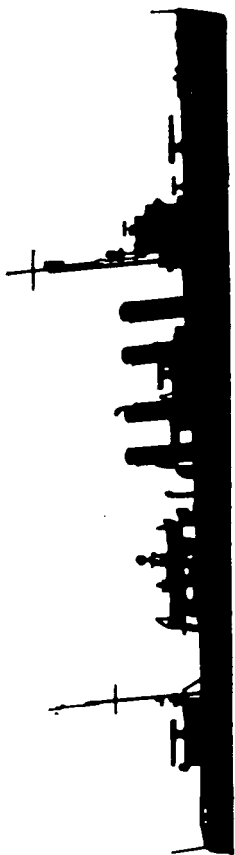

IDENTIFICATION OF U. S. NAVAL VESSELS

Light mine layers

SECTION VIII
SUBMARINES

MILITARY INTELLIGENCE

UNITED STATES
NAVY

GRAMPUS CLASS

GAR	206	GRAYLING	209
GRAMPUS	207	GRENADIER	210
GRAYBACK	208	GUDGEON	211

Description: Displacement, 1,475 tons.

Length, 299 feet.

Beam, 27 feet.

Draft, 14 feet.

Speed, 21 knots.

Guns: 1 3-inch AA.

2 machine guns AA.

Torpedo tubes: 10.

IDENTIFICATION OF U. S. NAVAL VESSELS

Submarines



THRESHER CLASS

TAMBOR	198	TRITON	201
TAUOG	199	TROUT	202
THRESHER	200	TUNA	203

Description: Displacement, 1,450 tons.
 Length, 300 feet (water line).
 Beam, 27 feet.
 Draft, 13¾ feet (mean).

Guns: 1 3-inch.
 1 machine gun AA.

Torpedo tubes: 10.

MILITARY INTELLIGENCE

UNITED STATES
NAVY

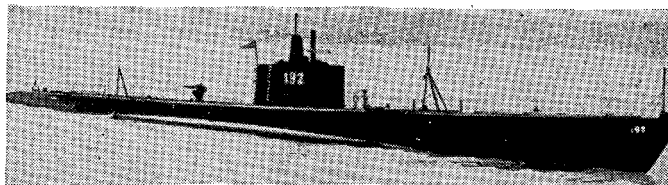

SAILFISH



SARGO CLASS

SARGO	188	SWORDFISH	193
SAURY	189	SEADRAGON	194
SPEARFISH	190	SEALION	195
SCULPIN	191	SEARAVEN	196
SAILFISH	192	SEAWOLF	197

Description: Displacement, 1,450 tons.
Length, 300 feet (water line).
Beam, 27 feet.
Draft, 13¾ feet (mean).

Guns: 1 3-inch.
1 machine gun AA.

Torpedo tubes: 8.

IDENTIFICATION OF U. S. NAVAL VESSELS

Submarines

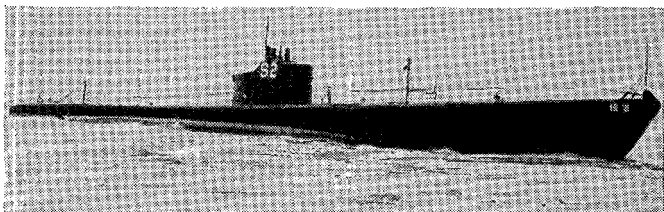

SEAL



SALMON CLASS

SALMON	182	SNAPPER	185
SEAL	183	STINGRAY	186
SKIPJACK	184	STURGEON	187

Description: Displacement, 1,450 tons.
 Length, 298 feet (water line).
 Beam, 26 feet.
 Draft, 14¼ feet (mean).

Guns: 1 3-inch.
 1 machine gun AA.

Torpedo tubes: 8.

MILITARY INTELLIGENCE

UNITED STATES
NAVY



PLUNGER



PERCH CLASS

PERCH	176	PLUNGER	179
PICKEREL	177	POLLACK	180
PERMIT	178	POMPANO	181

Description: Displacement, 1,330 tons.
Length, 290 feet (water line).
Beam, 25 feet.
Draft, 13 $\frac{5}{8}$ feet (mean).

Guns: 1 3-inch.
1 machine gun AA.

Torpedo tubes: 6.

IDENTIFICATION OF U. S. NAVAL VESSELS

Submarines

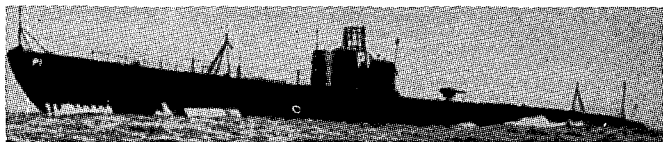

PORPOISE



PIKE CLASS

PORPOISE	172	SHARK	174
PIKE	173	TARPON	175

Description: Displacement, 1,315 tons.
 Length, 287 feet (water line).
 Beam, 25 feet.
 Draft, 13 $\frac{5}{6}$ feet (mean).
 Speed, 20 knots.

Guns: 1 3-inch.

Torpedo tubes: 6.

MILITARY INTELLIGENCE

UNITED STATES
NAVY

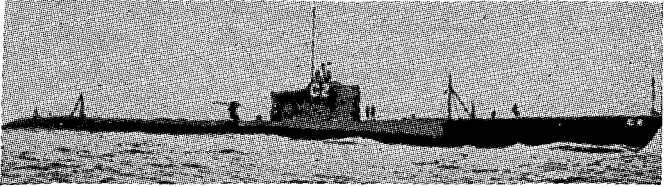

CUTTLEFISH



CUTTLEFISH CLASS

CACHALOT	170
CUTTLEFISH	171

Description: Displacement, 1,110 tons.
Length, 260 feet (water line).
Beam, 24 $\frac{3}{4}$ feet.
Draft, 12 $\frac{5}{8}$ feet.
Speed, 17 knots.

Guns: 1 3-inch AA.

Torpedo tubes: 6

IDENTIFICATION OF U. S. NAVAL VESSELS

Submarines

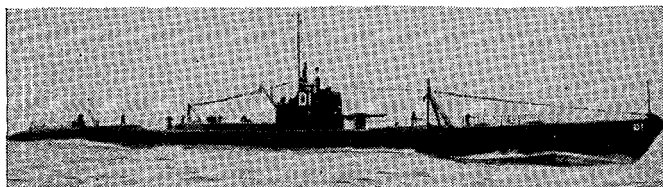

DOLPHIN



DOLPHIN CLASS

DOLPHIN	169
Description:	Displacement, 1,540 tons. Length, 307 feet (water line). Beam, 27 $\frac{5}{8}$ feet. Draft, 13 feet. Speed, 17 knots.
Guns:	1 4-inch.
Torpedo tubes:	6.

MILITARY INTELLIGENCE

UNITED STATES
NAVY

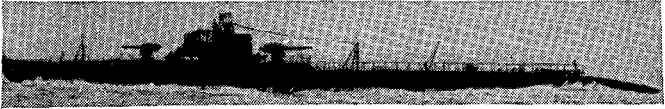

NAUTILUS



NAUTILUS CLASS

NARWHAL	167
NAUTILUS	168

Description: Displacement, 2,730 tons.
Length, 349 feet (water line).
Beam, $33\frac{1}{5}$ feet.
Draft, $15\frac{1}{3}$ feet.
Speed, 17 knots.

Guns: 2 6-inch.

Torpedo tubes: 6.

IDENTIFICATION OF U. S. NAVAL VESSELS

Submarine
Minelayers

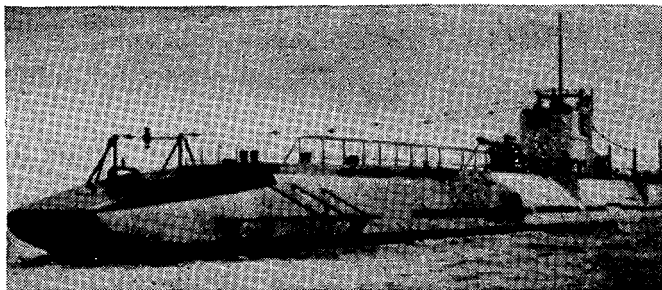

ARGONAUT



ARGONAUT CLASS

ARGONAUT 166

Description: Displacement, 2,710 tons.
Length, 358 feet (water line).
Beam, $33\frac{4}{5}$ feet.
Draft, $15\frac{1}{3}$ feet.
Speed, 13 knots.

Guns: 2 6-inch.
Torpedo tubes: 4.
Mines: 60.

MILITARY INTELLIGENCE

UNITED STATES
NAVY

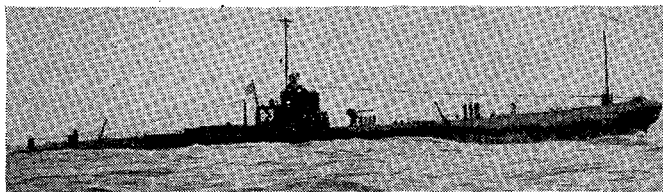

BONITA



BONITA CLASS

BARRACUDA 163
BASS 164
BONITA 165

Description: Displacement, 2,000 tons.
Length, 326 feet (water line).
Beam, $27\frac{1}{12}$ feet.
Draft, $14\frac{1}{2}$ feet.
Speed, $18\frac{3}{4}$ knots.

Guns: 1 3-inch AA.
2 machine guns.

Torpedo tubes: 6.

Torpedoes: 16.

IDENTIFICATION OF U. S. NAVAL VESSELS

Fleet
Submarines

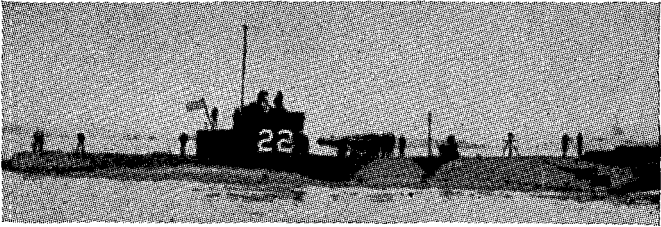

S-22



S-22 CLASS

S 1

S 18

S 20-48

Description: Displacement, 800 tons.
 Length, 219 $\frac{1}{4}$ feet.
 Beam, 20 $\frac{2}{3}$ feet.
 Draft, 15 feet.
 Speed, 14 $\frac{1}{2}$ knots.

Guns: 1 4-inch.

Torpedo tubes: 4.

Torpedoes: 12.

MILITARY INTELLIGENCE

UNITED STATES
NAVY

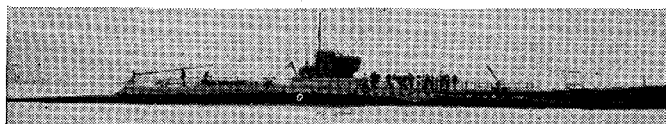

S-14

Fleet Submarines
S-14 CLASS

S 11-17

Description: Displacement, 790 tons.
Length, 231 feet.
Beam, 21⁵/₆ feet.
Draft, 13 feet.
Speed, 14 knots.

Guns: 1 4-inch.

Torpedo tubes: 4.

Torpedoes: 12.

IDENTIFICATION OF U. S. NAVAL VESSELS

Coastal
Submarines



MACKEREL CLASS

MACKEREL	204
MARLIN	205
Description:	Displacement, 800 tons. Length, 231 feet. Beam, 21½ feet. Draft, 12 feet. Speed, 14½ knots.
Guns:	1 3-inch. 2 machine guns.
Torpedo tubes:	6

MILITARY INTELLIGENCE

UNITED STATES
NAVY

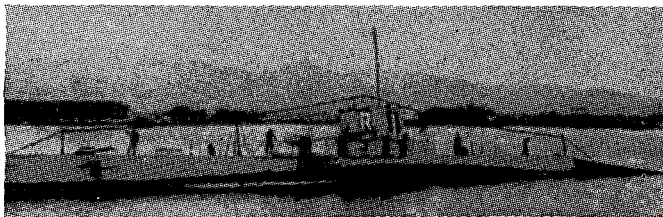

R-1



R CLASS

R 1-7

R 9-20

Description: Displacement, 530 tons.
Length, 186 feet.
Beam, 18 feet.
Draft, 14½ feet.

Guns: 1 3-inch.
Torpedo tubes: 4.
Torpedoes: 8.

IDENTIFICATION OF U. S. NAVAL VESSELS

Coastal
Submarines

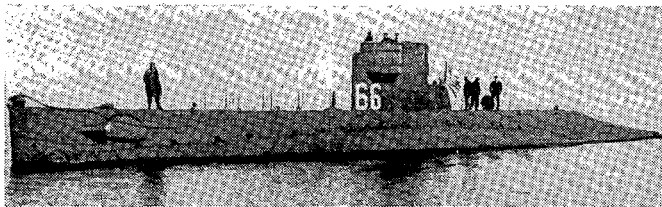

O-6

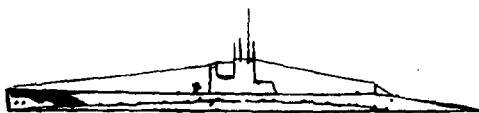

O CLASS

O-2

O-4

O-6-10

Description: Displacement, 480 tons.
Length, $172\frac{1}{3}$ feet.
Beam, 18 feet.
Draft, $14\frac{1}{2}$ feet.
Speed, $14\frac{1}{2}$ knots.

Guns: 1 3-inch AA.

Torpedo tubes: 4.

Torpedoes: 8.

SECTION IX
TORPEDO BOATS, GUN BOATS, TENDERS, ETC.

MILITARY INTELLIGENCE

UNITED STATES
NAVY



PT 3

IDENTIFICATION OF U. S. NAVAL VESSELS

Torpedo Boats

CLASS 1

PT 1

PT 2

PT 3

PT 4

Description: Displacement, 20 tons.

Length, 59 feet.

Beam, —.

Draft, —.

Speed, 40 knots.

Guns:

Torpedo tubes:

MILITARY INTELLIGENCE

UNITED STATES
NAVY

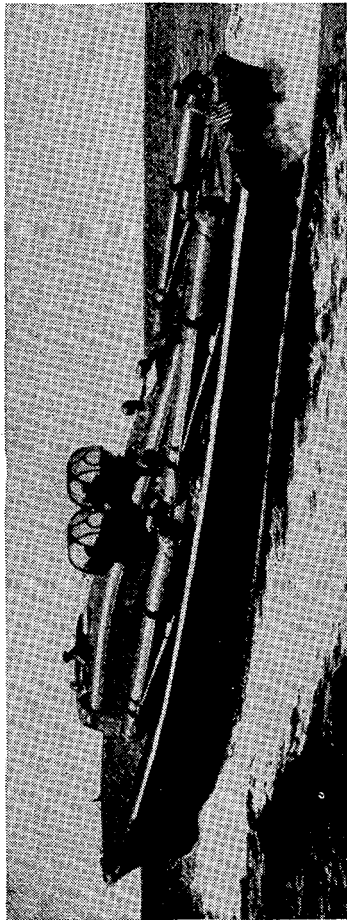

CLASS 2

PT 5-32

Description: Displacement, 35 tons.
Length, 81 feet.
Beam, —.
Draft, —.
Speed, 40 knots.
Guns: 2 25-mm.
Torpedo tubes:

MILITARY INTELLIGENCE

UNITED STATES
NAVY

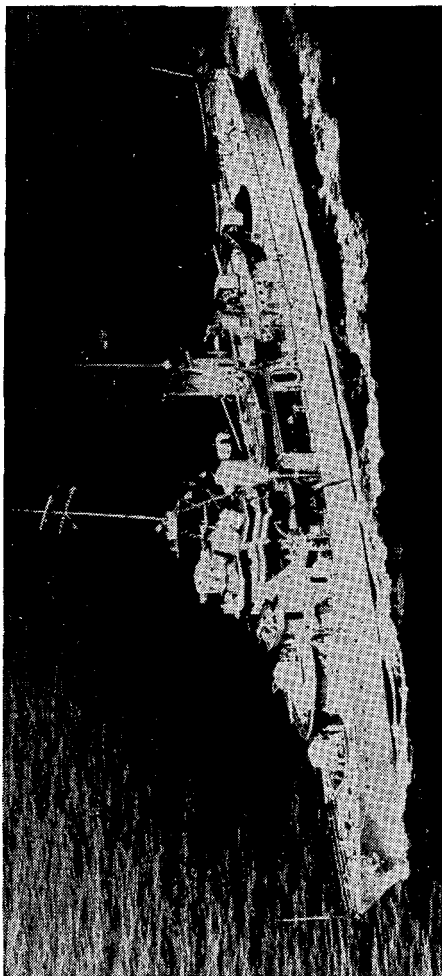

CHARLESTON

IDENTIFICATION OF U. S. NAVAL VESSELS

Gunboats
ERIE CLASS

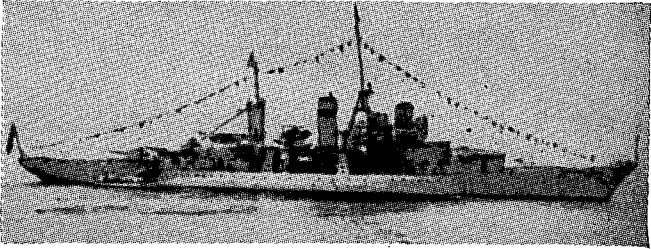

ERIE



ERIE CLASS

CHARLESTON
ERIE

Description: Displacement, 2,000 tons.
Length, 308 feet (water line).
Beam, 41 $\frac{1}{3}$ feet.
Draft, 11 $\frac{1}{2}$ feet (mean).
Speed, 20 knots.

Guns: 4 6-inch.
2 machine guns AA.
2 3-pounders.

Airplanes: 1.

MILITARY INTELLIGENCE

UNITED STATES
NAVY

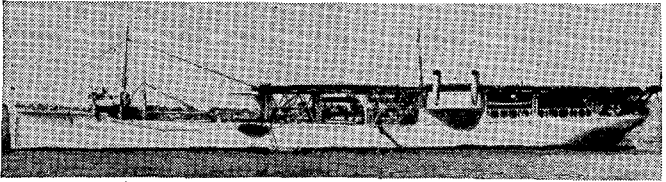

LANGLEY



AIRCRAFT TENDER

LANGLEY

Description: Displacement, 11,050 tons.
Length, 519 feet (water line).
Beam, 65½ feet.
Maximum draft, 24 feet.
Speed, 15 knots.

Guns: 4 5-inch.
Airplanes: 2.

IDENTIFICATION OF U. S. NAVAL VESSELS

Aircraft tenders

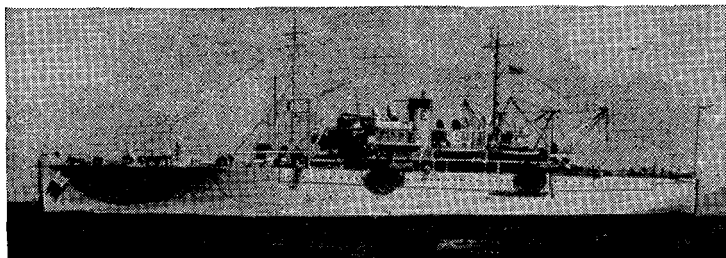

WRIGHT



AIRCRAFT TENDER

WRIGHT

Description: Displacement, 8,675 tons.
Length, 448 feet.
Beam, 58 feet.
Maximum draft, $27\frac{5}{8}$ feet.
Speed, 15 knots.

Guns: 2 5-inch.
2 3-inch AA.
4 machine guns AA.

MILITARY INTELLIGENCE

UNITED STATES
NAVY

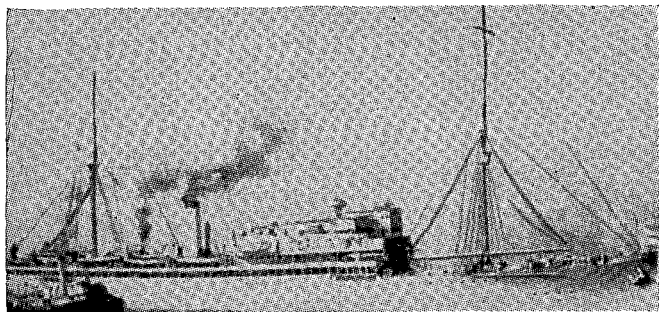

WHITNEY



DESTROYER TENDERS

WHITNEY
DOBBIN

Description: Displacement, 8,325 tons.
Length, 460 feet.
Beam, 61 feet.
Draft, $24\frac{1}{8}$ feet (mean).
Speed, 16 knots.

Guns: 8 5-inch.
4 3-inch AA.
2 6-pounders.

Torpedo tubes: 2.

IDENTIFICATION OF U. S. NAVAL VESSELS

Destroyer tenders

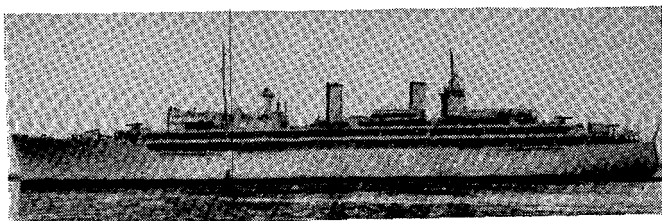

DIXIE

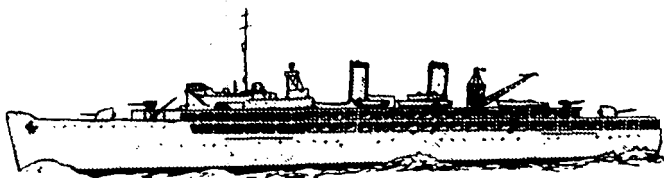

DIXIE, PRAIRIE

DESTROYER TENDERS

DIXIE
PRAIRIE

Description: Displacement, 9,450 tons.
Length, 520 feet (water line).
Beam, 73½ feet.
Draft, —.
Speed, —.

MILITARY INTELLIGENCE

UNITED STATES
NAVY

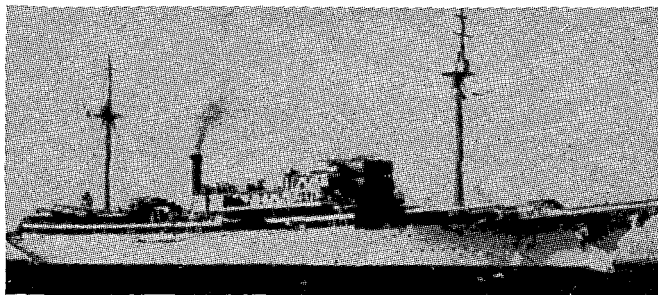

HOLLAND

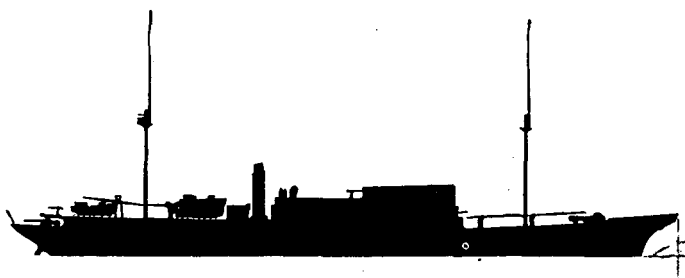

SUBMARINE TENDER

HOLLAND

Description: Displacement, 8,100 tons.

Length, 360 feet.

Beam, 61 feet.

Draft, $22\frac{3}{4}$ feet (mean).

Speed, 16 knots.

Guns: 8 5-inch.

4 3-inch AA.

2 6-pounders.

Torpedo tubes: 1.

IDENTIFICATION OF U. S. NAVAL VESSELS

Training ship

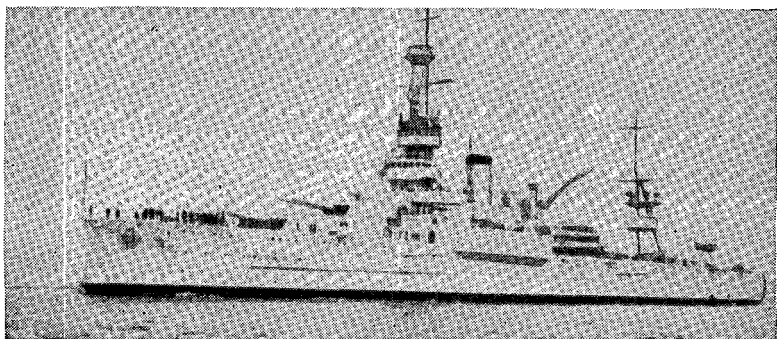

WYOMING

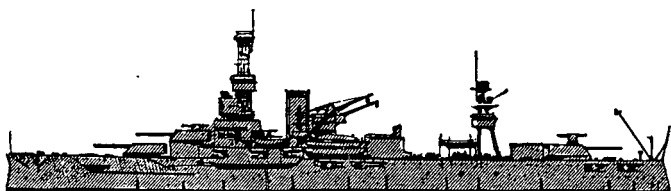

WYOMING

TRAINING SHIP

WYOMING

Description: Displacement, 19,700 tons.
Length, 555½ feet (water line).
Beam, 93 feet.
Draft, 23½ feet (mean).
Speed, 18 knots.

Guns:
6 12-inch.
16 5-inch.
8 3-inch AA.
4 6-pounders.

