

RESTRICTED

FOR OFFICIAL USE ONLY

AN 01-60GE-1

*PILOT'S FLIGHT OPERATING
INSTRUCTIONS*

FOR

AIRPLANES

ARMY MODELS

B-25J-1, -5, -10, -15, -20, -25, -30, -35

NAVY MODEL

PBJ-1J

BRITISH MODEL

MITCHELL III

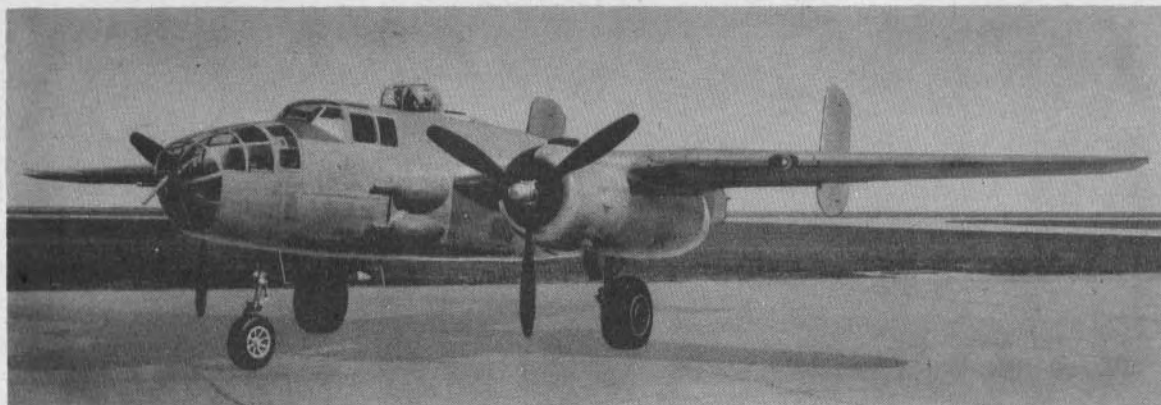

This publication contains specific instructions for pilots and should be available for Transition Flying Training as contemplated in AAF Reg. 50-16.

Appendix I of this publication shall not be carried in aircraft on combat missions or when there is a reasonable chance of its falling into the hands of the enemy.

Published under joint authority of the Commanding General, Army Air Forces, the Chief of the Bureau of Aeronautics, and the Air Council of the United Kingdom.

NOTICE: This document contains information affecting the national defense of the United States within the meaning of the Espionage Act, 50 U. S. C., 31 and 32, as amended. Its transmission or the revelation of its contents in any manner to an unauthorized person is prohibited by law.

RESTRICTED

POLICY GOVERNING DISTRIBUTION AND USE OF THIS PUBLICATION

Instructions Applicable to U. S. Army Personnel:

1. This publication is intended for technical aid and education of military and civilian personnel engaged in promoting the war effort. Its maximum distribution and use is therefore encouraged. However, since the publication is "restricted" within the meaning of AR380-5, the following security regulations will be observed:

a. *Members of Armed Forces and civilian employees of War Department* will be given access to this publication whenever required to assist in the performance of their official duties (including expansion of their knowledge of AAF equipment, procedures, etc.).

b. *Personnel of War Department contractors and subcontractors* may be given possession of this publication, on a loan basis, or knowledge of its contents, only when required to assist in the performance of War Department contracts. Releases will be made in accordance with the requirements of T. O. No. 00-5-2.

c. *Representatives of other governments* will be given possession of this publication, or knowledge of its contents, only in accordance with AAF Letter No. 45-6.

2. This publication is restricted because the information contained in it is restricted. It does not follow that the physical article to which it relates is also restricted. Classification of the materiel or component must be ascertained independently of the classification of this document.

3. Neither this publication nor information contained herein will be communicated to press or public except through Public Relations channels.

Instructions Applicable to U. S. Navy Personnel:

1. Navy Regulations, Article 76, contains the following statements relating to the handling of restricted matter:

"Par. (9) (a). Restricted matter may be disclosed to persons of the Military or Naval Establishments in accordance with special instructions issued by the originator or other competent authority, or in the absence of special instructions, as determined by the local administrative head charged with custody of the subject matter."

"(b) Restricted matter may be disclosed to persons of discretion in the Government service when it appears to be in the public interest."

"(c) Restricted matter may be disclosed, under special circumstances, to persons not in the Government service when it appears to be in the public interest."

2. The Bureau of Aeronautics Aviation Circular Letter No. 90-44 contains the following paragraph relative to the use of aeronautical technical publications:

"Par. 8. *Distribution to All Interested Personnel.* In connection with the distribution of aeronautical publications within any activity, it should be borne in mind by the offices responsible for such distribution that technical publications, whether confidential or restricted, are issued for use not only by officer personnel, but also by responsible civilian and enlisted personnel working with or servicing equipment to which the information applies."

3. Disclosure of technical information in this publication may not be made to representatives of foreign governments except in instances where those foreign governments have been cleared to receive information concerning all equipments covered by this publication.

Instructions Applicable to British Personnel:

FOR OFFICIAL USE ONLY.—Not to be communicated to anyone outside of His Majesty's Service. Not to be published. The information given in this document is not to be communicated, either directly or indirectly, to the press or to any person not holding an official position in His Majesty's Service.

LIST OF REVISED PAGES ISSUED

NOTE: A heavy black vertical line to the left or in outer margin of text on revised pages, indicates extent of revision. This line is omitted where more than 50 percent of page is revised. A black horizontal line to the left of page numbers listed below indicates pages revised, added or deleted by current revision. This line is used only on second and subsequent revisions.

Page No.	Date of Latest Revision	Page No.	Date of Latest Revision	Page No.	Date of Latest Revision
-i	15 July 1945	38	5 February 1945	78	25 March 1945
1	10 October 1944	39	15 November 1944	78A	25 March 1945
5	25 December 1944	46	5 February 1945	79	25 December 1944
7	25 December 1944	46A	5 February 1945	80	25 December 1944
8	25 December 1944	47	25 March 1945	81	25 December 1944
10	25 December 1944	48	10 October 1944	85	5 February 1945
18	10 October 1944	48A	10 October 1944	86	5 February 1945
18A	10 October 1944	48B	10 October 1944	87	5 February 1945
18B	25 December 1944	-52	15 July 1945	88	5 February 1945
-19	15 July 1945	55	10 October 1944	89	5 February 1945
-21	15 July 1945	-56A	15 July 1945	90	5 February 1945
-22	15 July 1945	-56B	15 July 1945	91	5 February 1945
27	25 December 1944	-56C	15 July 1945	92	5 February 1945
-28	15 July 1945	-57	15 July 1945	93	5 February 1945
29	25 December 1944	58	25 March 1945	94	5 February 1945
30	15 November 1944	59	10 October 1944	95	5 February 1945
32	15 November 1944	60	10 October 1944	96	5 February 1945
-32A	15 July 1945	-60A	15 July 1945	96A	5 February 1945
33	25 March 1945	62	25 December 1944	96B	5 February 1945
34	25 March 1945	-63	15 July 1945	96C	5 February 1945
35	25 May 1945	66	25 March 1945	96D	5 February 1945
36	25 May 1945	68	25 March 1945	96E	5 February 1945
36A	25 May 1945	70	10 October 1944	96F	5 February 1945
36B	25 May 1945	71	10 October 1944		
36C	25 May 1945	-77	15 July 1945		

AAF

ADDITIONAL COPIES OF THIS PUBLICATION MAY BE OBTAINED AS FOLLOWS:

AAF ACTIVITIES.—In accordance with T. O. No. 00-5-2, Air Inspectors will submit requisitions (AAF Form 104B) to:

Commanding General
Fairfield Air Technical Service Command
Patterson Field, Ohio
Attn: Publications Distribution Branch

NAVY ACTIVITIES.—Submit requests to Chief, BuAer, Navy Department, Washington, D. C., Attention: Publications Branch on order form NAVAER-140. For complete listing of available material and details of distribution see Naval Aeronautic Publications Index, NavAer 00-500.

BRITISH ACTIVITIES.—Submit requirements on Form 294A, in duplicate, to the Air Publications and Forms Store, New College, Leadhall Lane, Harrogate, Yorkshire, England.

TABLE OF CONTENTS

	PAGE		PAGE
SECTION I Description		SECTION III Flight Operating Data	
1. General	1	1. Specific Engine Flight Chart.....	35
2. Duties of Crew Members.....	1	2. Airspeed Correction Chart.....	35
3. Flight Controls	1	3. Load and Balance.....	35
4. Landing Gear.....	1	SECTION IV Emergency Operating Instructions	
5. Wheels and Brakes.....	7	1. General	37
6. Hydraulics	7	2. Emergency Exits on Ground.....	37
7. Power Plant.....	7	3. Engine Failure During Flight.....	37
8. Fuel System	14	4. Emergency Exits During Flight.....	39
9. Oil System	14	5. Ditching	39
10. Heating and Ventilating System.....	18	6. Landing Gear Emergency Lowering System	46A
11. Electrical System	18	7. Wing Flap Emergency Lowering Equipment	47
12. Miscellaneous Equipment.....	18	8. Emergency Brake Operation.....	48
SECTION II Pilot's Operating Instructions		9. Gun Turret Emergency Operation.....	50
1. Flight Restrictions	19	10. Bomb or Droppable Fuel Tank Emergency Release	50
2. Before Entering Pilot's Compartment.....	19	11. Bomb Bay Door Emergency Operation....	50
3. On Entering Pilot's Compartment.....	21	12. Torpedo Emergency Release.....	52
4. Fuel System Management.....	22	13. Miscellaneous Emergency Equipment.....	52
5. Starting Engines.....	26	SECTION V Operational Equipment	
6. Engine Warm-up	28	1. Pilot	53
7. Emergency Take-off	28	2. Bombardier	63
8. Engine and Accessories Ground Test.....	28	3. Copilot-Navigator	66
9. Taxiing	28	4. Upper Turret Gunner.....	68
10. Before Take-off	29	5. Waist Gunner	71
11. Take-off	29	6. Tail Turret Gunner.....	77
12. Engine Failure During Take-off.....	30	7. Oxygen System	78A
13. Climb	32	8. Miscellaneous Equipment	80
14. During Flight	32	APPENDIX I Glossary and Conversion Tables	
15. Engine Failure During Flight.....	32A	1. Glossary	83
16. General Flying Characteristics.....	32A	APPENDIX II Flight Operating Charts	
17. Stalls	32A	1. Flight Planning	85
18. Spins	32A		
19. Diving	32A		
20. Night Flying	32A		
21. Approaching and Landing.....	33		
22. Stopping Engines	34		
23. Before Leaving Pilot's Compartment.....	34		

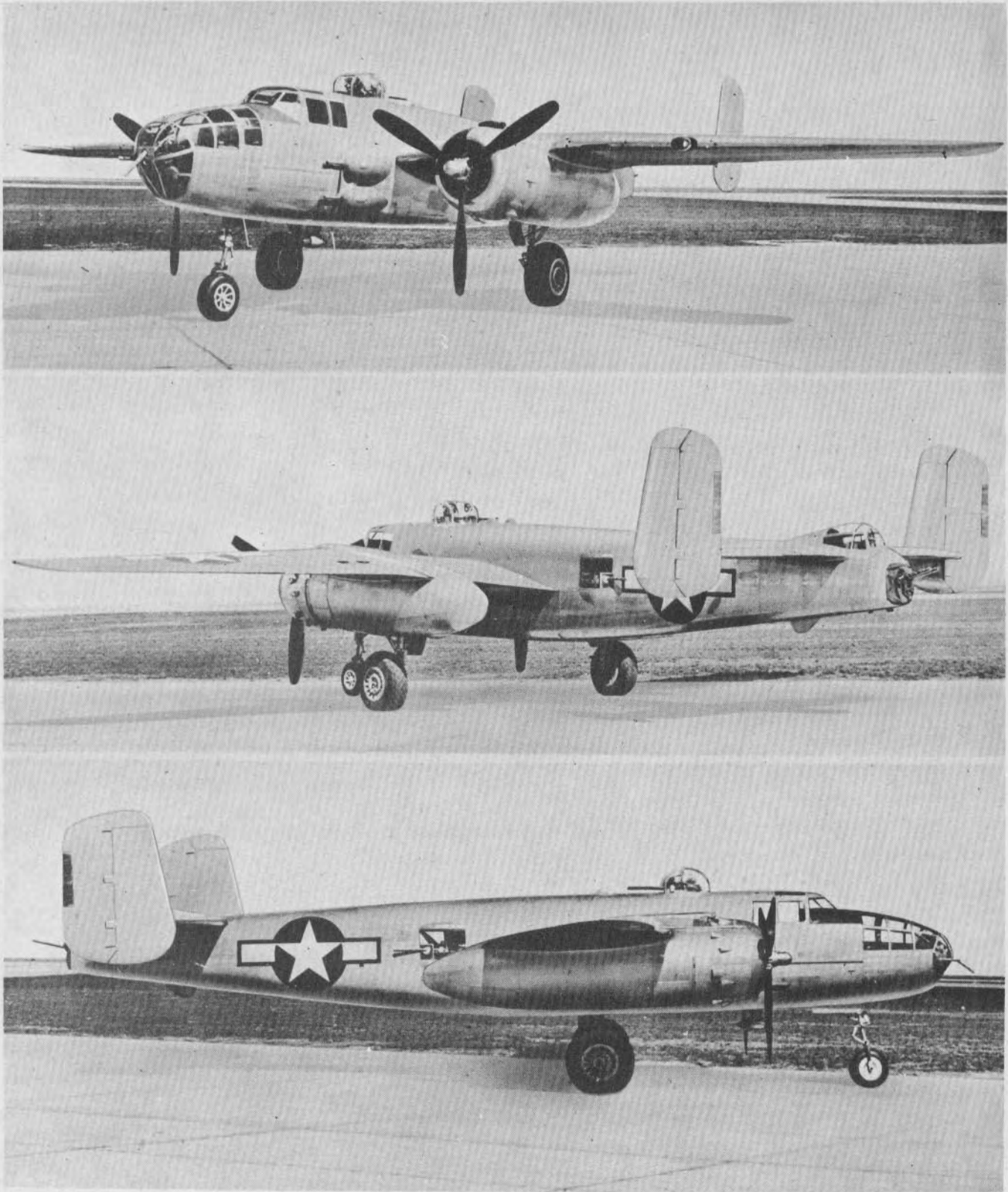
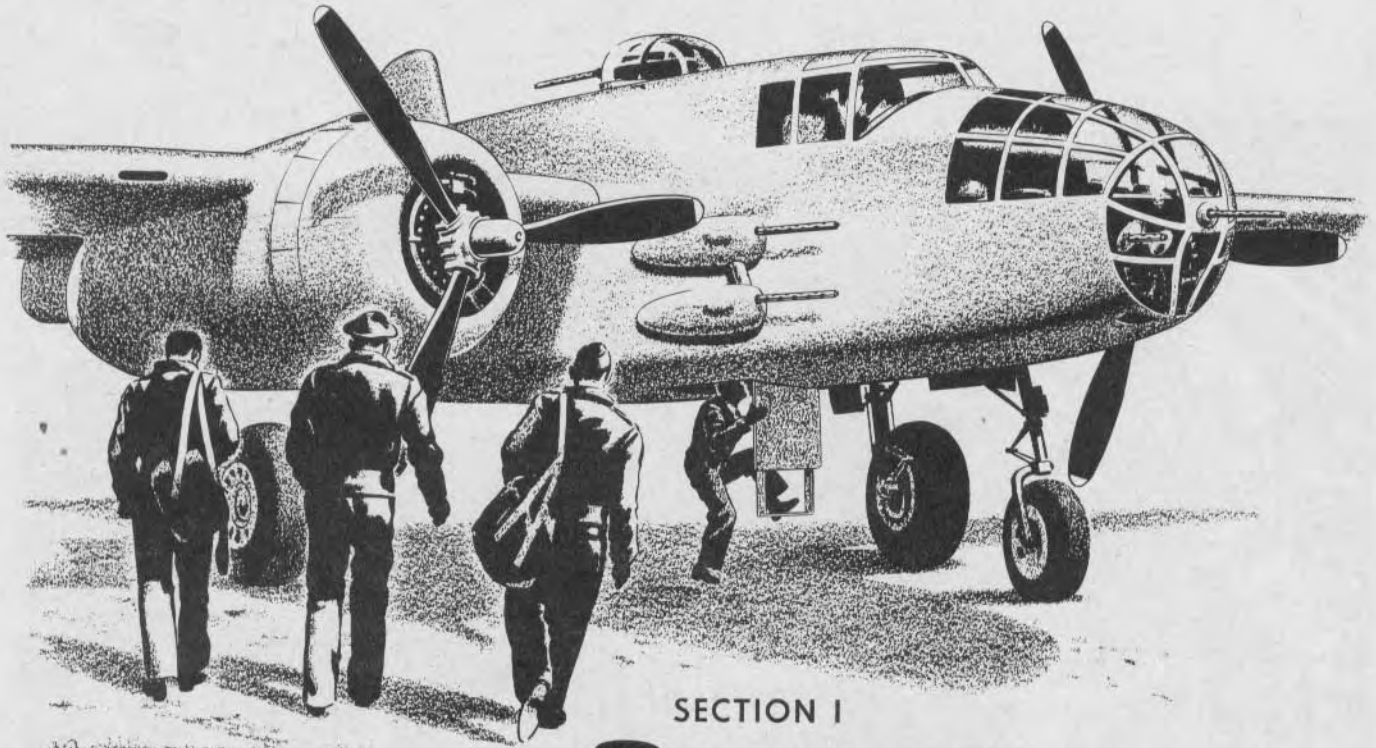

Figure 1—Three Views of Airplane



SECTION I
DESCRIPTION

1. GENERAL.

The North American B-25J Medium Bombardment Airplane is a midwing land monoplane powered by two Wright Cyclone R-2600-13 or -29 engines. It has a wing span of 67 feet 7 inches, a length of 53 feet $5\frac{3}{4}$ inches (not including armament) and a height of 16 feet $4\frac{3}{16}$ inches. Characteristic features are a tricycle landing gear and a double fin and rudder empennage. The airplane is armed with twelve (thirteen on late airplanes) .50-caliber machine guns and is equipped to carry bombs or depth charges. Provisions may be made for carrying a torpedo. (See figure 5 for armor plate protection.)

2. DUTIES OF CREW MEMBERS.

In addition to flying the airplane, the pilot fires the fixed nose gun and the four blister guns, and operates the command and identification radio equipment. The pilot may also release the bombs. The copilot aids the pilot and navigates the airplane. The bombardier releases the bombs and fires the flexible nose gun. The upper turret gunner is also flight engineer. The waist gunner operates both waist guns, the liaison radio, and the photographic equipment. The tail gunner operates the rear turret. See figure 6 for fuselage arrangement.

3. FLIGHT CONTROLS.

The rudders, elevators, and ailerons are controlled by duplicate cable systems, so that the loss of any one control cable will not seriously cripple the airplane. The rudders and ailerons are equipped with combination booster and controllable trim tabs. The elevators have controllable trim tabs which are set for no boost. A bungee installed in the elevator control system reduces stick loads. A locking system affecting all of the control surfaces simultaneously is controlled by a handle on the floor in front of the pilot's control column.

4. LANDING GEAR.

a. GENERAL.—The landing gear is hydraulically operated. The main gear retracts into the engine nacelles, and the nose gear into the fuselage. Doors cover the gear openings in both the retracted and extended positions.

b. NOSE GEAR.—The swivel-type nose gear strut incorporates a centering device which operates when the strut is fully extended (wheel off ground). A hydraulic shimmy damper on the strut resists side loads occurring in taxiing, take-off, and landing, thus preventing a sudden movement

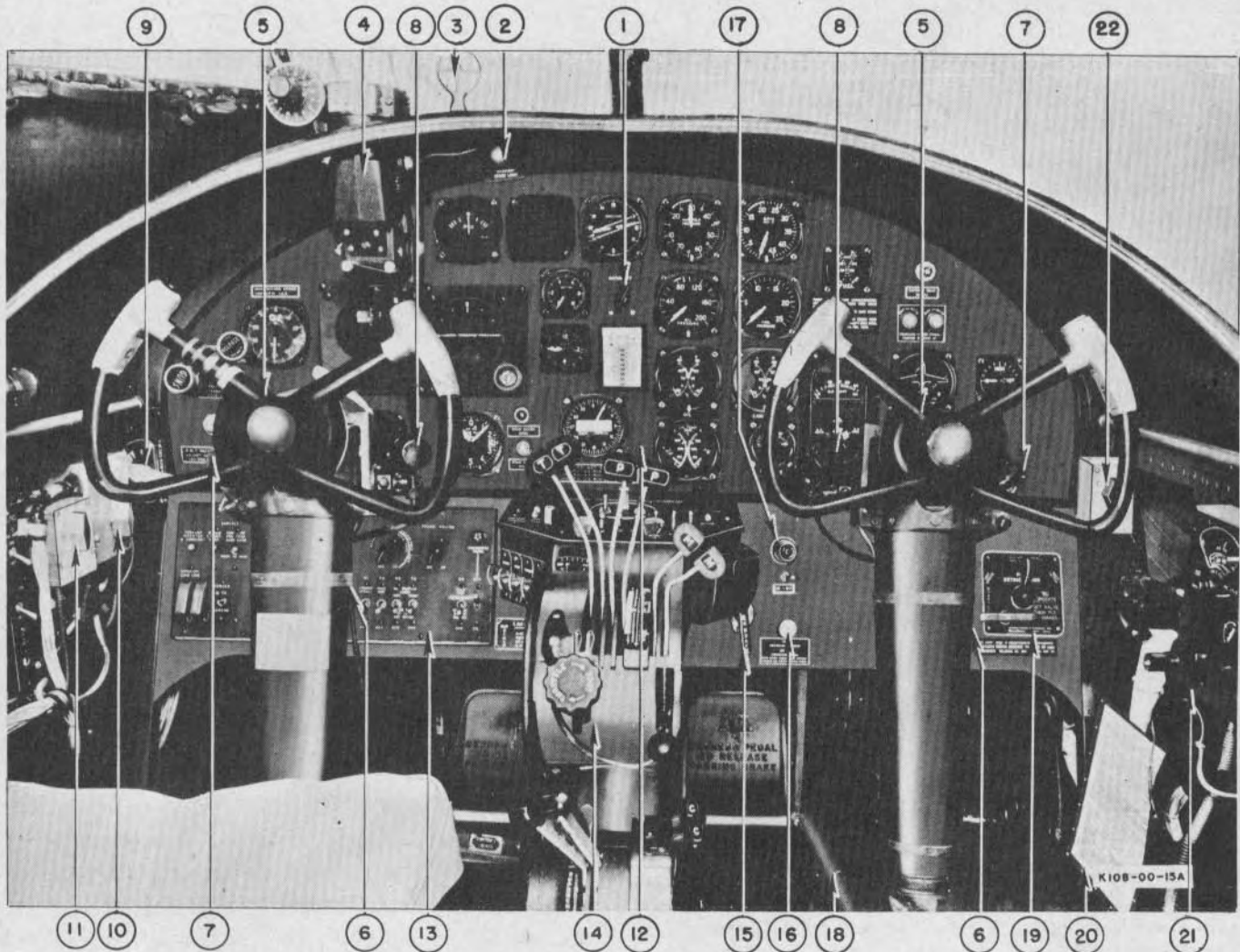

- | | |
|------------------------------|---------------------------------------|
| 1. Gun Sight Rheostat | 12. Instrument Panel |
| 2. Gun Sight Spare Lamp | 13. Pilot's Switch Panel |
| 3. Ring Sight | 14. Engine Control Pedestal |
| 4. Gun Sight | 15. Parking Brake Handle |
| 5. Aileron Control Wheel | 16. Defroster Selector Control |
| 6. Control Column | 17. Extension Light |
| 7. Fluorescent Light Control | 18. Defroster Tube |
| 8. Fluorescent Light | 19. Engine Fire Extinguisher Controls |
| 9. Surface De-icer Control | 20. Pilot's Check List |
| 10. Interphone Jack Box | 21. Radio Compass Control Box |
| 11. Filter Switch Box | 22. Filter Switch Box |

Figure 2—Pilot's Compartment—Forward View

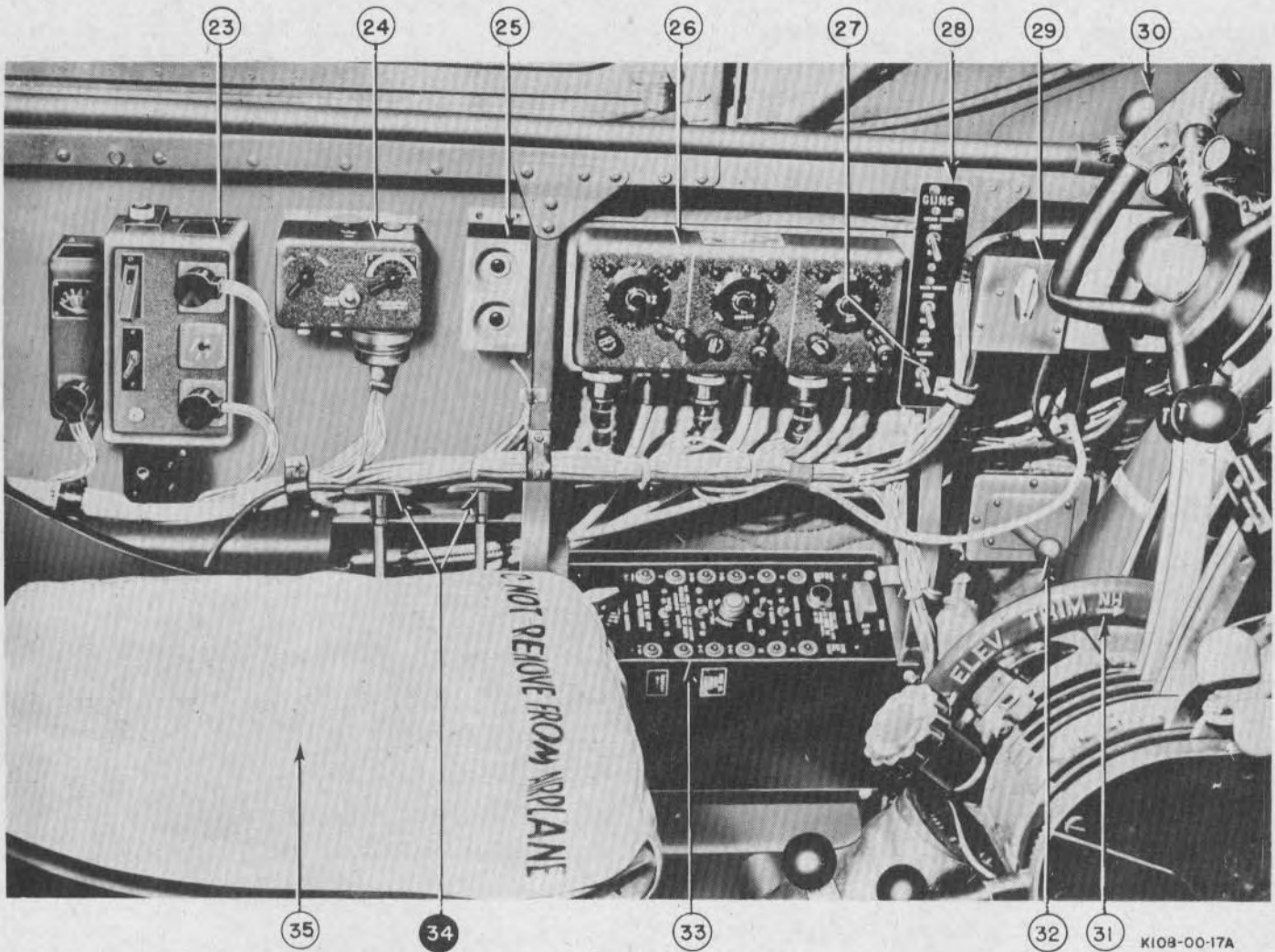

- | | |
|---------------------------------------|--|
| 23. SCR-595 or SCR-695 Control Box | 30. Sliding Window Handle |
| 24. Command Radio Transmitter Control | 31. Elevator Trim Tab Control Wheel |
| 25. Radio Demolition Switches | 32. Ventilator |
| 26. Command Radio Receiver Controls | 33. Bomb Control Panel |
| 27. Camera Selector Switch | 34. Emergency Fuel Shut-off Valve Controls |
| 28. Gun Control Switch Panel | 35. Cushion |
| 29. Filter Switch Box | |

Figure 3—Pilot's Compartment—Left Side

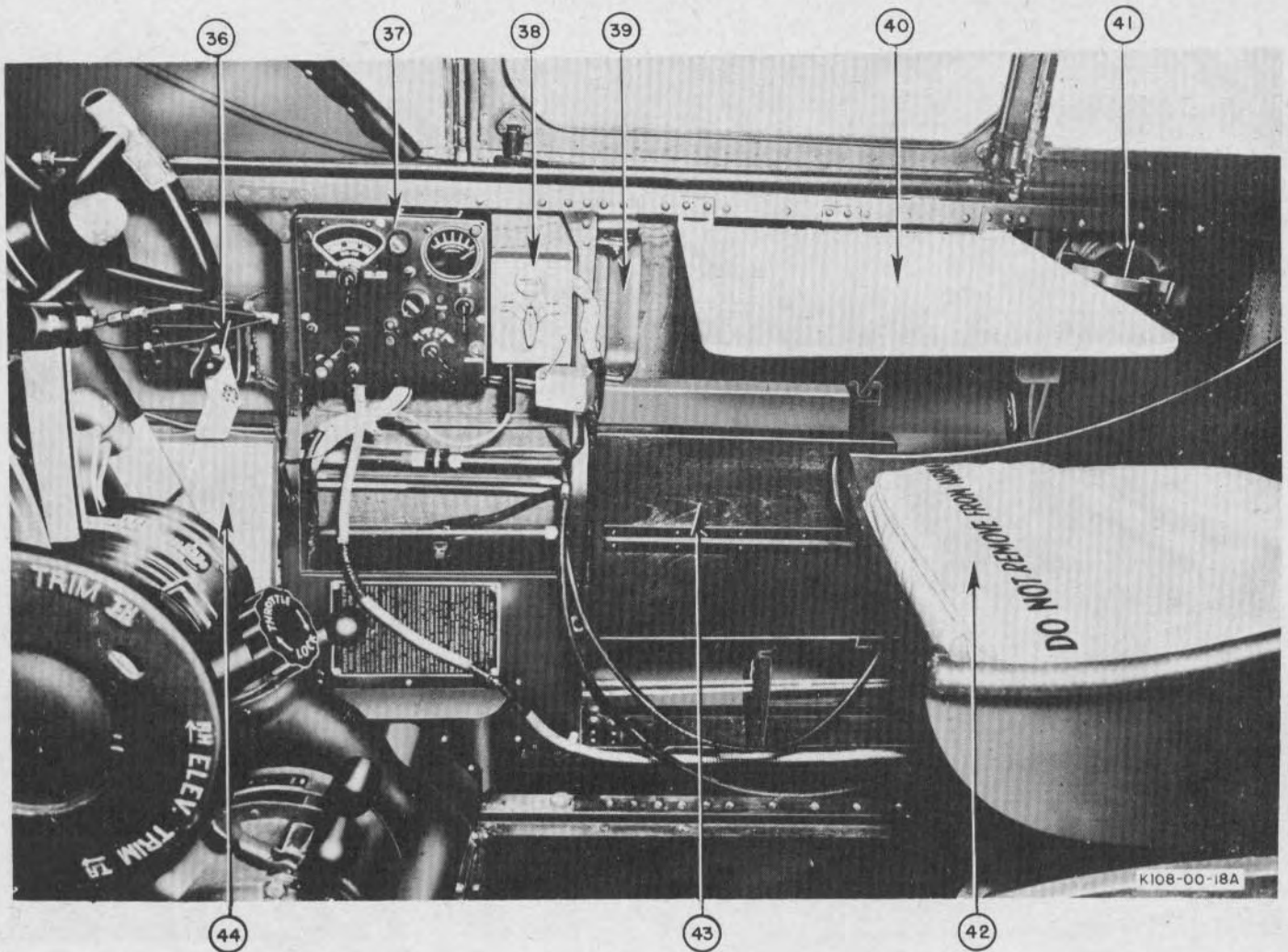

- | | |
|---------------------------------|------------------------|
| 36. Ventilator | 41. Driftmeter Port |
| 37. Radio Compass Control Box | 42. Cushion |
| 38. Interphone Jack Box | 43. Map Case |
| 39. Bomb Interval Control Mount | 44. Pilot's Check List |
| 40. Folding Table | |

Figure 4—Pilot's Compartment—Right Side

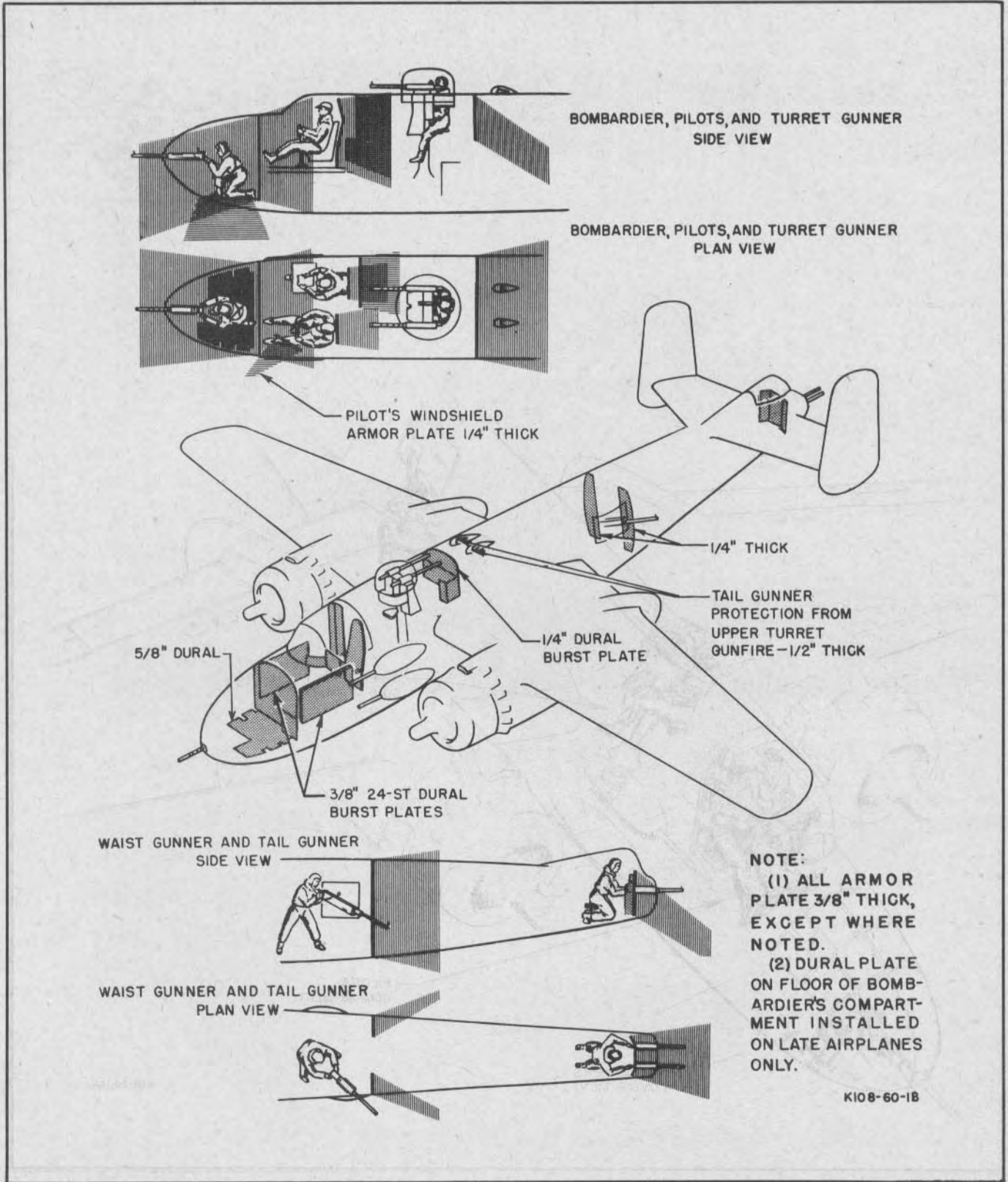

Figure 5—Armor Protection

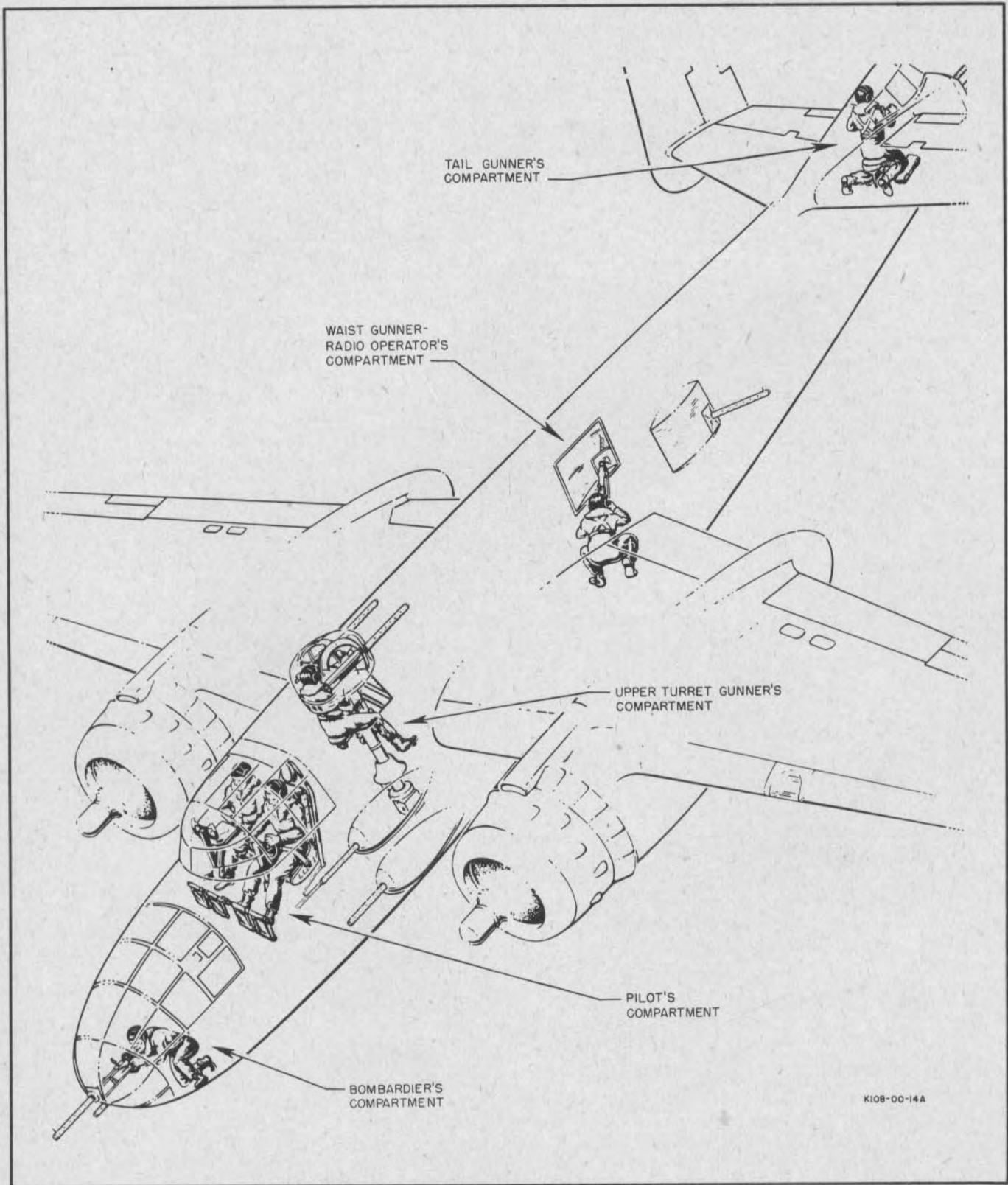

Figure 6—Fuselage Arrangement

of the wheel. The nose wheel may be released from the shimmy damper for towing purposes.

5. WHEELS AND BRAKES.

The wheels are of the smooth-contour type. The nose wheel tire is equipped with a dual-seal inner tube for protection against a blowout or puncture, and on late airplanes, a channel tread tire is mounted on the nose wheel. The main wheels are equipped with dual multiple-disc hydraulic brakes. On early airplanes, an air brake system is provided for use in the event of a complete hydraulic failure. Late airplanes are equipped with an emergency hydraulic brake system.

6. HYDRAULICS.

a. NORMAL.—A single high-pressure hydraulic system operates the tricycle landing gear, wing flaps, engine cowl flaps, bomb bay doors, and brakes. On late airplanes, the carburetor air induction system is hydraulically operated. If one of the engine-driven hydraulic pumps fails, the other will provide sufficient pressure for the operation of the hydraulic system.

b. EMERGENCY.—An emergency hydraulic system permits operation of the system even though both engine-driven pumps fail, or with the airplane on the ground and the engines inoperative. The hand-pump and selector valve are at the right of the pilot's seat. A separate hydraulic system provides for the emergency lowering of the landing gear in the event of complete failure of the general system, with loss of fluid. Emergency mechanical systems are provided for the operation of the wing flaps and bomb bay doors. A small reserve of fluid is retained under pressure in the accumulator for use if the engine pumps fail. This reserve is not adequate for completely raising or lowering the landing gear, but is sufficient for a one-way operation of the wing flaps, engine cowl flaps, or the bomb bay doors. The brake accumulator retains sufficient pressure for approximately three brake pedal applications (both wheels) even though both engine pumps should fail.

7. POWER PLANT.

a. ENGINES.—The airplane is powered by two Wright R-2600-13 or R-2600-29, air-cooled, 14-cylinder engines. Low gear supercharger ratio is 7.06:1 and high gear ratio is 10.06:1. The propeller gear ratio is 16:9. Engine equipment includes a Holley carburetor incorporating an electric primer valve. Individual flame-damping exhaust stacks reduce glare during night flying.

b. FUEL AND OIL.

Fuel	Spec. No. AN-F-28, Grade 100/130
Oil	Spec. No. AN-VV-O-446a, Grade 1120

Note

Under certain conditions when the airplane is within the continental United States, Spec. No. AN-F-26, Grade 91 fuel should be used.

c. CARBURETOR HEAT.—On early airplanes, warm air from around the cylinder heads is utilized for carburetor heat. On late airplanes, the exhaust from cylinders No. 3 and No. 13 may be introduced into the induction system. The carburetor air controls on all airplanes have two positions, "NORMAL" and "ICING." On late airplanes, it is necessary to move the controls back to neutral after the desired amount of heat rise is obtained. There is a power loss of approximately ten per cent when the engines are run at full power with the exhaust scoops in the full open position, due to the induction of exhaust gases. Each air scoop is equipped with a filter which may be replaced with a baffle when necessary.

Note

Unfortunately, the impression exists among some mechanics and pilots that the carburetor air filter causes a serious loss in airplane performance. The effect of installing a filter is merely equivalent to closing the throttle slightly. This means that for all altitudes less than critical, where manifold pressure limits prevent full throttle opening, the filter has no effect on engine power output or airplane performance. Manifold pressure affords the best indication of engine power, and at a given manifold pressure the engine will develop the same power regardless of whether or not a filter is installed. The only time that airplane performance would benefit from removal of the filter is when the throttle is fully open and still more manifold pressure would be permissible. With the filter installed, only cold ram air passes through the filter element.

d. PROPELLER.—The Hamilton Standard Hydromatic full-feathering constant speed propellers have a blade diameter of 12 feet 7 inches and are controlled by double-capacity governors which are set by means of levers on the pilot's control pedestal. The electrically driven feathering pumps are controlled by two push buttons on the control pedestal switch panel. Propeller pitch settings are 22° low and 90° high.

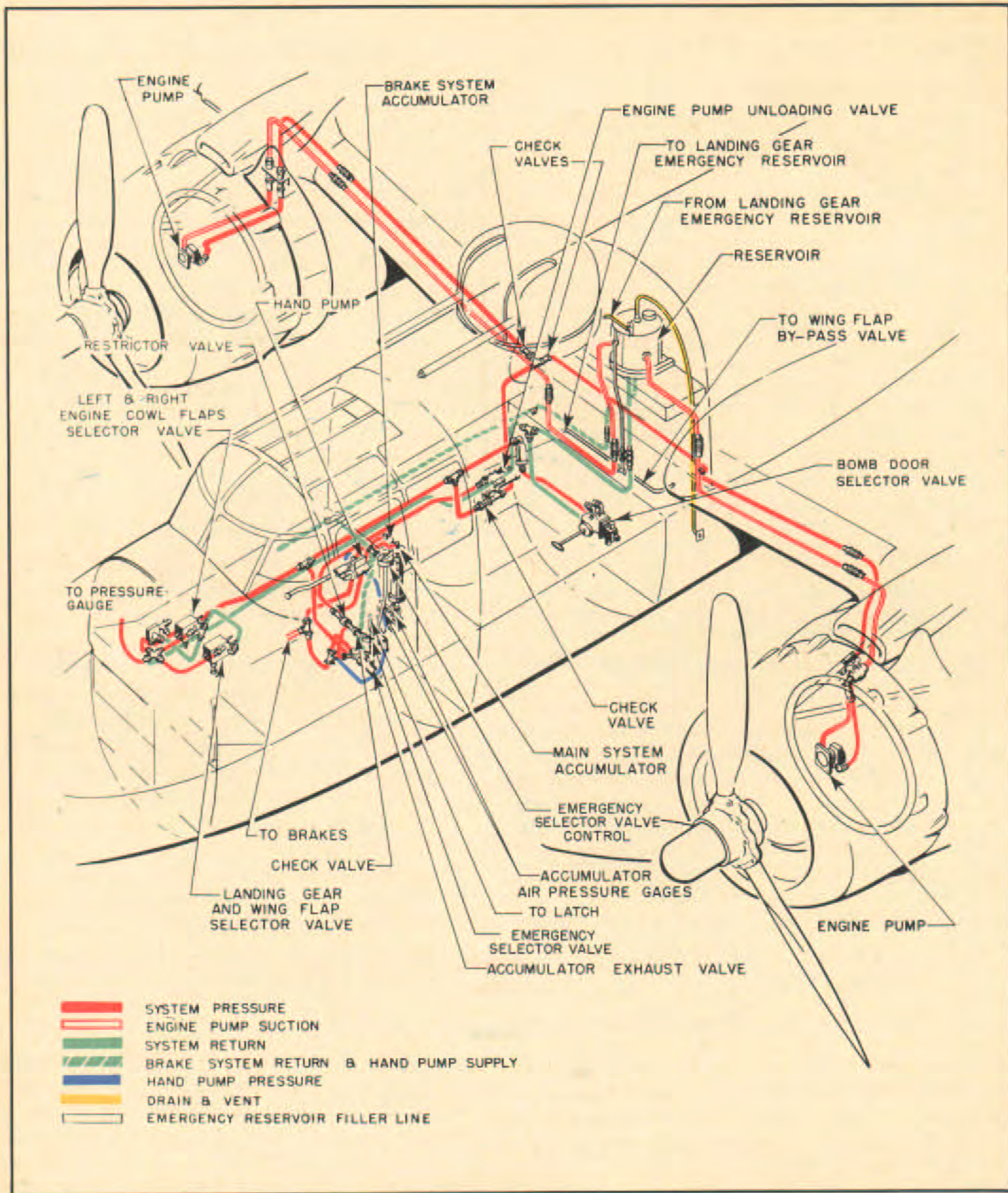

Figure 7—Hydraulic Power System

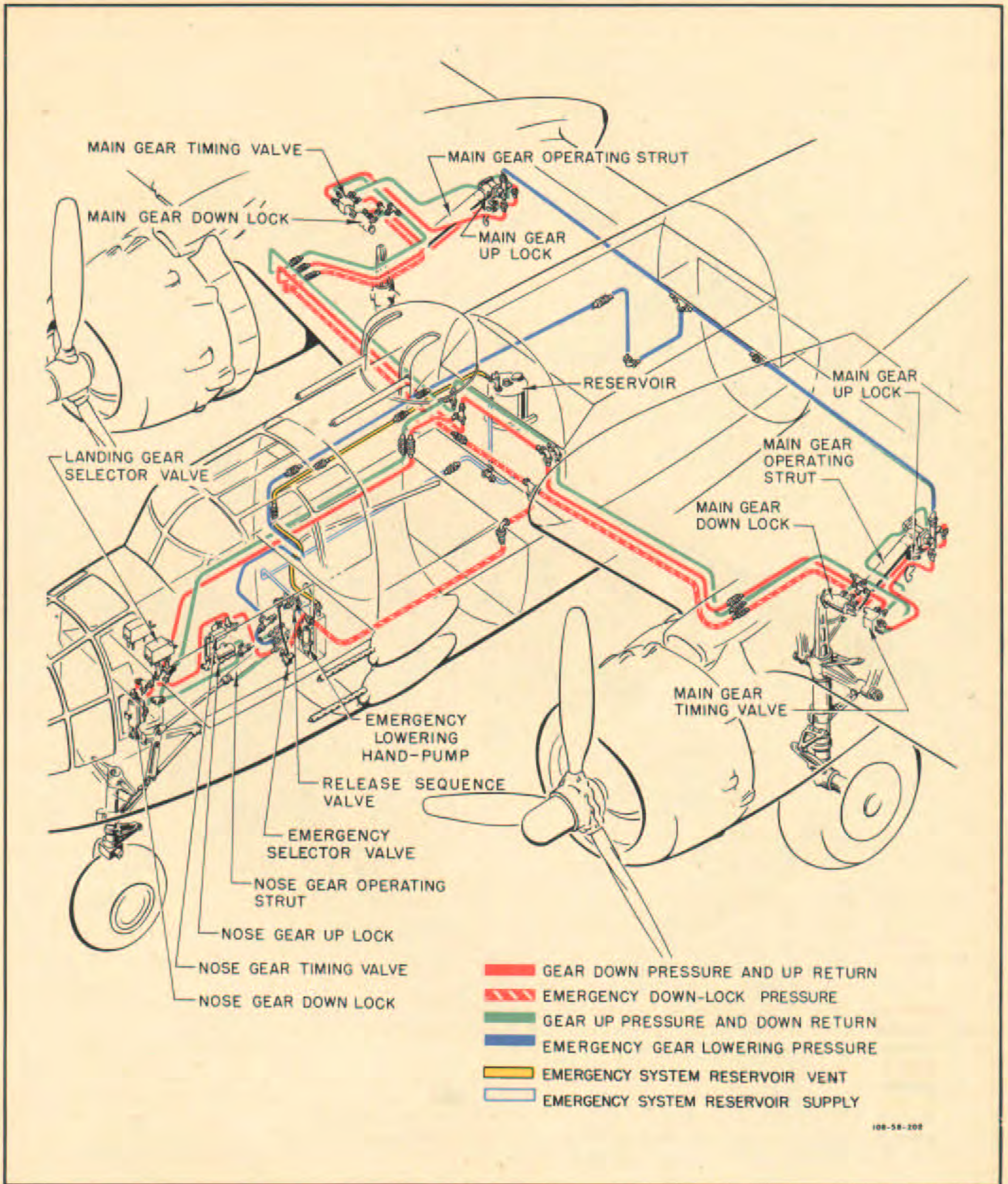

Figure 8—Hydraulic Landing Gear System

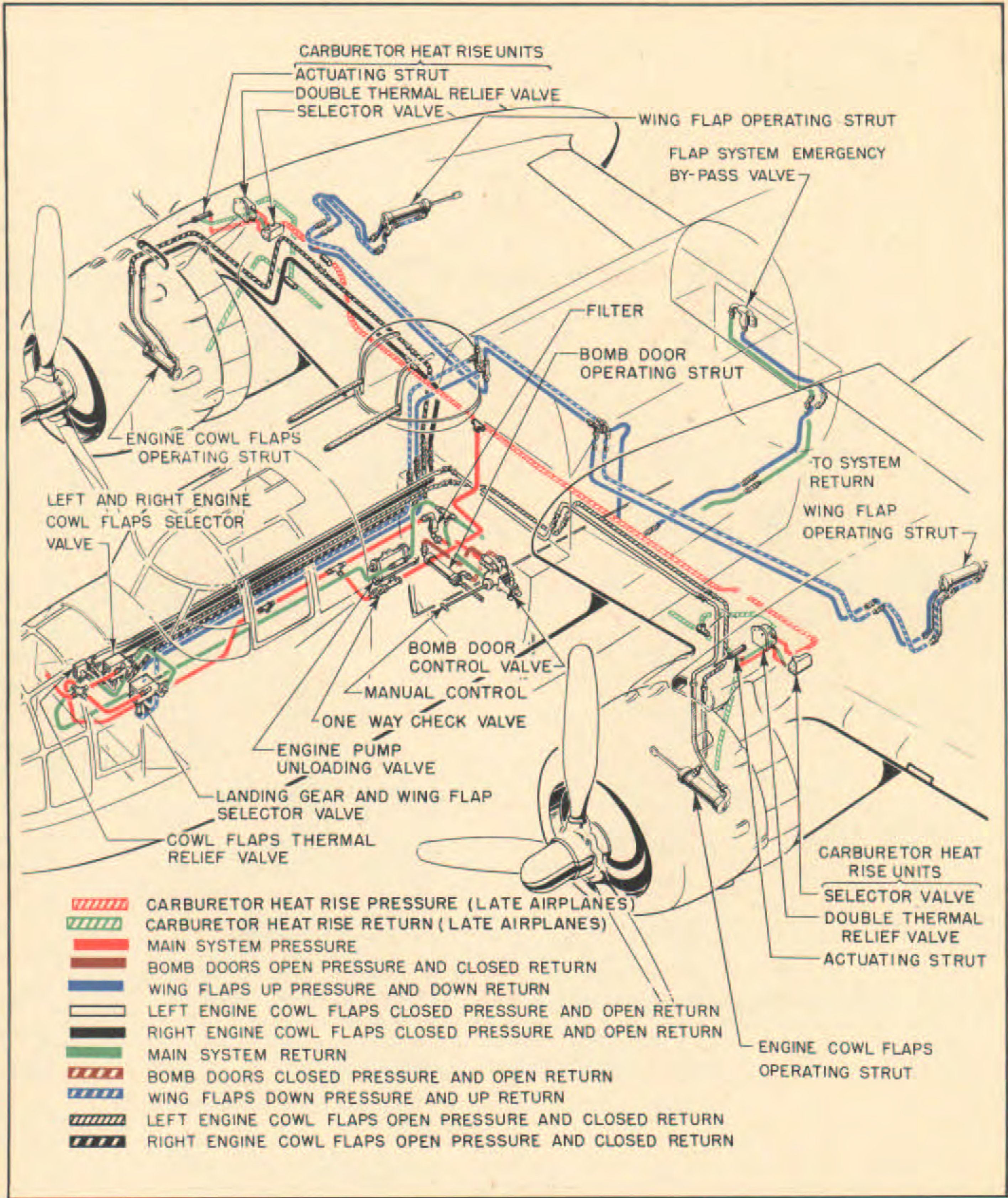

Figure 9—Hydraulic System—Wing Flaps, Cowl Flaps, Bomb Doors, and Carburetor Air Doors

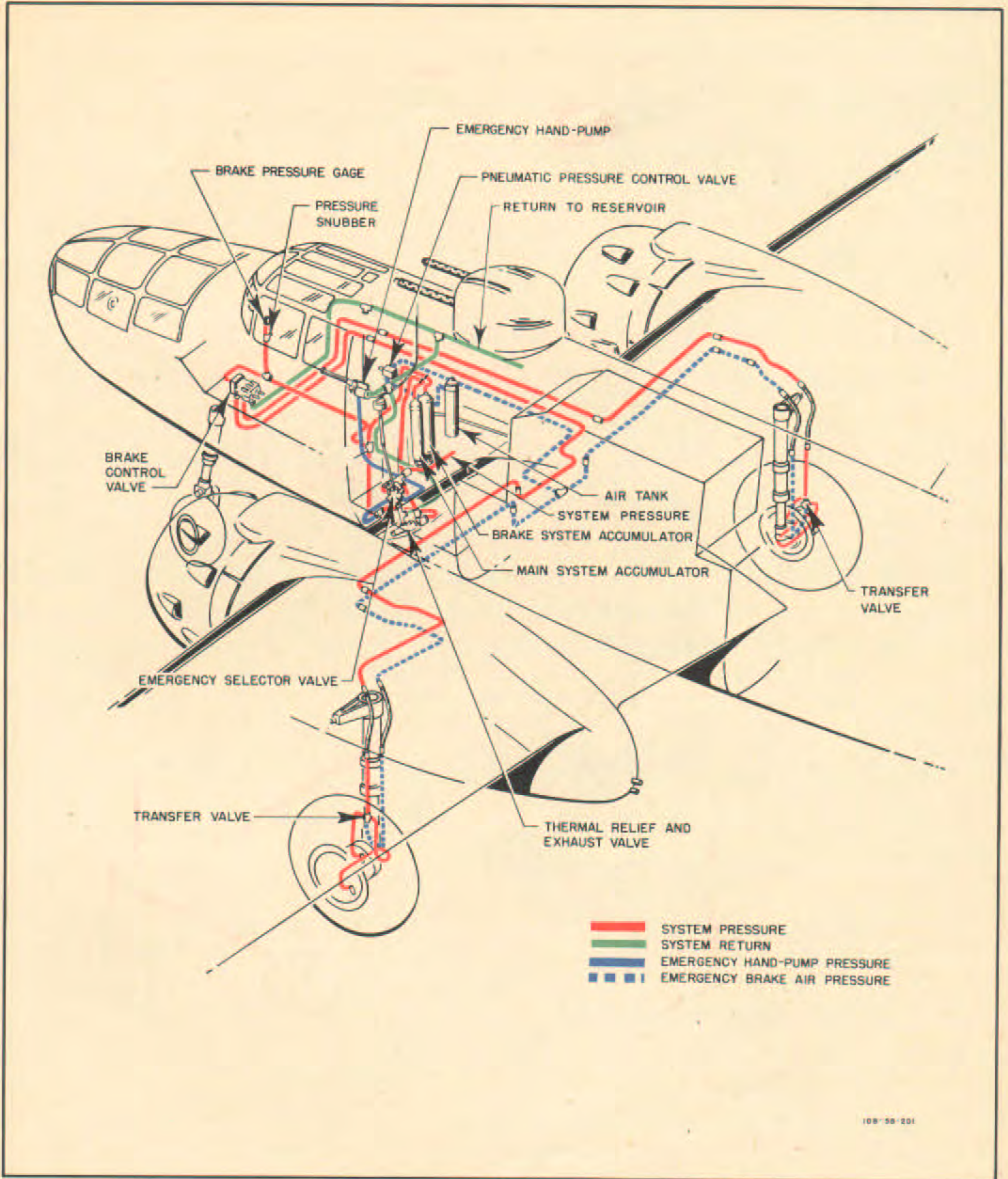

Figure 10—Hydraulic Brake and Emergency Air Brake Systems

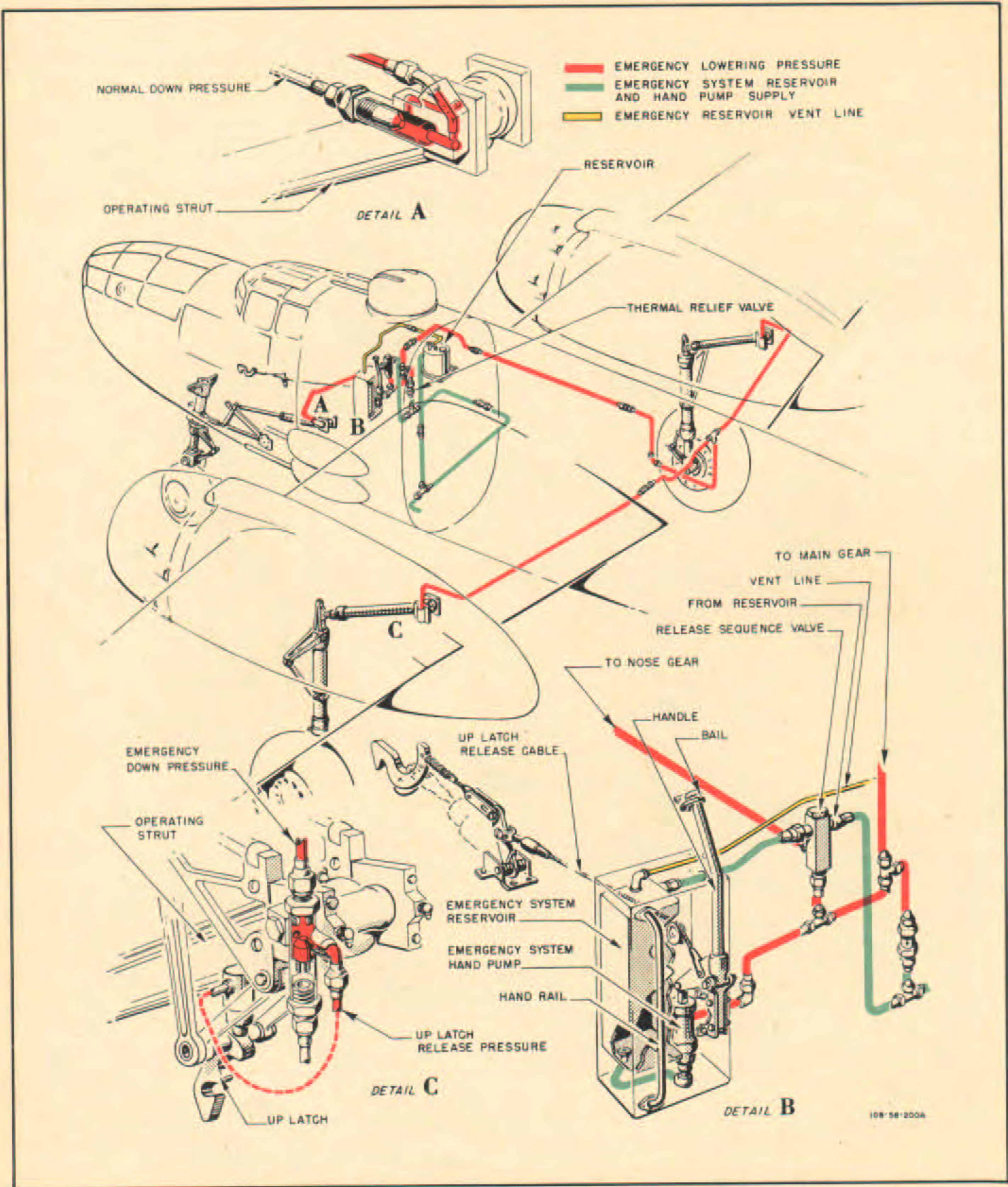

Figure 11—Landing Gear Hydraulic Emergency Lowering System

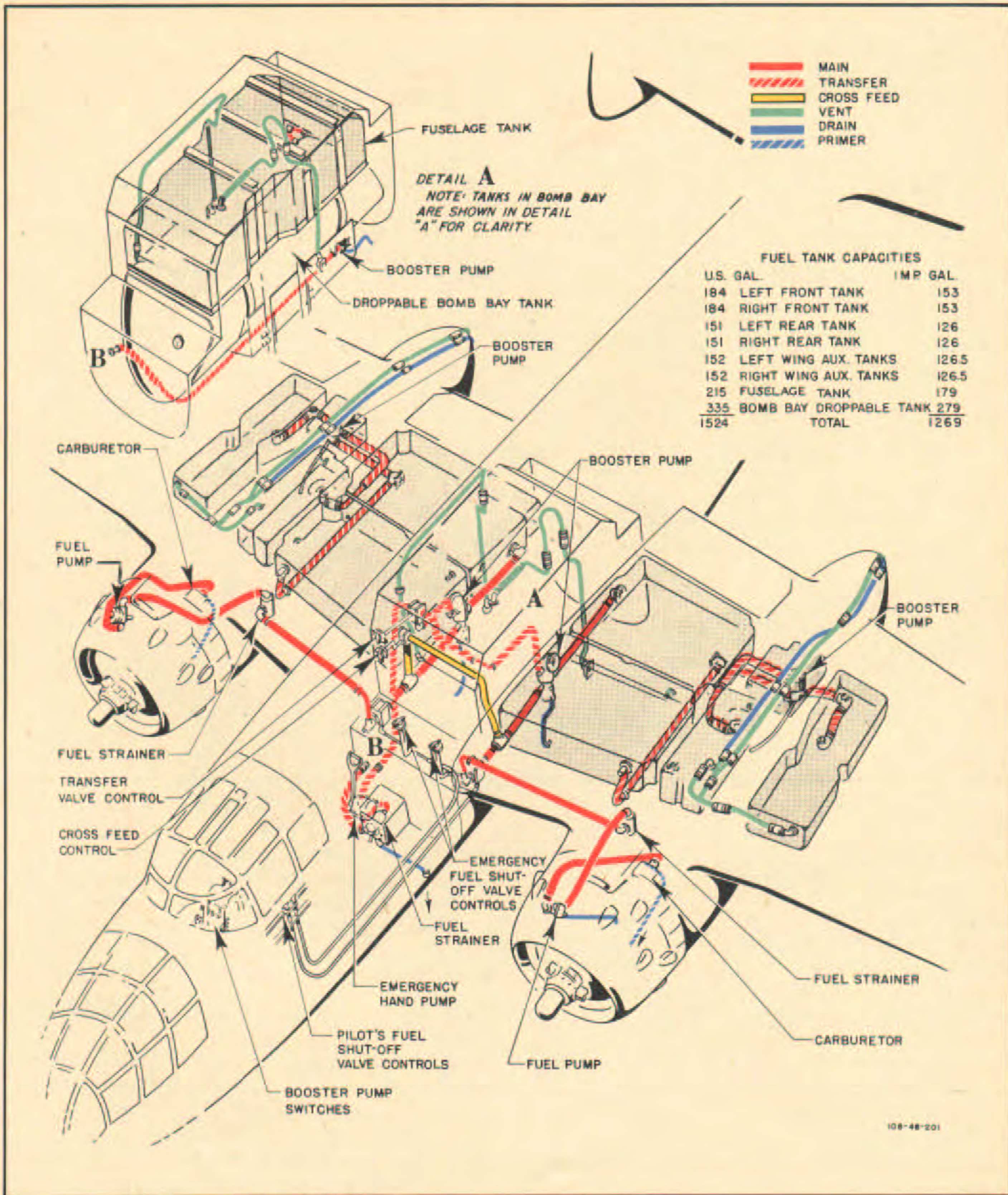

Figure 12—Fuel System

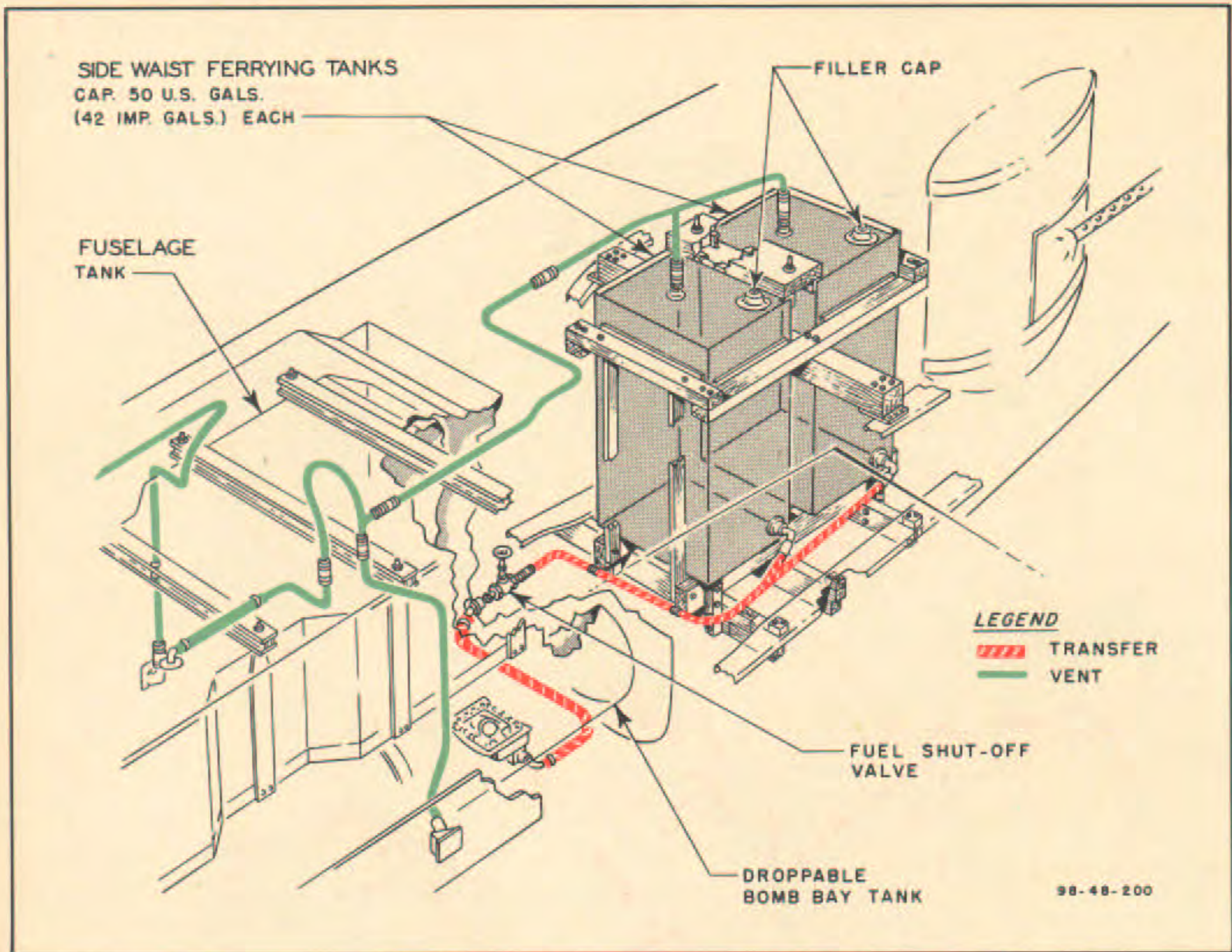

Figure 13- SIDE WAIST FERRYING TANKS

8. FUEL SYSTEM.

An independent fuel system is provided for each engine (see figure 12). The main fuel supply is carried in four self-sealing fuel tanks, two located in each wing center section between the fuselage and the engine nacelle. The auxiliary fuel supply consists of six smaller self-sealing tanks installed in groups of three in each wing center section outboard of the main fuel tanks, and a self-sealing tank in the upper portion of the bomb bay. A droppable metal tank may be installed in the bomb bay beneath the upper tank when no bombs are to be carried. The fuel flow is from the main tank, through a booster pump to a fuel strainer, then to the engine-driven fuel pump which delivers the fuel to the carburetor (see figure 22). Fuel transfer and cross-feed systems are installed (see figures 23 and 24 for fuel flow of these systems). The priming system

is electrically operated. All transfer and main feed lines are of the self-sealing type. For long-range ferrying flights, two metal tanks may be installed in the waist gunner's compartment (see figure 13).

9. OIL SYSTEM.

Each engine is provided with an independent oil system. (See figure 14.) A self-sealing oil tank is located in each nacelle. On early airplanes, oil is taken from the circulating oil to supply the propeller feathering system. On late airplanes, a standpipe in the oil tank sump provides a reserve supply of oil for propeller feathering. Scavenged oil flows through two oil temperature regulators in each wing. Air enters a scoop at the leading edge of each wing, passes through the oil radiators, and exits through apertures on the upper trailing edge of the wing. Each engine

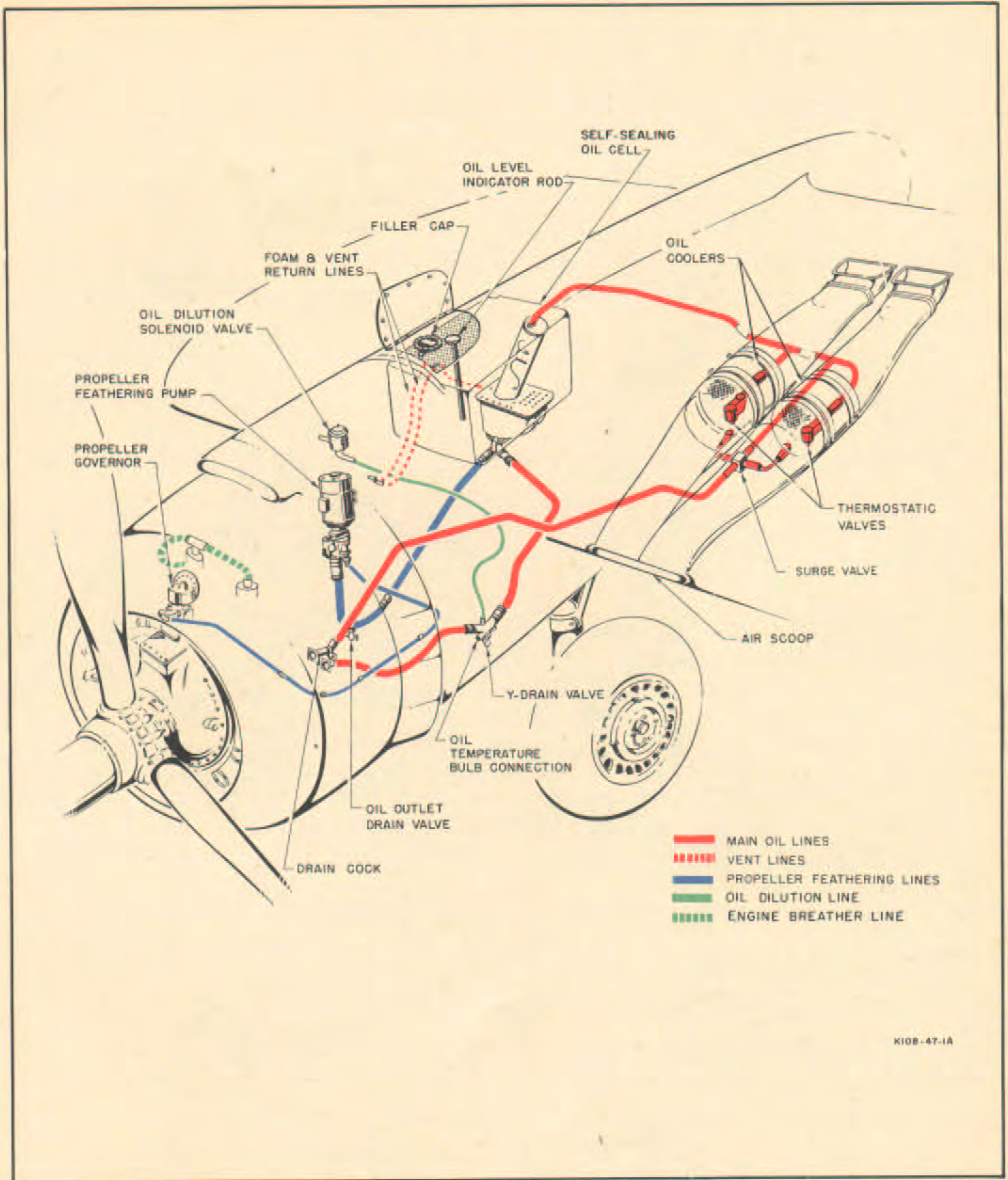

K10B-47-1A

Figure 14—Oil System

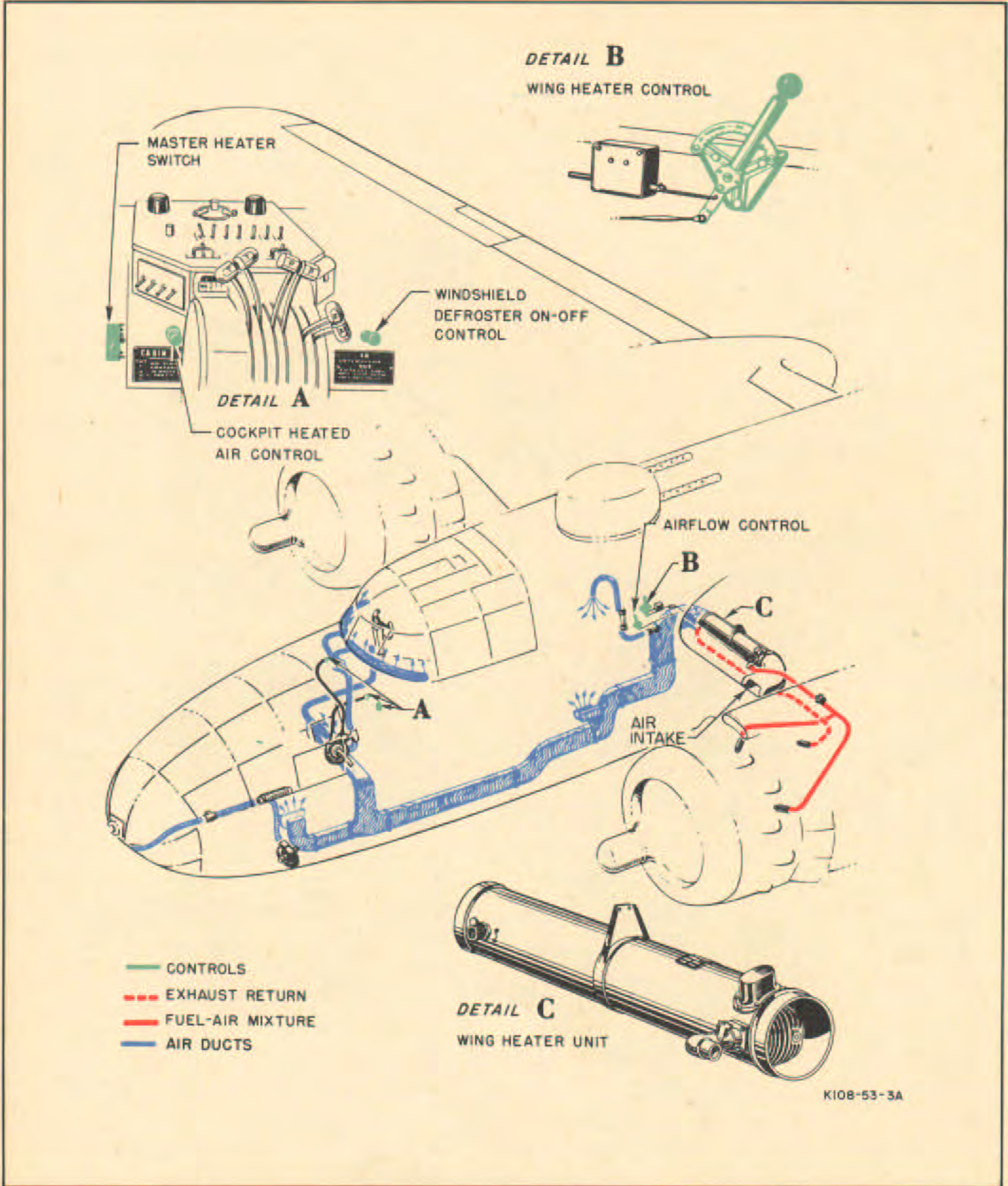

Figure 15—Heating and Ventilating System—Forward

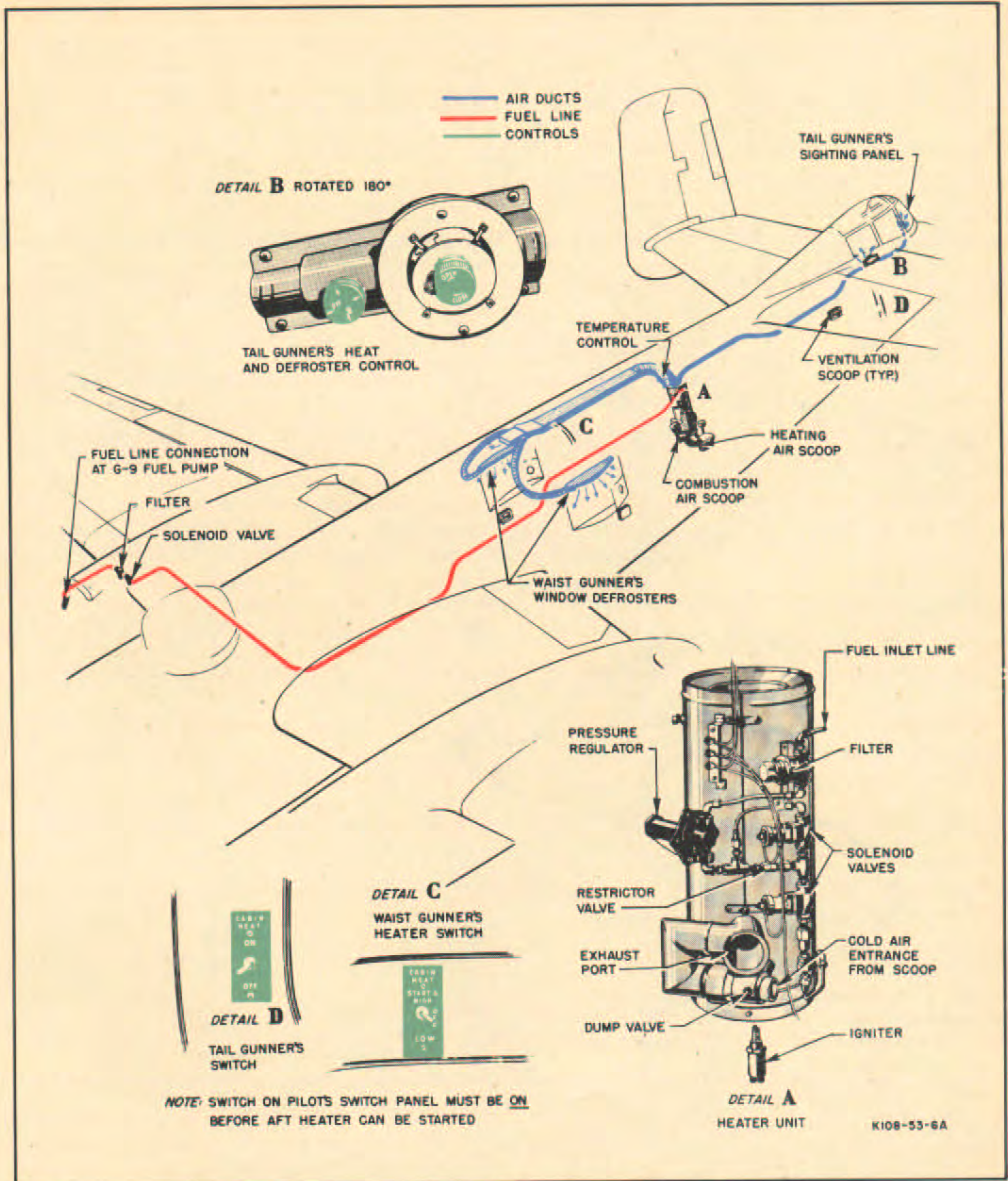

Figure 16—Heating and Ventilating System—Rear

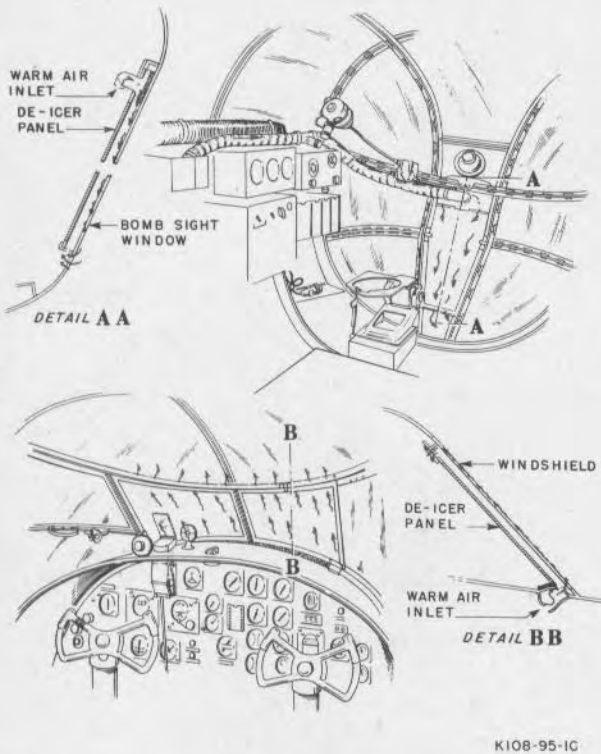

Figure 17—Defroster Panels

has an independent oil dilution system and a control switch for each system is mounted on the pilot's switch panel.

10. HEATING AND VENTILATING SYSTEM.

(For operating instructions see Sec. 5.)

a. EARLY AIRPLANES.

(1) GENERAL.—The airplane is equipped with two distinct heating systems, each operating independently of the other. The front section heating system can be operated only when the left engine is running.

(2) FRONT SECTION HEATING SYSTEM. (See figure 15.)—A heater, burning a fuel-air mixture from the supercharger, is located in the left wing center section, and the outlet ducts are installed in each forward compartment. With the heater off, the duct system may be used for ventilation in flight. Ventilators for outside air are provided in the pilot's compartment.

(3) AFT COMPARTMENT HEATING SYSTEM. (See figure 16.)—A heater, burning fuel and air mixed at the heater, is located on the left side of the aft compartment. This heater can be operated only during flight. Ventilators for outside air are provided beside the waist gun windows and in the tail turret station.

b. LATE AIRPLANES. (See figure 17A.)—A heater, burning fuel and air mixed at the heater, is located forward of the instrument panel, and outlet ducts are installed in the pilot's and bombardier's compartments. The heater is equipped with blowers in order that it may be operated on the ground. Provisions are made in the upper turret and aft compartments for the installation of additional heaters of the same type. The upper turret and aft compartment heaters may be operated only during flight.

c. DEFROSTING SYSTEM. (See figure 17.)—Removable defroster panels are attached to the bomb sight window and the pilot's and copilot's windshields. On late airplanes, the defroster panel covers the copilot's entire windshield. By means of ducts and flexible tubes, any glass area in the pilot's compartment, bombardier's compartment, the upper turret canopy, the waist gun windows, and the tail turret sighting panel may be defrosted.

11. ELECTRICAL SYSTEM.

The electrical system is of the 24-volt direct-current, single-wire type. The structure of the airplane serves as a common ground return circuit. Two engine-driven generators supply the power to charge the batteries and to operate the various electrical units. The batteries are used when the generators are not operating. The generator output is regulated to 28 volts by voltage regulators mounted on the right-hand side of the upper turret compartment. Either battery has sufficient capacity to operate the airplane's electrical system.

Note

The batteries are adequate only for a short period of direct use, and then only if they are in a properly charged condition, and if all electrically operated equipment not essential is turned off to conserve battery power.

An external power socket is located on the outboard side of the right engine nacelle, aft of the firewall. Use external power to start the engines and to operate the electrical system while the airplane is on the ground. An adapter for connecting the British type of external power supply is stowed in the external socket compartment.

12. MISCELLANEOUS EQUIPMENT.

a. DROP MESSAGE BAGS.—Five Type A-1 drop message bags are stowed as loose equipment.

b. SERVICE LADDER.—A service ladder is lashed inside the aft section of the fuselage.

c. COVERS.—Weatherproof dust covers are provided for the forward part of each engine nacelle, for the trans-

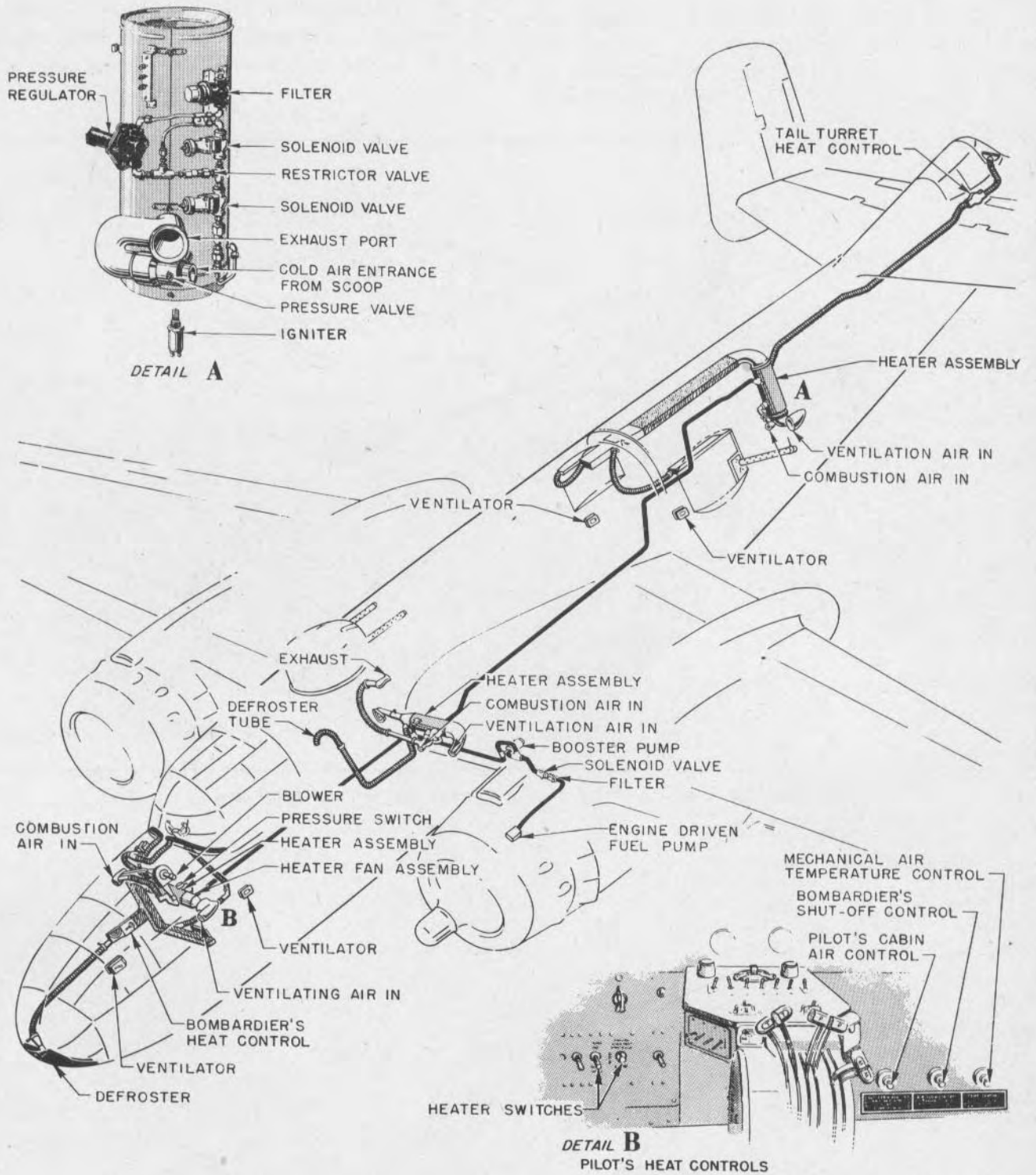

K108-53-1A

Figure 17A—Heating and Ventilating System (Late Airplanes)

parent parts of the bombardier's and pilot's compartments, the upper turret, the waist gunner's windows, and the tail gunner's station.

d. BLIND-FLYING HOOD.—On early airplanes only, a cloth hood may be suspended from the top of the pilot's enclosure during instrument-flying maneuvers. When not in use, the hood is stowed in a canvas bag underneath the

shelf on the left side of the upper turret gunner's compartment.

e. MISCELLANEOUS.—On late airplanes, resin tail light lenses, reconnaissance flares, flame floats, and drift markers are stowed on the left side of the fuselage aft of the rear entrance hatch.

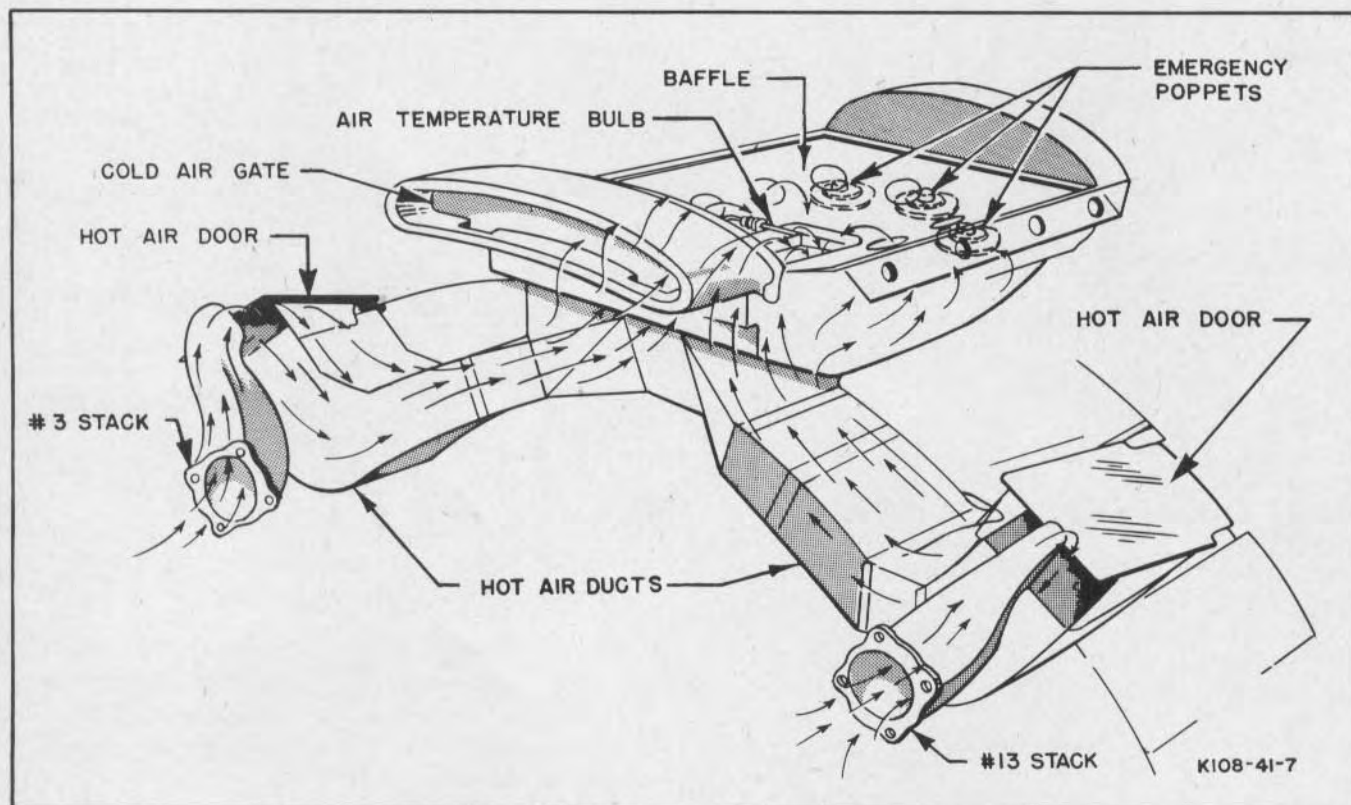

Figure 17B—Carburetor Air Induction System—Late Airplanes



SECTION II

PILOT'S OPERATING INSTRUCTIONS

NOTE

A pilot's check list in the pilot's compartment is available for a quick check of airplane operations.

1. FLIGHT RESTRICTIONS.

a. MANEUVERS PROHIBITED.

- (1) Loop.
- (2) Spin.
- (3) Roll.
- (4) Immelmann.
- (5) Inverted Flight.
- (6) Vertical Dive.
- (7) Vertical Bank.

b. AIRSPEED LIMITATIONS.

- (1) Do not exceed an indicated airspeed of 340 mph.
- (2) Do not exceed an engine speed of 2880 rpm.
- (3) Do not lower landing gear at an indicated airspeed in excess of 170 mph.
- (4) With landing gear down and wing flaps up, do not exceed an indicated airspeed of 200 mph.
- (5) Do not lower landing gear by means of emergency hydraulic lowering system at an indicated airspeed in excess of 150 mph.

(6) Do not lower wing flaps or fly airplane with wing flaps down at an indicated airspeed in excess of 170 mph.

(7) Do not lower wing flaps by means of the emergency mechanical system, or fly airplane after flaps are lowered by mechanical system at an indicated airspeed in excess of 150 mph.

(8) Do not open bomb bay doors at an indicated airspeed in excess of 290 mph.

(9) Do not operate de-icer system at an indicated airspeed in excess of 230 mph.

(10) Do not attempt to lower landing light at an indicated airspeed in excess of 175 mph.

2. BEFORE ENTERING PILOT'S COMPARTMENT.

a. Make sure that the airplane has been serviced and is ready for flight, particularly in regard to proper quantities of fuel, oil, hydraulic fluid, and oxygen.

b. Ascertain that the amount of fuel, oil, ammunition, and special equipment carried is suited to the mission to be performed and that allowable limits of weight and CG are not exceeded. (*See AN 01-1B-40.*)

c. See that airplane is headed into the wind.

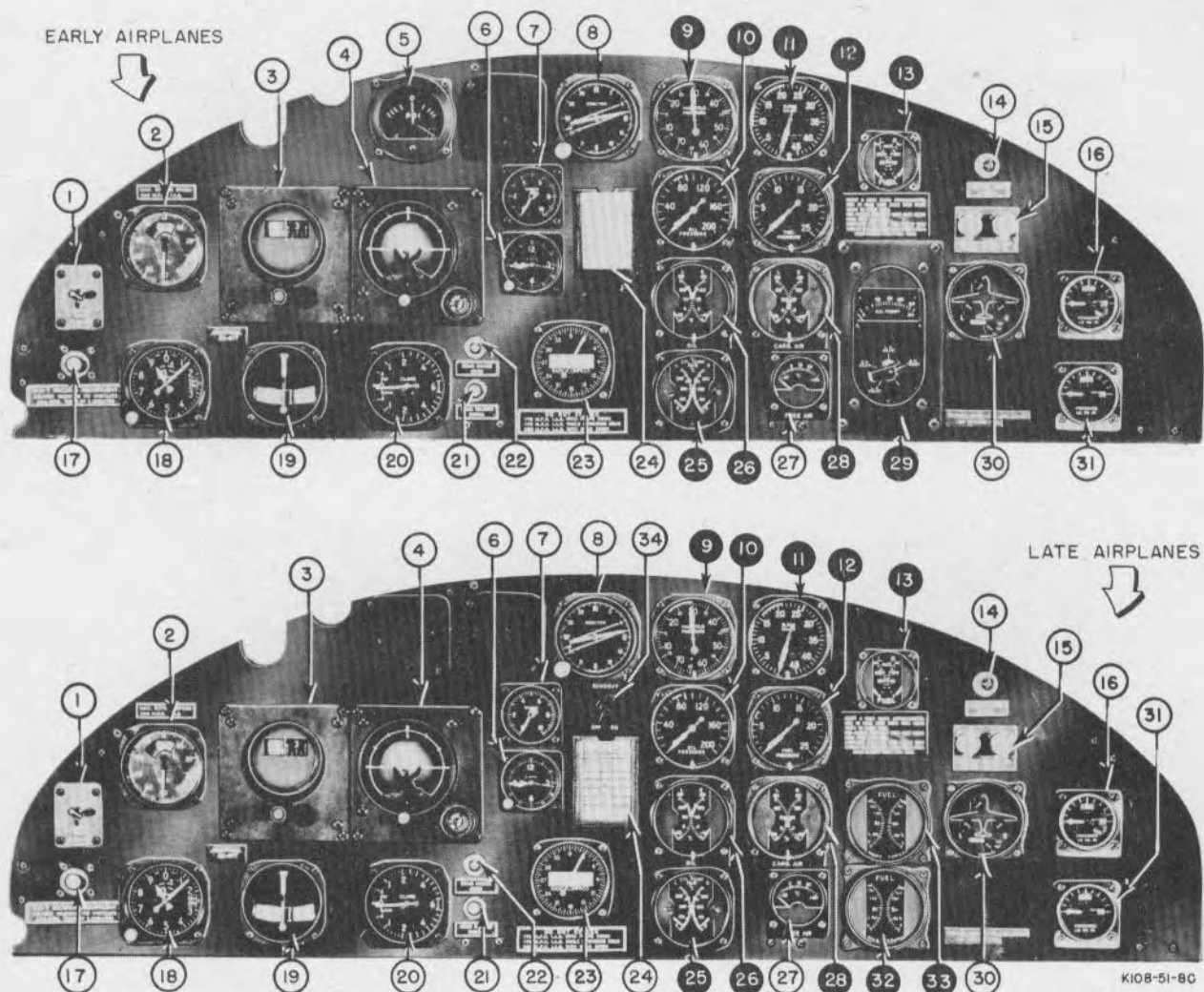

- | | |
|---|---|
| 1. Static Pressure Selector Valve | 18. Altimeter |
| 2. Airspeed Indicator | 19. Bank-and-Turn Indicator |
| 3. Directional Gyro | 20. Rate-of-Climb Indicator |
| 4. Flight Indicator | 21. Bomb Release Signal Light |
| 5. Pilot's Direction Indicator | 22. Bomb Door Indicator Light |
| 6. Clock | 23. Radio Compass Indicator |
| 7. Suction Gage | 24. Card Holder |
| 8. Remote-Reading Compass Indicator | 25. Cylinder Head Temperature Indicator |
| 9. Manifold Pressure Indicator | 26. Oil Temperature Indicator |
| 10. Oil Pressure Indicator | 27. Free Air Temperature Indicator |
| 11. Tachometer | 28. Carburetor Air Temperature Indicator |
| 12. Fuel Pressure Indicator | 29. Main Tanks Fuel Level Indicator |
| 13. Auxiliary Tanks Fuel Level Indicators | 30. Landing Gear and Wing Flap Position Indicator |
| 14. Landing Gear Warning Light | 31. Brake System Pressure Gage |
| 15. Nose Wheel Position Indicator Lights | 32. Rear Main Tanks Fuel Level Indicator |
| 16. Hydraulic System Pressure Gage | 33. Front Main Tanks Fuel Level Indicator |
| 17. Bank-and-Turn Needle Valve | 34. Gun Sight Rheostat |

Figure 18—Instrument Panels

d. Make certain nose gear towing pin is engaged (cap on).

e. Enter upper turret compartment and check the following:

(1) Switch "ON" the generator-disconnect and inverter switches, located on the generator control panel.

(2) Make certain that the fuel cross-feed valve and fuselage tank transfer valve are "OFF" (see figure 21), and the emergency fuel shut-off valves are "ON." These controls are located at the rear of the compartment. (Alternate controls for the fuel shut-off valves are located to the left of the pilot's seat.)

(3) See that deflector plate aft of upper turret is securely latched.

(4) Check emergency brake air pressure (550-600 lbs./sq. in.).

(5) Check hydraulic and brake accumulator pressures for a minimum of 400 lbs./sq. in.

f. Check to determine whether or not the engines are identified with a one-inch yellow stripe around the nose section at the thrust-bearing location, as this identifies engines equipped with clutch control synchronizer valves.

3. ON ENTERING PILOT'S COMPARTMENT.

a. The following procedure should be carried out prior to all flights:

(1) Have waist gunner make certain that wing flap emergency crank is stowed.

(2) Have upper turret operator make sure that bomb door emergency crank is stowed.

(3) Have crew members unlock emergency ground-escape hatches.

(4) Check movable armor plate door to see that it is securely latched.

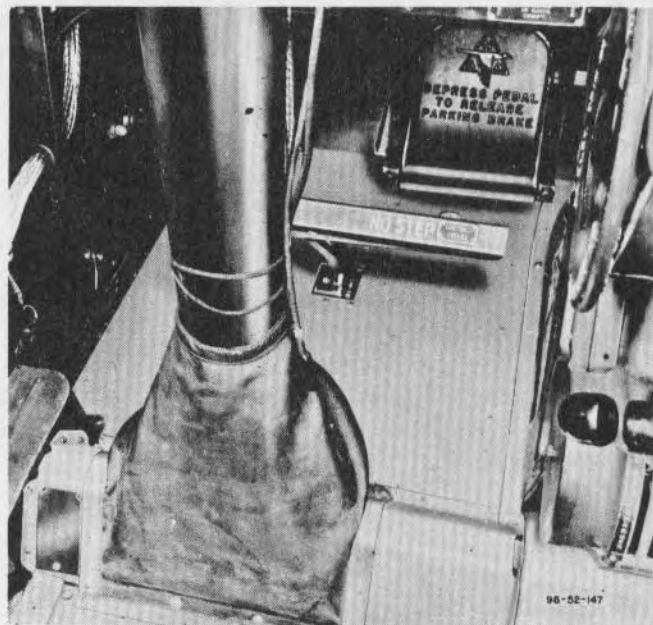

Figure 19—Surface Control Lock Handle

(5) See that ignition switches are "OFF."

(6) Set parking brakes.

(7) Unlock flight controls and check for free and proper movement, watching control surfaces for correct response.

(8) Make sure that bomb control switches are in their inoperative positions (see figures 36 and 37).

(9) See that safety switch for the guns is in "SAFE."

(10) Set altimeter to the correct barometric pressure.



Figure 20—Pilot's Switch Panel

(11) Test gun sight illumination by operating rheostat control.

(12) When glide bombing attachment is removed, have bombardier make certain the selector valve in the bombardier's compartment is safetied in the "ALTERNATE SOURCE" position.

(13) If both engines are identified with a yellow stripe around the nose section, check pilot's check list to insure that the note has been added giving operation of clutches in engines identified with yellow stripe.

b. When night flying is anticipated, the following additional checks should be made.

(1) Test fluorescent instrument lights by operating rheostat control on side of each control column.

(2) Test cockpit extension light on right-hand instrument subpanel.

(3) Test position lights by moving switches on pilot's switch panel to "BRIGHT" and "DIM."

(4) Test landing lights by operating switches on control pedestal switch panel. On late airplanes, test landing lights (with aid of outside observer) by moving switches to "EXTEND." After test, move switches to "RETRACT," then to "OFF."

WARNING

Do not leave the landing lights on when the airplane is on the ground.

(5) Test operation of recognition lights. Switches are located on control pedestal switch panel.

Note

Do not operate recognition lights longer than 10 seconds on the ground.



Figure 21—Fuel Transfer and Cross-feed Controls

4. FUEL SYSTEM MANAGEMENT.

(See figures 22, 23, and 24.)

a. AUXILIARY FUEL.—Fuel in the auxiliary cells must be transferred to the main fuel cells before it can be fed to the engine. To transfer fuel, start one or both of the auxiliary fuel cell transfer pumps by placing the switches on the control pedestal switch panel in the "ON" position. There are no valves to be opened or closed during this operation. Whenever the quantity of fuel in a main fuel cell has been reduced sufficiently, as shown on the liquidometer fuel level indicator, fuel should be transferred from the auxiliary cells. During this transfer the selector switch on the liquidometer indicator should be set to the front main cell to which the fuel is being transferred, in order to inform the pilot when to turn off the transfer pump. The transfer pump should not be kept running after the cell is full, since leaky filler caps may cause loss by overflow. If there is no leakage at the filler caps, fuel will be circulated back to the auxiliary fuel cells through the vent connections.

b. FUSELAGE TANK FUEL.—Before the fuel carried in any fuselage tank may be used, it is necessary to transfer the fuel to the left or right front main fuel cell. To transfer fuel, proceed as follows:

(1) Turn fuel transfer valve control from "OFF" position to either "FUS. TANK TO LEFT WING" or "FUS. TANK TO RIGHT WING."

(2) Turn "ON" transfer pump switch on generator control panel.

(3) Set main liquidometer selector switch to the main fuel cell to which fuel is being transferred. Watch gage in order that transferring operation may be stopped when cell is full, to avoid overflow.

Note

It is desirable to maintain main fuel tanks as nearly full as possible by transfer of fuel from the various fuselage tanks. When the DROPPABLE BOMB BAY TANK is carried, fuel flow from FUSELAGE TANK and SIDE WAIST TANKS is through the DROPPABLE BOMB BAY TANK. If an emergency makes it necessary to jettison the DROPPABLE BOMB BAY TANK all fuel in the various fuselage tanks will be lost.

(4) When transfer operations are finished, shut "OFF" transfer pump switch and place fuel transfer valve control in "OFF" position.

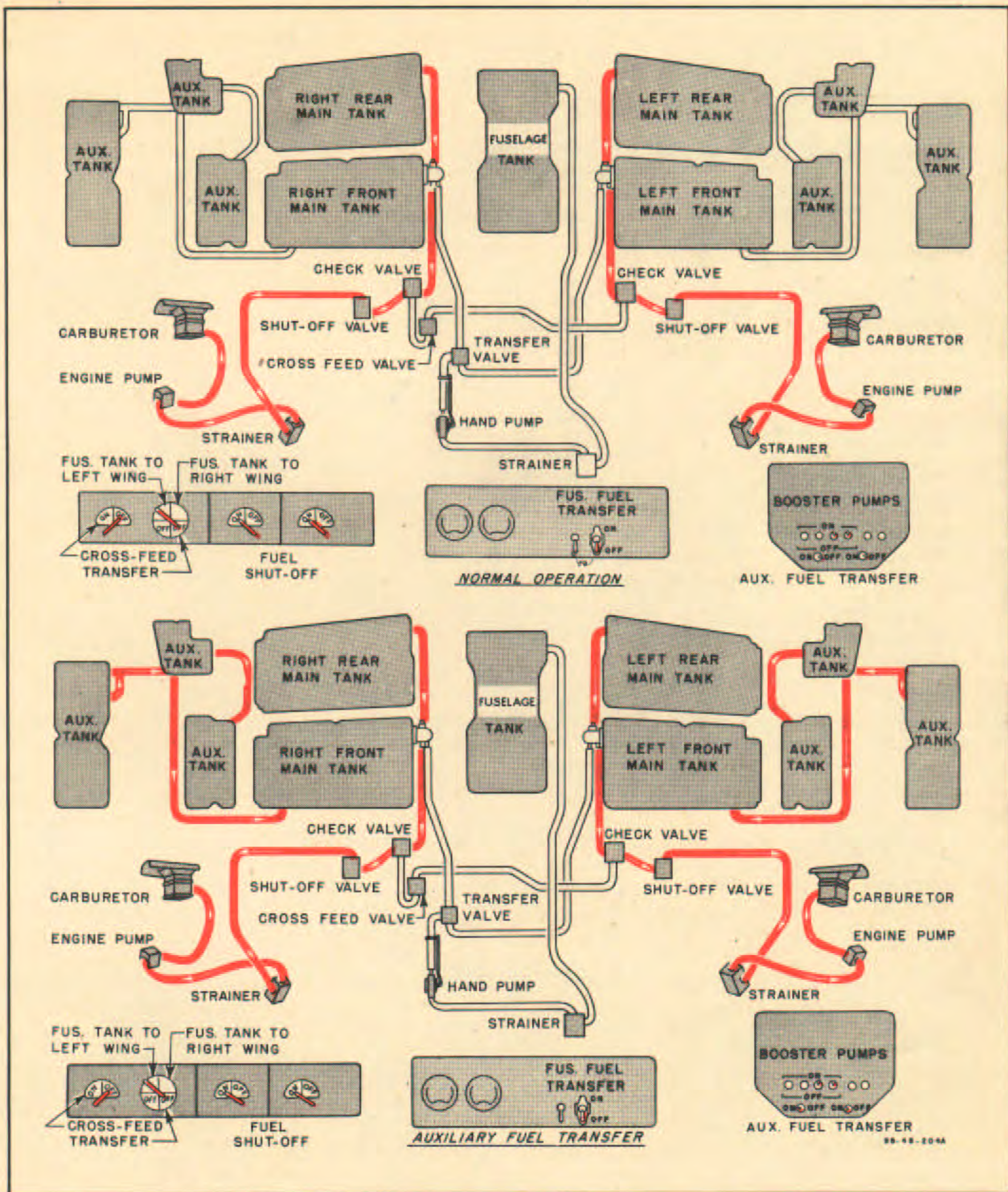

Figure 22—Fuel System Management—Normal Operation Auxiliary Transfer

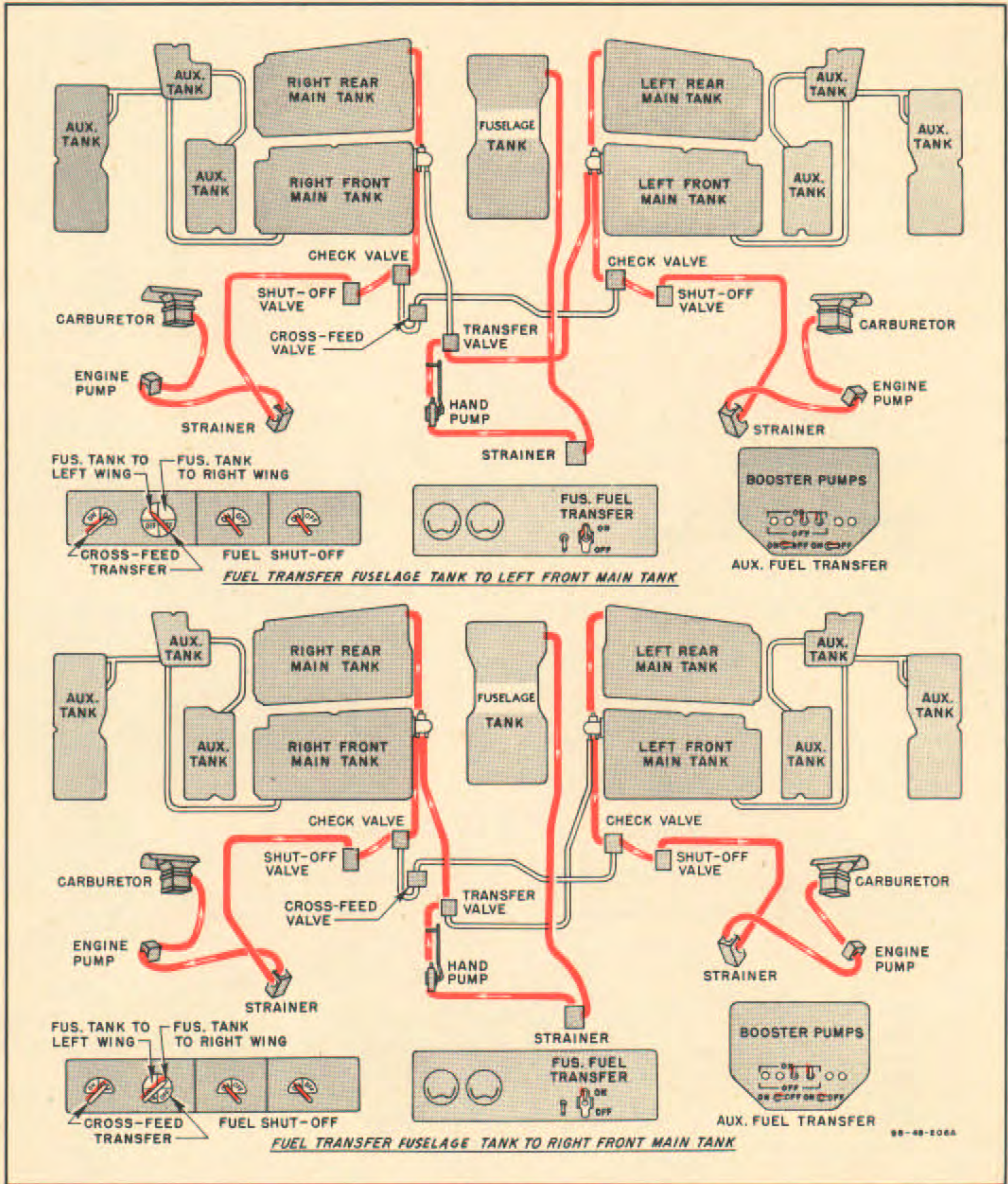

Figure 23—Fuel System Management—Fuel Transfer

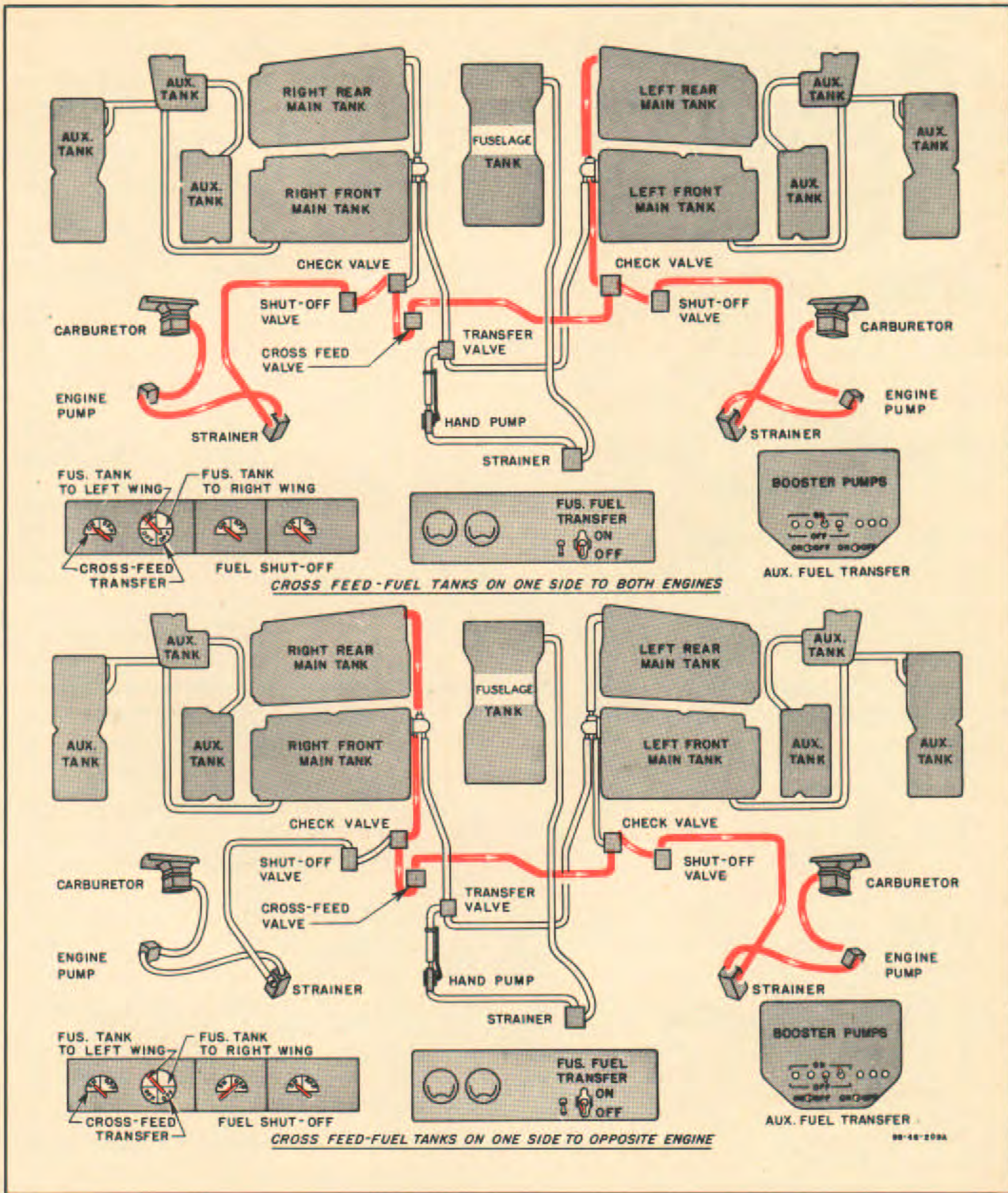
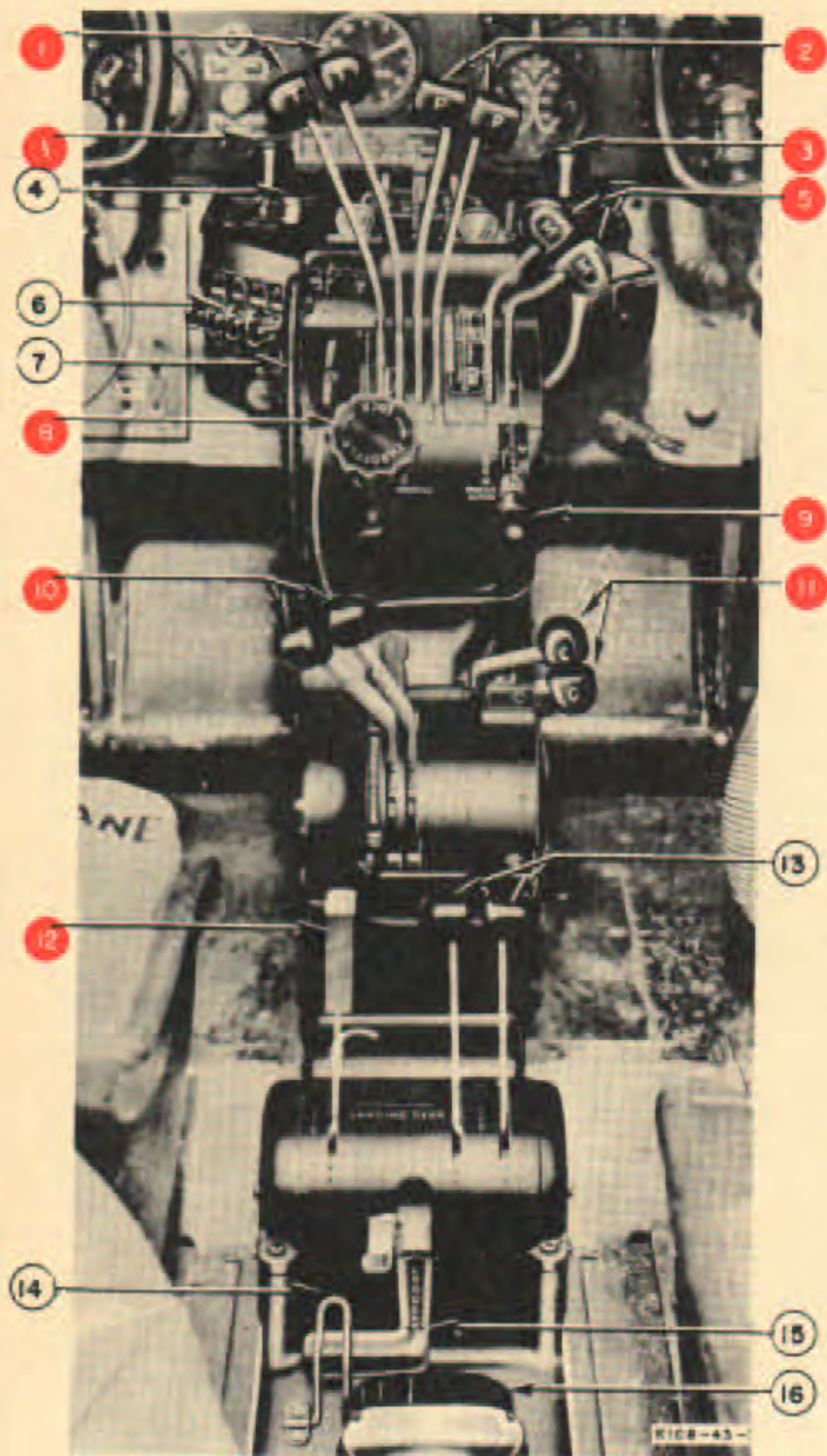

Figure 24—Fuel System Management—Cross Feed



1. Throttles
2. Propeller Controls
3. Propeller Feathering Buttons
4. Recognition Light Keying Switch
5. Mixture Controls
6. Recognition Light Switches
7. Elevator Trim Tab Control Wheel
8. Throttle Friction Lock
9. Propeller and Mixture Control Lock
10. Supercharger Controls
11. Carburetor Air Controls
12. Wing Flap Control
13. Cowl Flap Controls
14. Landing Gear Control Lock
15. Landing Gear Control
16. Aileron Trim Tab Control

Figure 25—Engine Control Pedestal

c. EMERGENCY FUEL TRANSFER.—If fuselage tank transfer pump fails, proceed as follows:

(1) Set transfer valve control to desired position and unstrap handle on pump at base of turret in upper turret compartment.

(2) Move handle back and forth. This action draws fuel from the fuselage tank and pumps it into whichever main cell has been selected.

(3) When transfer operation is completed, return handle to stowed position and strap in place. Return selector valve control handle to "OFF" position.

d. FUEL CROSS-FEED.—The cross-feed system is for emergency use only, and the cross-feed valve is left "OFF" except when the system is in use.

(1) If one engine fails, turn "OFF" the fuel shut-off valve for that engine to reduce fire hazard. Operate the other engine in the normal manner, using fuel from the tanks on that side of the airplane. When this supply is near exhaustion, turn "OFF" the booster pump for those cells; then turn on the booster pump for the fuel tanks on the opposite side of the airplane and also turn "ON" the cross-feed valve. Fuel from these tanks will then flow to the operating engine.

(2) If fuel is lost from the wing cells on one side of the airplane, both engines may be operated on fuel carried in the other wing cells by turning "ON" the booster pump switch for the undamaged cells and turning "ON" the cross-feed valve.

5. STARTING ENGINES.

a. Follow this sequence of operations when starting the engines:

(1) With ignition switch OFF, have ground personnel turn propellers 3 or 4 revolutions by hand.

(2) Move fire extinguisher selector valve control to engine to be started.

(3) Open throttles $\frac{3}{4}$ inch (1000-1200 rpm). As engine starts, retard throttle slightly.

Note

No priming action or fuel discharge is accomplished by pumping the throttle.

(4) Move propeller controls to full "INCREASE RPM."

(5) Move mixture controls to "IDLE CUT OFF."

(6) Make certain that the supercharger controls are locked in "LOW."

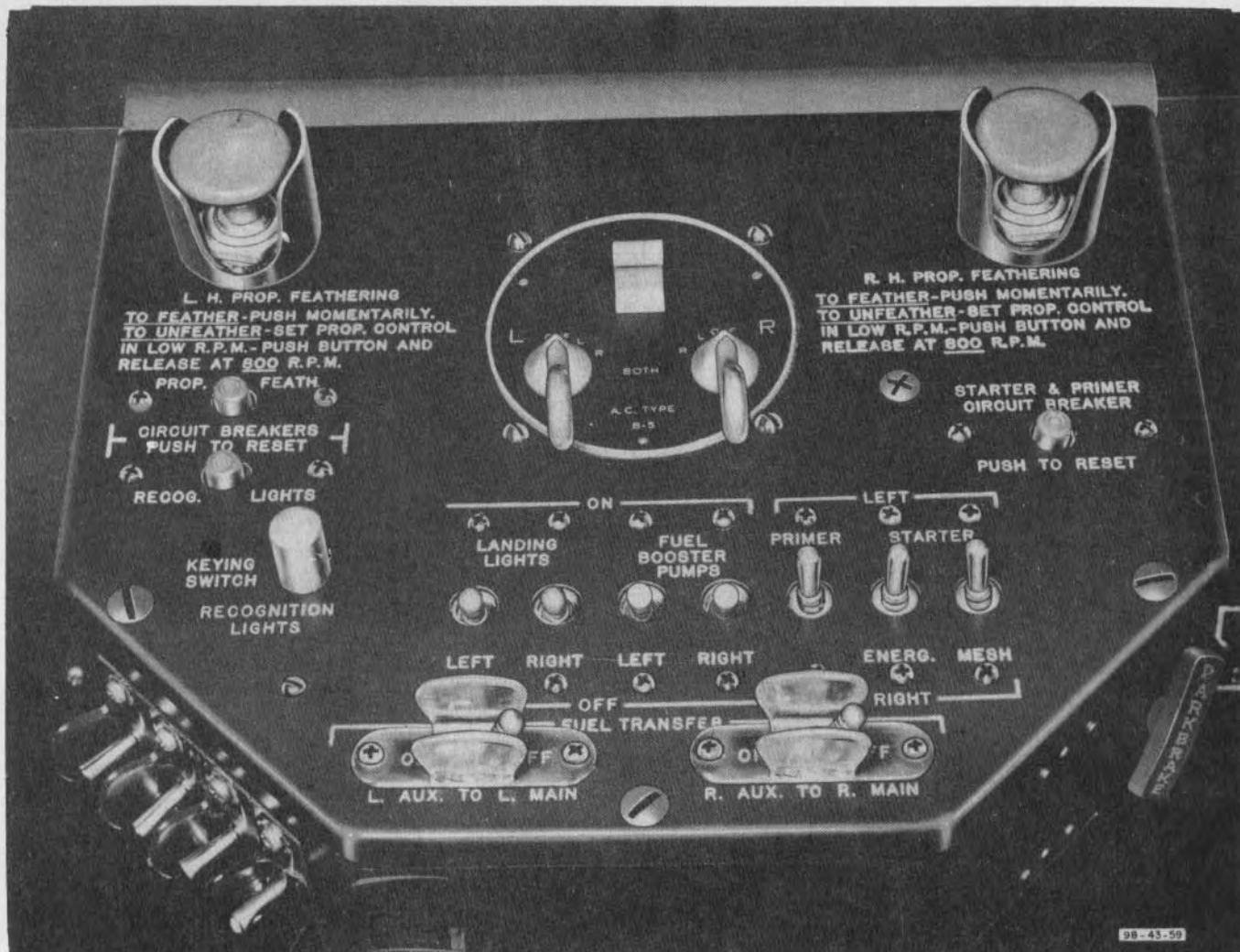

Figure 26—Control Pedestal Switch Panel

(7) Open cowl flaps; then place controls in neutral.

Note

Always return the cowl flap control to neutral position immediately after obtaining the desired position of the flaps. In this position, fluid will not be pumped overboard should a cowl flap line break.

(8) On early airplanes, move carburetor air controls to "NORMAL." On late airplanes, see that carburetor air controls are in neutral position, and visually check to see that carburetor air scoop gates are open and that exhaust scoops are closed.

(9) Check emergency fuel shut-off valve controls "ON."

(10) If external power supply is not connected

turn "ON" the battery-disconnect switches, located on the pilot's switch panel (see figure 20).

(11) Turn "ON" the fuel booster pump switches, located on the control pedestal switch panel (see figure 26). Check the fuel pressure gage for 4 to 5 lbs./sq.in. pressure.

(12) Turn "ON" the ignition safety switch, located on the pilot's control pedestal.

(13) Turn the ignition switch for the engine to be started first to the "BOTH" position.

(14) Press starter energizing switch on control pedestal switch panel to "LEFT" or "RIGHT," depending on which engine is being started first, and hold in place for a maximum of 10 seconds when using an external power source (battery cart), or 20 seconds when using the airplane's batteries.

Note

Whenever possible, an external power supply should be used to start the engines. If external power is not available, use a portable energizer or handcrank. Do not use airplane's batteries to start engines except in an emergency.

(15) While energizing, prime engine 2 seconds.

(16) Check to see if propeller is clear.

(17) Press mesh switch to "LEFT" or "RIGHT," depending on which engine is being started first. Prime the engine while engaging until it fires evenly.

(18) As engine starts, move mixture control to "FULL RICH."

(19) Check oil pressure. If pressure is not up to 40 lbs./sq.in. within 30 seconds, stop engine and investigate.

(20) Follow procedures (2) and (13) through (19) for starting other engine.

6. ENGINE WARM-UP.

a. Warm engine at 1200 rpm until oil temperature shows a definite increase and oil pressure remains steady when throttle is opened.

b. The gyro instruments should be uncaged at all times except during maneuvers which exceed operating limits.

Note

If horizon bar on flight indicator is not level after engines are started, cage, then immediately uncage gyro at least 5 minutes before take-off.

c. If outside air temperature is below -23°C (-10°F), use carburetor heat to maintain smooth engine operation.

7. EMERGENCY TAKE-OFF.

Use oil dilution to obtain proper oil pressure at moderate power, and as soon as the engine will take the throttle, taxi out and take off. Apply throttle slowly but steadily.

WARNING

Overdilution may easily result in very low oil pressure after the engine is warm; therefore, dilution should be used carefully.

8. ENGINE AND ACCESSORIES GROUND TEST.

a. After starting, engines should be warmed up and ground tested as follows:

(1) Turn booster pumps "OFF" and check for a fuel pressure of 6 to 7 lbs./sq.in.

(2) Check propeller controls at 1600 rpm by pulling controls back to full "DECREASE RPM" and noting rpm drop of approximately 350 to 400 rpm. Return controls to full "INCREASE RPM."

(3) Check "L" and "R" magnetos at 2000-2100 rpm, maximum manifold pressure, 28.5 in. Hg—maximum rpm drop 75. If rpm drop is greater, return switch to "BOTH," run engine to 40 in. Hg manifold pressure for a few seconds and then recheck at 2000-2100 rpm.

(4) At 700 rpm, check "OFF" position of ignition switches.

(5) Check supercharger clutch. With clutch control placed in "LOW" position and propeller set in full low pitch, set engine speed with throttle to 2000 rpm. Note manifold pressure reading. Then move supercharger control to "HIGH" position. A decided increase in manifold pressure indicates that "HIGH" ratio clutch is operating properly. To shift back to "LOW" reduce the engine speed by use of the throttle to 1500 rpm or less. Then move supercharger clutch control lever to "LOW" position. In order to insure that the clutch control is properly engaged in "LOW" ratio, increase rpm to 2000 and check to see that manifold pressure is the same as that previously obtained at 2000 rpm in "LOW" ratio.

Note

In aircraft in which both engines are identified with yellow stripe around the nose section, clutches will be checked in the same manner as above, except that all shifts will be made at 1700 rpm or above. If one of the engines does not have a yellow stripe around the nose section, clutch operations on both engines will be as directed in preceding paragraph.

(6) Check operation of cowl flaps and wing flaps.

(7) At 1600 rpm, check voltage at 28-28.5, amperes 20-60 per generator, and suction 3.75-4.25 in. Hg.

(8) Check hydraulic pressure (800-1100 lbs./sq.in.).

(9) Check brake pressure (1000-1200 lbs./sq.in.).

(10) Check communication equipment for proper operation.

(11) Check with crew members to see that entrance hatches are closed.

9. TAXIING.

a. GENERAL.—When taxiing, the airplane must begin to roll freely from its stationary position before any attempt is made to change direction. No turn should be attempted until the initial direction has been determined by "giving the airplane its head" through the even application of the engines without the use of brakes.

Note

This restriction is necessary because of the excessive side loads developed in the nose wheel assembly.

b. **TURNS IN MUD OR SAND.**—While taxiing in mud or sand, turn the airplane by moderate use of the brakes and engines, avoiding pivoting on one wheel. The minimum radius of turn of the inside wheel can be approximately 10 feet. When attempting to straighten the airplane out of a turn, it will be found that the nose wheel has less tendency to trail properly as the depth of the tire sink (depth of rut) increases.

c. **NOSE WHEEL TURN INDICATOR.**—An indicator containing two warning lights is installed on the instrument panel. These lights serve to warn the pilot when the nose wheel is turned beyond 15 degrees in either direction. Their action is fully automatic. The brilliancy of the lights may be adjusted by twisting the jewel light caps to "DAY" or "NITE."

Note

Upon reaching the take-off position, stop the airplane cross-wind so that approaching airplanes may be plainly seen.

10. BEFORE TAKE-OFF.

a. Check the following:

- (1) Cabin heat switch "OFF."
- (2) Turrets pointing directly aft; waist guns stowed.
- (3) Check flying controls for free movement (watch control surfaces).
- (4) Check elevator, aileron, and rudder trim. (See figure 3-31 and figure 27.)
- (5) Generator and inverter switches "ON."
- (6) De-icer control "OFF" if de-icers are installed.
- (7) Check fuel levels.
- (8) Fuel booster pumps "ON." Fuel pressure 6-7 lbs./sq.in.
- (9) Propeller full "INCREASE RPM."
- (10) Mixture "FULL RICH" (lock snug).
- (11) Supercharger "LOW" (locked).
- (12) If outside air temperature is below -23°C (-10°F), use carburetor heat to maintain smooth engine operation.
- (13) Cowl flaps "OPEN" (control neutral).
- (14) Emergency hydraulic selector valve "NORMAL."
- (15) Emergency brake control safetied. Air pressure 550-600 lbs.

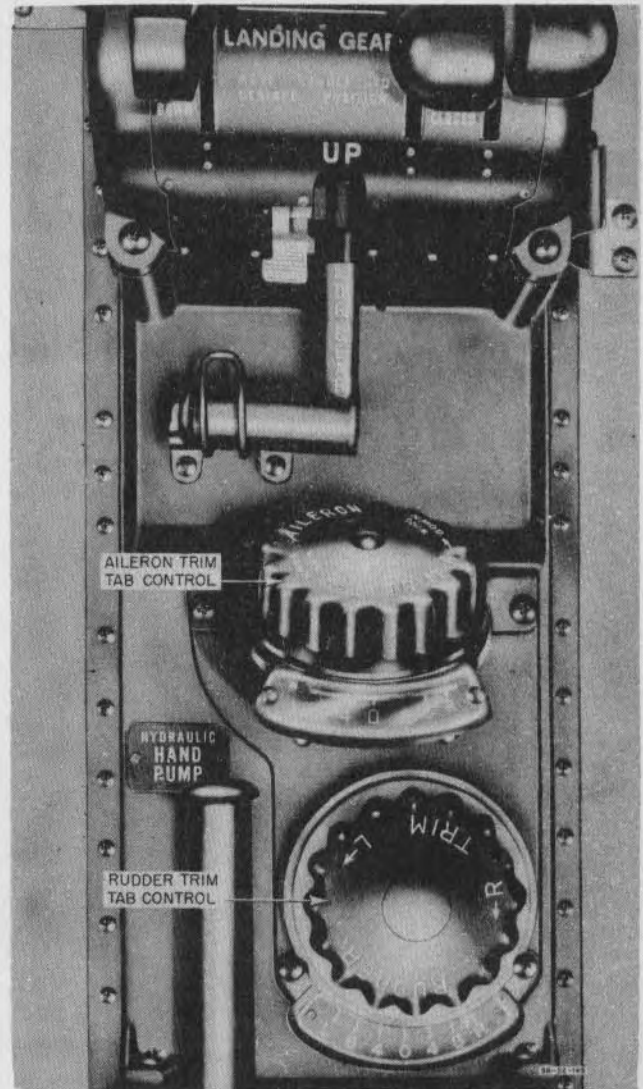

Figure 27—Aileron and Rudder Trim Tab Controls

- (16) Pilot's static pressure selector valve "AIRSPEED TUBE" position.

11. TAKE-OFF.

a. When the field is clear, quickly check the following:

- (1) Wing flaps 20° down for normal take-off, 30° down for obstacle clearance (control neutral), or as conditions dictate.
- (2) Cylinder temperature 260°C (500°F) maximum for 5 minutes.
- (3) Oil pressure 75-90 lbs./sq.in.
- (4) Oil temperature 40°C (104°F) minimum, 95°C (203°F) maximum.

b. Open throttles to 44.3 in. Hg manifold pressure at 2600 rpm, and take off (5 minutes maximum).

WARNING

When airplane is serviced with fuel, Grade 91, Spec. No. AN-F-26, operate engines within limits specified on decal on pilot's control column.

12. ENGINE FAILURE DURING TAKE-OFF.

a. The chances of an engine failure during take-off can be greatly reduced if the engines are run up carefully and checked thoroughly before take-off.

b. The hazards due to engine failure during take-off can be minimized by observing the following practices:

(1) Hold airplane down after take-off in order to reach single-engine control speed as soon as possible. At take-off power the minimum single-engine control speeds are approximately as follows:

Right engine inoperative: 133 mph (IAS)

Left engine inoperative: 145 mph (IAS)

(2) Retract the landing gear as soon as the airplane is definitely airborne.

(3) Retract flaps as soon as the airplane reaches a safe altitude.

c. If an engine fails during take-off, the pilot must at once decide whether he can feather the propeller on the inoperative engine and continue flight, or should cut the good engine and land straight ahead. The decision to continue flight will be based upon the following factors:

(1) AIRPLANE SPEED. — Minimum single-engine control speed must be obtained. (See paragraph b. (1).)

(2) AIRPLANE CONFIGURATION. — No climb is possible unless gear is retracted, and the propeller on the inoperative engine is either feathered or set at full "DECREASE RPM." Climb performance is improved by clos-

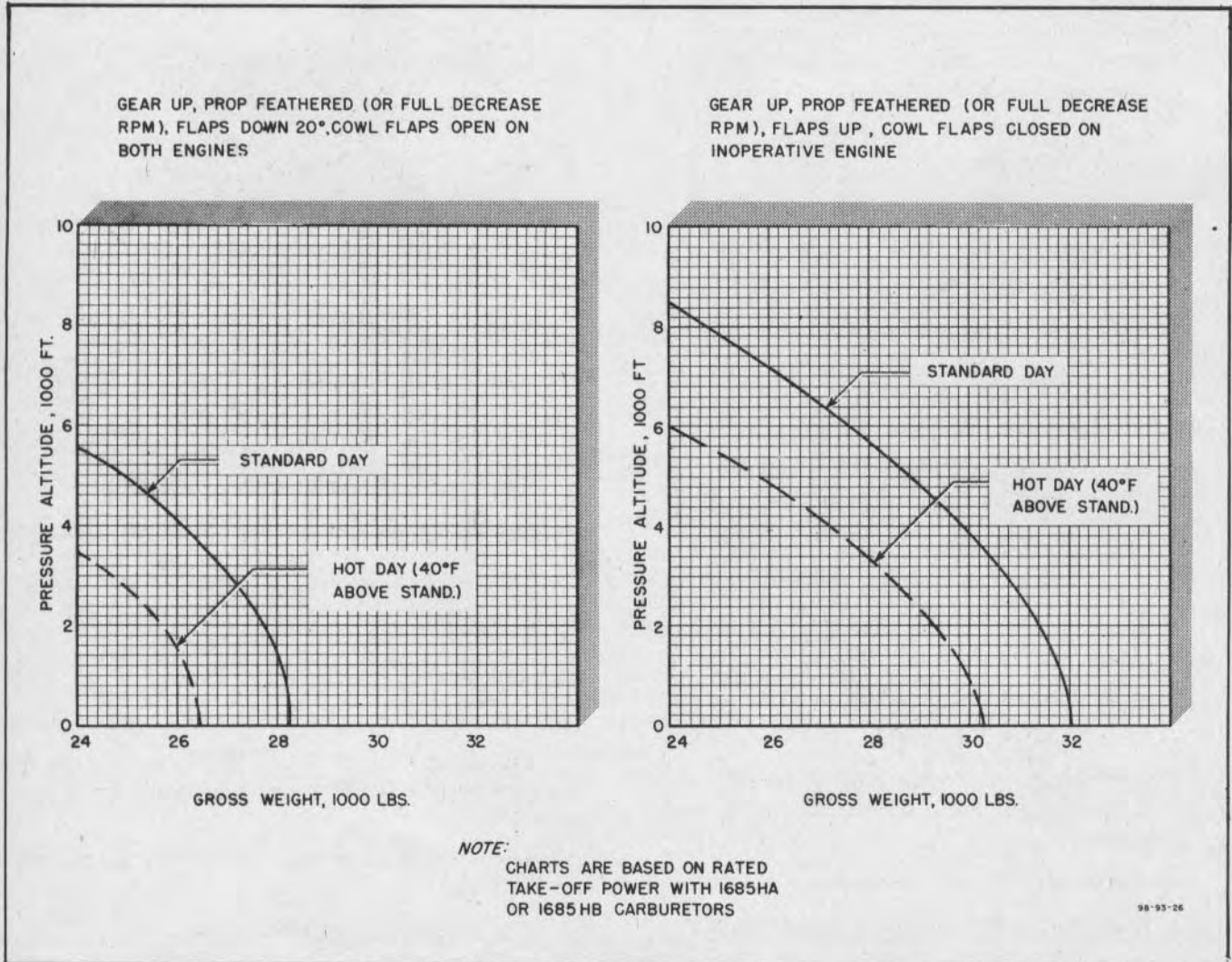
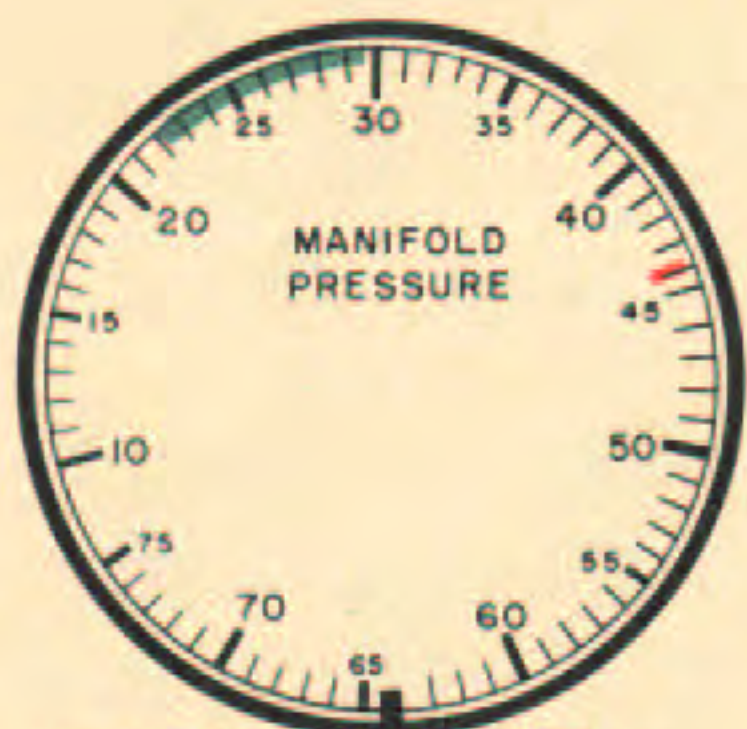

Figure 27A—Single-Engine Operation Chart (Service Ceiling vs. Gross Weight)



MAX. TAKE-OFF MANI-
FOLD PRESSURE 44.3
IN. HG.
OPERATING RANGE
22 TO 29.5 IN. HG.



MAX. TAKE-OFF 2600
RPM.
OPERATING RANGE
1600 TO 2100 RPM.

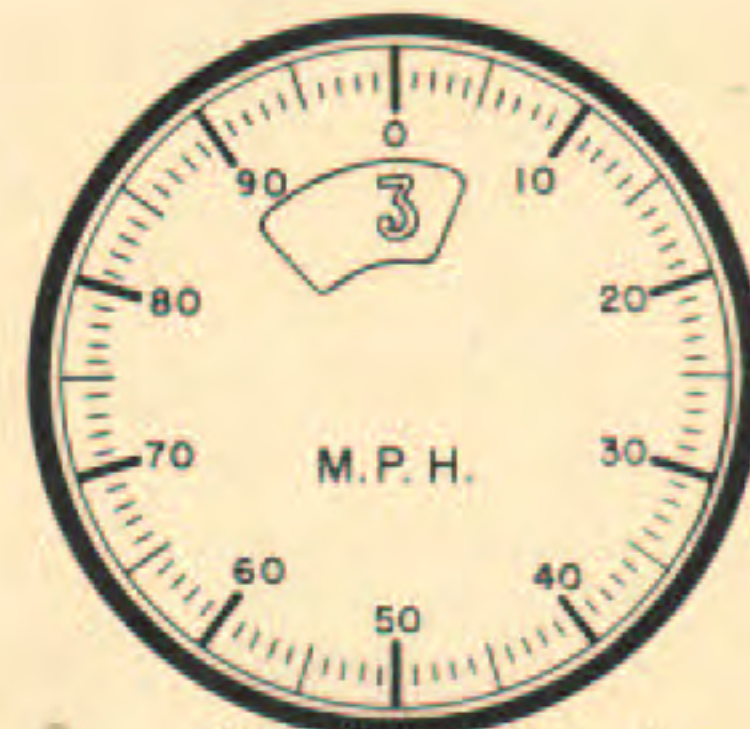

MAX. PERMISSIBLE IN-
DICATED AIRSPEED 340
M.P.H.

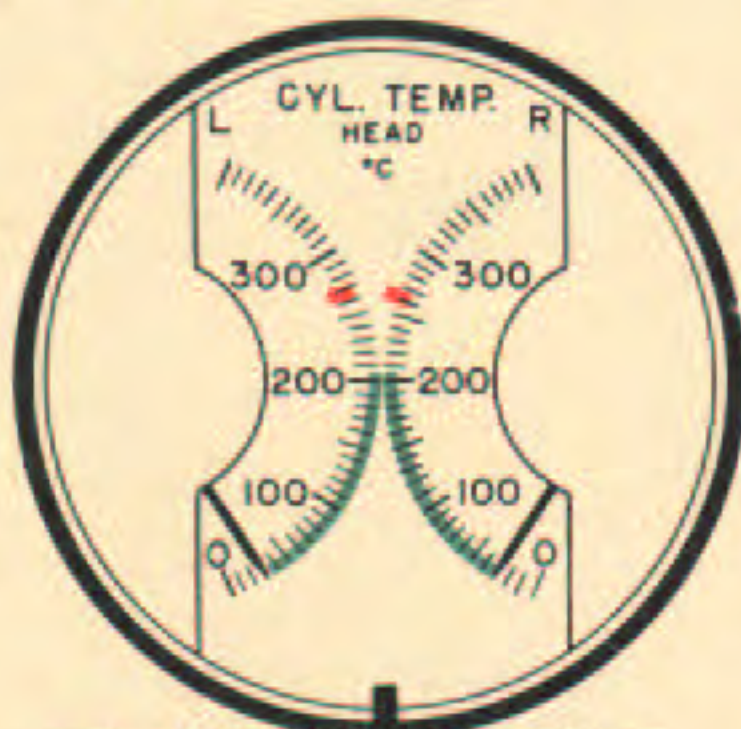

MAX. TAKE-OFF 260°C
(500°F)
OPERATING RANGE
25° TO 205°C
(77° TO 401°F)

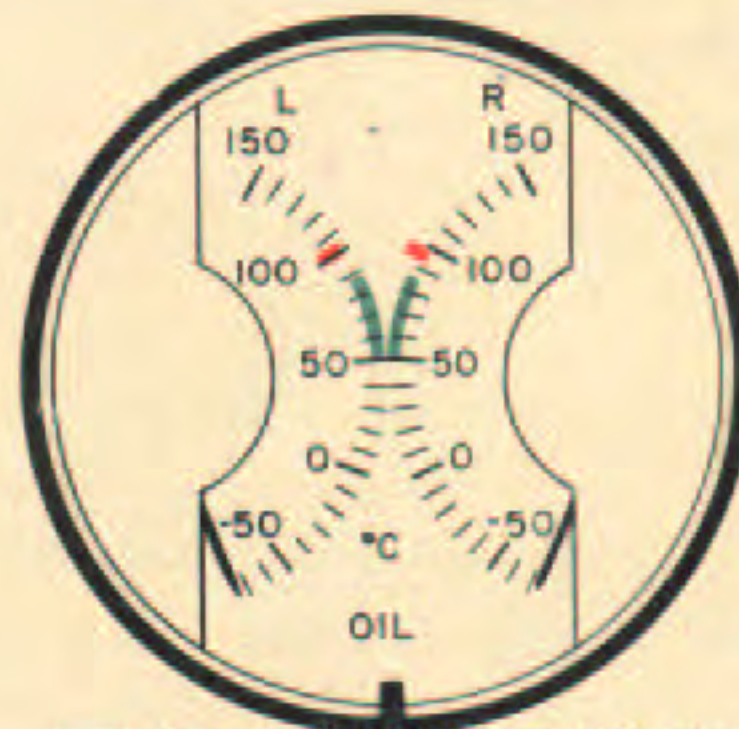

OIL TEMPERATURE OPERAT-
ING RANGE 50° TO 85°F
(122° F TO 185° F)
MAX. PERMISSIBLE OIL
TEMPERATURE 95° C
(203°F)



OIL PRESSURE OPERATING
RANGE 80 TO 85 LBS./SQ. IN.
MAX. OIL PRESSURE 90
LBS./SQ. IN.
MIN. OIL PRESSURE 75 LBS./SQ. IN.

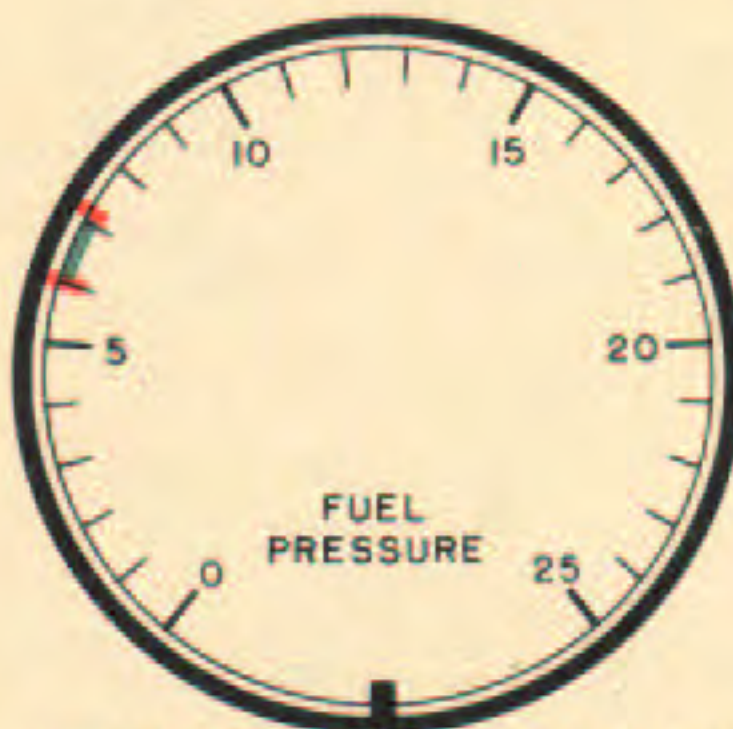

FUEL PRESSURE OPERATING
RANGE 6 TO 7 LBS./SQ. IN.
MAXIMUM FUEL PRESSURE
7 LBS./SQ. IN. MINIMUM
6 LBS./SQ. IN.

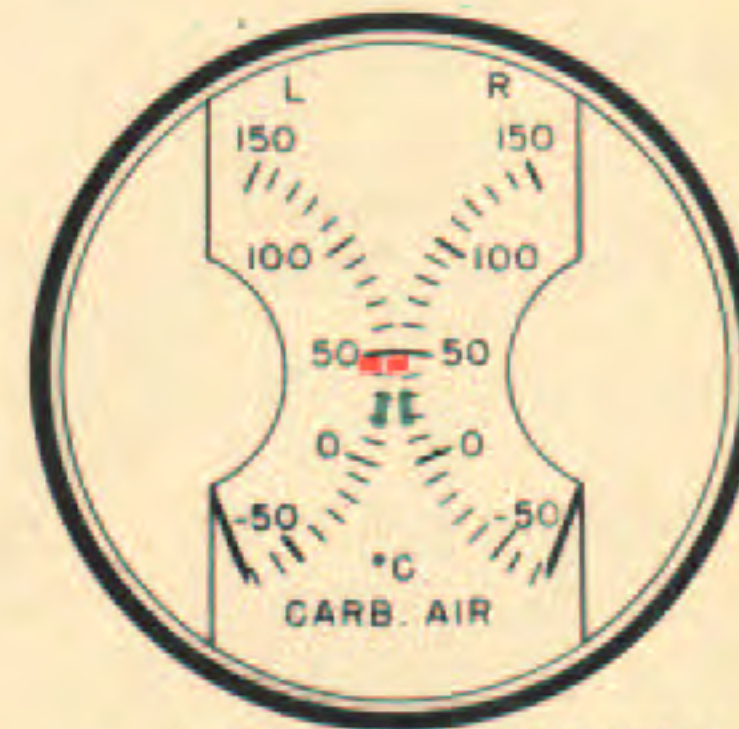

DURING ICING CONDITIONS:
DESIRABLE CARB. AIR
TEMP RANGE + 15° C
(59° F) TO + 30° C (86° F)
MAXIMUM + 40° C (104° F)

98-51-105A

Figure 28—Instrument Limitations

ing cowl flaps on inoperative engine and raising wing flaps.

(3) GROSS WEIGHT.—Climb performance decreases as the airplane gross weight increases.

Note

Figure 27A shows the effects of weight and outside air temperature on service ceiling (rate of climb 100 feet per minute). Two configurations are shown, using full take-off power in both instances. This data is approximate only.

d. If flight is to be continued after engine failure, proceed as follows:

(1) Immediately feather propeller on inoperative engine, or set it at full "DECREASE RPM." To feather the propeller, push feathering control momentarily.

(2) Place mixture control on inoperative engine in "IDLE CUT OFF."

(3) Make sure landing gear is retracted.

(4) If droppable bomb bay tank is installed, drop it to lighten load. Close bomb doors to reduce drag.

(5) Close cowl flaps on inoperative engine.

(6) Raise wing flaps slowly to prevent spilling airplane.

(7) Shut off fuel to inoperative engine, and turn "OFF" ignition and fuel booster pump switches for inoperative engine.

(8) Keep airspeed above minimum control speed.

(9) Build up flying speed and altitude until a safe landing can be made.

e. If flight is not to be continued, act quickly as follows:

(1) Depress the nose at once so that the airspeed does not drop below stalling speed.

(2) If sufficient altitude has been obtained, immediately release the droppable bomb bay tank over a suitable area, and close bomb bay doors.

(3) If there is a reasonable doubt as to the condition of the terrain on which the airplane is being forced to land, or if there is a probability of the airplane nosing over or overrunning the available landing area, retract the landing gear.

(4) Lower the wing flaps fully, if possible.

(5) Move mixture controls to "IDLE CUT OFF," and turn "OFF" ignition safety switch.

(6) Turn "OFF" battery-disconnect switches.

Note

If landing is made at night, turn on landing lights momentarily and turn "OFF" battery-disconnect switches just before striking the ground.

(7) Turn "OFF" fuel shut-off valves.

(8) Land straight ahead, only changing direction sufficiently to miss obstructions.

Note

The danger of serious injury to personnel is less if a landing is made straight ahead regardless of obstacles, rather than attempting a turn with insufficient speed and altitude in an effort to return to the field.

13. CLIMB.

a. As soon as the airplane is sufficiently clear of the ground, proceed as follows:

(1) Unlock landing gear control handle and move to "UP" position. Note landing gear position as shown by indicator on instrument panel.

(2) Raise the flaps when sufficient airspeed is attained and all obstacles are sufficiently cleared. (Raise flaps by placing control in "UP" position and then returning to neutral.)

(3) Adjust cowl flaps as required to maintain desired cylinder head temperatures.

(4) Check the cylinder head and oil temperatures and the oil pressure.

(5) Check fuel pressure. Have booster pumps "ON" below 1000 feet and above 10,000 feet. Booster pumps may be turned "ON" as required between 1000 and 10,000 feet.

(6) As the rate of climb can vary widely, depending on weight being carried and altitude, refer to the take-off, climb, and landing charts in Appendix II for the rate of climb applicable to the particular mission to be conducted.

14. DURING FLIGHT.

a. GENERAL.

(1) Set propeller and throttle controls to desired rpm and manifold pressure.

(2) Periodically check for these desired instrument readings:

Oil Pressure	80-85 lbs./sq. in. (75 lbs./sq. in. minimum, 90 lbs./sq. in. maximum)
Oil Temperature	50-70°C (122-158°F) [40°C (104°F) minimum, 85°C (185°F) maximum continuous, 95°C (203°F) maximum for 15 minutes]
Fuel Pressure	6-7 lbs./sq. in.
Cylinder Head Temperature	Military power 260°C (500°F) maximum for 5 minutes Maximum continuous power climb 260°C (500°F) maximum for 15 minutes Maximum continuous power level flight 218°C (424°F) maximum Cruising power 205°C (401°F) maximum

Voltage 28-28.5
Suction 3.75-4.25 in. Hg

(3) When altitude warrants, shift supercharger from "LOW" to "HIGH" at 1700 rpm. In prolonged flight in "HIGH" ratio, shift to "LOW" ratio at 1500 rpm or less every 2 hours for 15 minutes to remove sludge from clutch, if tactically feasible. However "HIGH" ratio should not be used continuously for more than 5 hours. Operation in "LOW" ratio may be continued as desired.

Note

In aircraft in which both engines are identified with yellow stripe around the nose section, clutches will be operated in the same manner as above, except that all shifts will be made at 1700 rpm or above. If one of the engines does not have a yellow stripe around the nose section, clutch operation on both engines will be as directed in preceding paragraph.

(4) During cruising operation with outside air temperature below -23°C (-10°F), use carburetor heat to ensure smooth engine operation.

(5) For engine operation, see Specific Engine Flight Chart, Section III, and charts in Appendix II.

b. POWER SURGE LIMITATIONS.—Carburetor metering tests have shown that the maximum power for cruising lean operation of the R-2600-29 engine with the 1685 HB carburetor is limited by power surge. The surge limits, which vary with rpm and altitude, are given in the following table:

17. STALLS.

The airplane has excellent stall characteristics. The stalls are not violent and recovery can be made simply by dropping the nose of the airplane. A slight rolling tendency is easily counteracted by the application of opposite aileron control or a slight amount of rudder. The stalling characteristics of the airplane are not affected by changes of the gross weight, the setting of the wing flaps, or the operation of the de-icer shoes. The stalling speed, however, is affected by these variables (see figure 29). The application of power tends to reduce the stalling speed further, dependent upon the amount of power used, the thrust component of which is converted into lift. A warning is given several miles per hour above the actual speed of the stall by a slight buffeting on the elevator and the horizontal stabilizer. There is no reversal of elevator force during the stall.

18. SPINS.

Recovery from spins is accomplished in the conventional manner.

19. DIVING.

The maximum indicated diving airspeed is 340 mph at normal gross weight. Recovery from dives should not be too abrupt in order to avoid placing excessive load factors on the structure. Dives and subsequent pull-outs should be tempered in accordance with the roughness of the air and the gross weight of the airplane.

**HIGHEST ALLOWABLE MANIFOLD PRESSURES AT RPM AND ALTITUDE
NOTED FOR CRUISING LEAN OPERATION**

This table is applicable to the R-2600-29 engine—1685 HB carburetor combination.

RPM	HIGH BLOWER			LOW BLOWER				
	18,000 Feet Alt.	15,000 Feet Alt.	12,000 Feet Alt.	15,000 Feet Alt.	12,000 Feet Alt.	10,000 Feet Alt.	8000 Feet Alt.	5000 Feet Alt.
2100	* 29.5"	* 29.5"	* 29.5"	21.8"	25.3"	28.3"	* 28.5"	* 28.5"
2000	28.6"	* 29.5"	* 29.5"	21.4"	24.6"	27.0"	* 28.5"	* 28.5"
1900	26.2"	28.6"	* 29.5"	21.0"	23.8"	25.8"	* 28.5"	* 28.5"
1800	22.9"	27.0"	29.7"	Not Flyable	22.8"	24.8"	28.4"	* 28.5"
1700	Not Flyable	25.9"	29.1"	Not Flyable	21.8"	24.3"	27.2"	* 28.5"
1600	Not Flyable	23.6"	28.2"	Not Flyable	20.8"	22.8"	26.2"	* 28.5"

* The manifold pressures thus marked are maximum values allowable in agreement with the specific engine flight chart, Fig. 30. All other values listed represent the maximum power obtainable as limited by power surge.

15. ENGINE FAILURE DURING FLIGHT.

For information on this subject, see Section IV, paragraph 3.

16. GENERAL FLYING CHARACTERISTICS.

The general flying characteristics of the airplane are conventional, and no special emphasis need be placed on any particular normal condition of flight. The normal accepted technique and procedure governing the flying of twin-engine bombardment aircraft should be adhered to.

20. NIGHT FLYING.

a. In flying this airplane at night, the sequence outlined for daylight operation should be even more strictly observed. In addition, the pilot and crew members should familiarize themselves with the location of the different lights and their control switches.

(1) INSTRUMENT LIGHTING.—Turn on the fluorescent lamps by turning the rheostat knobs (on the side of each control column) to "START" until the light comes on; then switch to "ON" or "DIM" position. Rotating

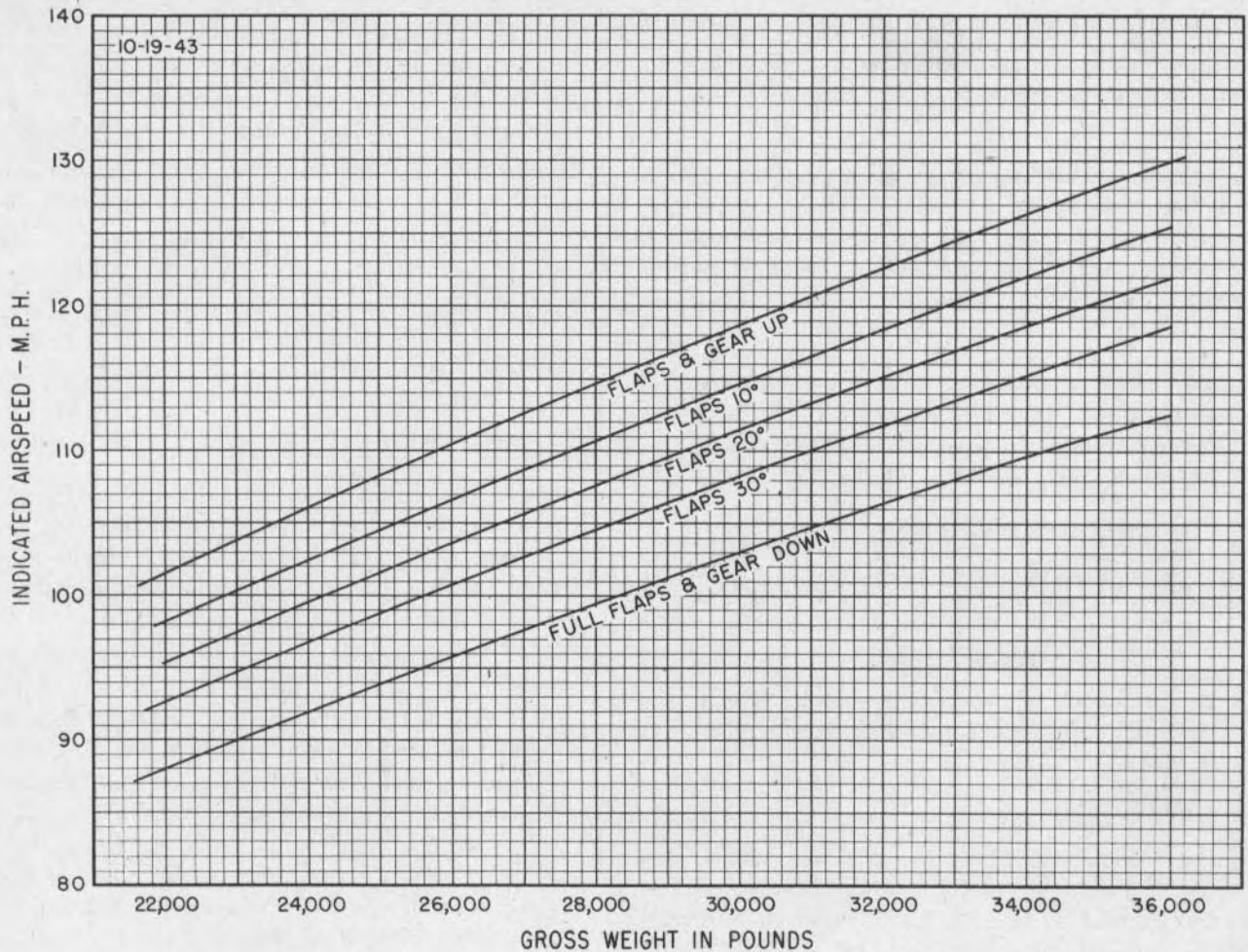

108-93-81

Figure 29—Stalling Speed Chart

the lens housing selects the visible or invisible illumination for the instruments.

(2) **COCKPIT EXTENSION LIGHT.**—An extension light with a six-foot cord is mounted on the right-hand instrument subpanel for use when a small amount of light is desired.

(3) **POSITION LIGHTS.**—The position light switches are on the pilot's switch panel (see figure 20). Two intensities of light are available: "BRIGHT" and "DIM."

(4) **LANDING LIGHTS.**—Switches for the landing lights are located on the control pedestal switch panel. For operation, see paragraph 3. b. (4).

(5) **RECOGNITION LIGHTS.**—Set the switches, located on the control pedestal switch panel, for the light or combination of lights desired. Place the switches in "STEADY" position for continuous operation and in "KEY" position for intermittent operation by means of the keying

switch located directly above the bank of four recognition light switches.

21. APPROACH AND LANDING.

a. **APPROACH.**—When the airplane approaches the field, this sequence of operations should be followed:

- (1) De-icer control "OFF."
- (2) Turrets pointing directly aft; waist guns stowed.
- (3) Emergency ground escape hatches unlocked.
- (4) Fuel booster pumps "ON."
- (5) General hydraulic pressure 800-1100 lbs./sq.in.
- (6) Brake pressure 1000-1200 lbs./sq.in.
- (7) Set propeller controls at 2100 rpm.
- (8) Set mixture controls at "FULL RICH" (lock snug).
- (9) Set supercharger controls in "LOW" (lock).
- (10) Close cowl flaps (controls neutral).

(11) When outside air temperature is below -23°C (-10°F), use carburetor heat to ensure smooth engine operation.

(12) Lower landing gear to down position and lock. Do not lower gear above 170 mph. Check position of gear by indicator and warning light. On late airplanes, a warning horn will sound when the throttle is retarded if the gear is not down and locked.

Note

An inspection hole is provided on the right side of the crawl tunnel just aft of the bombardier's compartment for the purpose of checking visually that the nose gear is down and locked.

(13) Master cabin heat switch "OFF."

(14) Lower wing flaps. Leave handle in "DOWN" position.

WARNING

Do not exceed 170 mph with flaps down. If landing is not made, raise flaps slowly after sufficient altitude and speed are obtained.

b. LANDING.

(1) Having turned into the field and lowered the flaps, maintain a correct gliding speed. Adjust the elevator trim tabs to assist in landing. Having slowed down after landing, raise the flaps and turn "OFF" the fuel booster pumps. Open cowl flaps before taxiing.

(2) Move propeller controls to full "INCREASE RPM."

(3) Make a normal landing in mud or sand, hold the airplane straight by use of the rudder with minimum use of the brakes. This action minimizes the possibility of skidding, which may occur on a slick surface.

22. STOPPING ENGINES.

a. To stop engines, proceed as follows:

(1) Set propeller controls at full "INCREASE RPM."

(2) Prior to stopping the engines after the last flight of the day, run the engines at a speed of 800 to 1000 rpm and shift the supercharger controls from "LOW" to "HIGH" at 30-second intervals for a period of 5 minutes. This procedure serves to wash out any sludge which may have accumulated in the supercharger clutches. Lock the supercharger controls in "LOW."

(3) Idle at 800-1000 rpm to cool engines.

(4) When a cold weather start is anticipated, dilute the engines at 1000 rpm for the time indicated below, consistent with the lowest expected air temperature.

TEMPERATURE °C	TIME—MINUTES	MAX. ALLOW. CYL. HEAD	TEMP. °C OIL
-6 to -18 (+20° to 0°F)	3	150	50
-18 to -29 (0° to -20°F)	5	145	45
-29 to -40 (-20° to -40°F)	7	140	40
-40 to -51 (-40° to -60°F)	11	140	40

At the completion of the above dilution period, run both engines up to 1500 rpm, continuing dilution, and operate each propeller governor through three complete cycles. Release dilution switch and decrease engine speed. Stop engines and install engine covers.

Note

If temperatures approach limits during 1000 rpm dilution, shut down for 10-15 minutes to cool engine; then start engine and finish dilution procedure.

(5) Run engines at 1200 rpm for not more than 30 seconds to permit efficient scavenging of crankcase oil; then move mixture controls to "IDLE CUT OFF." Do not move mixture controls from "IDLE CUT OFF."

23. BEFORE LEAVING PILOT'S COMPARTMENT.

a. After engines stop, proceed as follows:

(1) Turn "OFF" all switches.

(2) Set parking brakes.

WARNING

Do not set parking brakes while they are hot.

(3) Fasten landing gear control lock.

(4) Lock flying controls.

(5) When engine is sufficiently cool, close cowl flaps.

(6) On early airplanes only, place carburetor air controls in "ICING" position.

(7) If airplane is not to be serviced by ground crew, close all entrance hatches upon leaving airplane. Leave emergency escape hatch lock springs in open position.



SECTION III
FLIGHT OPERATING DATA

1. POWER PLANT CHART.

a. Operating limitations and characteristics of the R-2600-13 or R-2600-29 engine, with which this airplane is powered, are summarized for ready reference on the Power Plant Charts. (See figures 30, 30A, 30B, and 30C.) Flight operating personnel should be familiar with and observe this information.

b. Engine power rating shown on the charts are defined as follows:

(1) TAKE-OFF.—Maximum recommended for take-off under the specified time limit of five minutes.

(2) WAR EMERGENCY.—Maximum allowed for emergency operation during combat for a period not exceeding five minutes in duration.

(3) MILITARY POWER.—Maximum recommended for operation for periods not exceeding five minutes in duration.

(4) NORMAL RATED.—Maximum recommended for unlimited operation with rich mixture in climb and level flight.

(5) MAXIMUM CRUISE.—Maximum recommended for operation with lean mixture.

2. AIRSPEED CORRECTION CHART.

CALIBRATED AIRSPEED—MPH	INDICATED IAS	ALTIMETER ERROR (FEET) (ADD TO ALTIMETER READING)	
		S.L.	15,000
100	99	20	30
120	118	25	40
140	137	30	50
160	156	40	65
180	176	50	80
200	195	65	100
220	214	80	130
240	234	100	160
260	253	125	200
280	272	150	250
300	291	180	290

3. LOAD AND BALANCE.

A load adjuster with carrying case and a Weight and Balance Data Handbook (AN 01-1-40) are furnished with each airplane. The load adjuster, which is similar to a slide rule, is used to check the load and balance from basic airplane to loaded airplane to ensure that the weight distribution of all items loaded will not produce an unsafe balance condition. The airplane model designation stamped on every load adjuster indicates that the instrument may be used for balance calculations on any airplane of that particular model. However, the *index figure* entered in the carrying case identification card, or on Chart C of the Handbook, is correct only for the airplane whose serial number is printed on the card or Handbook, and represents the balance moment of only that one particular basic airplane.

RESTRICTED
AN 01-60GE-1

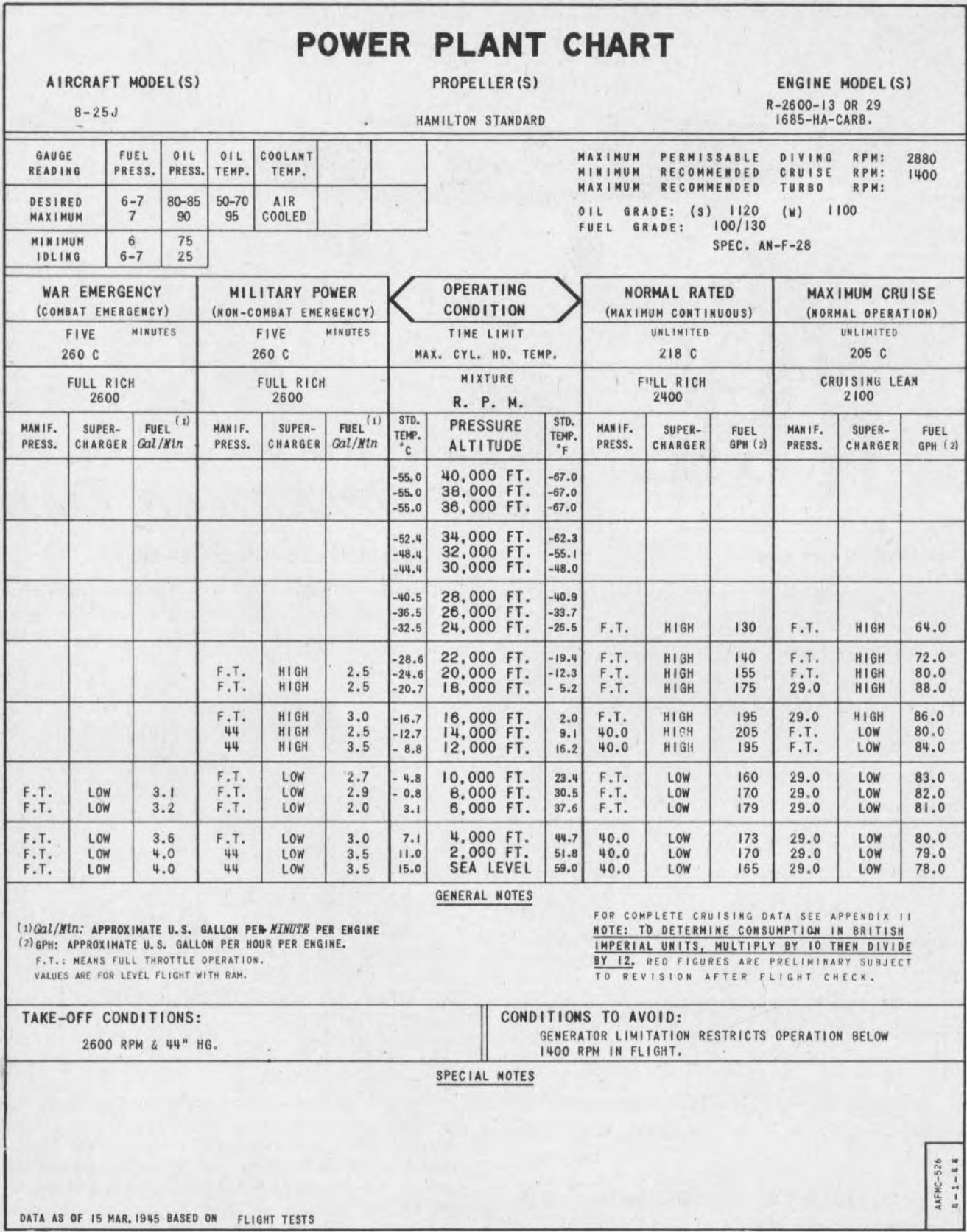

Figure 30—Power Plant Chart—1685-HA Carburetor

POWER PLANT CHART														
AIRCRAFT MODEL (S) B-25J				PROPELLER (S) HAMILTON STANDARD				ENGINE MODEL (S) R-2600-13-OR -29. 1685-HB-CARB.						
GAUGE READING	FUEL PRESS.	OIL PRESS.	OIL TEMP.	COOLANT TEMP.			MAXIMUM PERMISSIBLE DIVING RPM: 2880 MINIMUM RECOMMENDED CRUISE RPM: 1400 MAXIMUM RECOMMENDED TURBO RPM: OIL GRADE: (S) 1120 (W) 1100 FUEL GRADE: 100/120 SPEC. AN-F-28							
DESIRED MAXIMUM	6-7 7	80-85 90	50-70 95	AIR COOLED										
MINIMUM IDLING	6 6-7	75 25												
WAR EMERGENCY (COMBAT EMERGENCY)			MILITARY POWER (NON-COMBAT EMERGENCY)			OPERATING CONDITION		NORMAL RATED (MAXIMUM CONTINUOUS)			MAXIMUM CRUISE (NORMAL OPERATION)			
5 MINUTES 260 C			5 MINUTES 260 C			TIME LIMIT MAX. CYL. HD. TEMP.		UNLIMITED 218 C			UNLIMITED 205 C			
FULL RICH 2600			FULL RICH 2600			MIXTURE R. P. M.		FULL RICH 2400			CRUISING LEAN 2100			
MANIF. PRESS.	SUPER-CHARGER	FUEL ⁽¹⁾ Gal/Mtn	MANIF. PRESS.	SUPER-CHARGER	FUEL ⁽¹⁾ Gal/Mtn	STD. TEMP. °C	PRESSURE ALTITUDE	STD. TEMP. °F	MANIF. PRESS.	SUPER-CHARGER	FUEL GPH ⁽²⁾	MANIF. PRESS.	SUPER-CHARGER	FUEL GPH ⁽²⁾
						-55.0 -55.0 -55.0	40,000 FT. 38,000 FT. 36,000 FT.	-67.0 -67.0 -67.0						
						-52.4 -48.4 -44.4	34,000 FT. 32,000 FT. 30,000 FT.	-62.3 -55.1 -48.0						
						-40.5 -36.5 -32.5	28,000 FT. 26,000 FT. 24,000 FT.	-40.9 -33.7 -26.5	F.T.	HIGH	100	F.T.	HIGH	72.0
			F.T. F.T.	HIGH HIGH	2.5 3.0	-28.6 -24.6 -20.7	22,000 FT. 20,000 FT. 18,000 FT.	-19.4 -12.3 -5.2	F.T. F.T. F.T.	HIGH HIGH HIGH	110 125 145	F.T. 29.0 29.0	HIGH HIGH HIGH	78.0 84.0 83.0
			F.T. 44 44	HIGH HIGH HIGH	3.0 3.5 3.5	-16.7 -12.7 -8.8	16,000 FT. 14,000 FT. 12,000 FT.	2.0 9.1 16.2	F.T. 40.0 40.0	HIGH HIGH HIGH	162 182 178	29.0 F.T. F.T.	HIGH LOW LOW	82.0 69.0 75.0
F.T. F.T.	LOW LOW	3.1 3.2	F.T. F.T. F.T.	LOW LOW LOW	2.5 3.0 3.0	-4.8 -0.8 3.1	10,000 FT. 8,000 FT. 6,000 FT.	23.4 30.5 37.6	F.T. F.T. F.T.	LOW LOW LOW	155 173 184	29.0 29.0 29.0	LOW LOW LOW	83.0 82.0 81.0
F.T. F.T. F.T.	LOW LOW LOW	3.6 4.0 4.0	F.T. 44 44	LOW LOW LOW	3.0 3.5 3.5	7.1 11.0 15.0	4,000 FT. 2,000 FT. SEA LEVEL	44.7 51.8 59.0	40.0 40.0 40.0	LOW LOW LOW	180 175 170	29.0 29.0 29.0	LOW LOW LOW	80.0 79.0 78.0
GENERAL NOTES														
(1) Gal/Mtn: APPROXIMATE U.S. GALLON PER MINUTE PER ENGINE (2) GPH: APPROXIMATE U.S. GALLON PER HOUR PER ENGINE. F.T.: MEANS FULL THROTTLE OPERATION. VALUES ARE FOR LEVEL FLIGHT WITH RAM.								FOR COMPLETE CRUISING DATA SEE APPENDIX II NOTE: TO DETERMINE CONSUMPTION IN BRITISH IMPERIAL UNITS, MULTIPLY BY 10 THEN DIVIDE BY 12. RED FIGURES ARE PRELIMINARY SUBJECT TO REVISION AFTER FLIGHT CHECK.						
TAKE-OFF CONDITIONS: 2600 RPM 44 in Hg.							CONDITIONS TO AVOID: 1 GENERATOR LIMITATION RESTRICTS OPERATIONS BELOW 1400 RPM IN FLIGHT							
SPECIAL NOTES														
DATA AS OF 15 MAR. 1945 BASED ON FLIGHT TESTS														

Figure 30A—Power Plant Chart—1685-HB Carburetor

POWER PLANT CHART FOR USE WITH GRADE 91 FUEL ONLY

AIRCRAFT MODEL (S)
B-25J

PROPELLER (S)
HAMILTON STANDARD

ENGINE MODEL (S)
R-2600-13 OR -29
1685-HA-CARB.

TAKE OFF			NORMAL RATED			OPERATING CONDITION			MAXIMUM CRUISE			DESIRED CRUISE		
FIVE MINUTES 260 C			UNLIMITED 218 C			TIME LIMIT MAX. CYL. HD. TEMP.			UNLIMITED 205 C			UNLIMITED 205 C		
FULL RICH 2600			FULL RICH 2400			MIXTURE R. P. M.			FULL RICH 2100			CRUISING LEAN 1600		
MANIF. PRESS.	SUPER- CHARGER	FUEL ⁽¹⁾ Gal/Mtn	MANIF. PRESS.	SUPER- CHARGER	FUEL ⁽²⁾ GPH	STD. TEMP. °C	PRESSURE ALTITUDE	STD. TEMP. °F	MANIF. PRESS.	SUPER- CHARGER	FUEL ⁽²⁾ GPH	MANIF. PRESS.	SUPER- CHARGER	FUEL ⁽²⁾ GPH
						-55.0	40,000 FT.	-67.0						
						-55.0	38,000 FT.	-67.0						
						-55.0	36,000 FT.	-67.0						
						-52.4	34,000 FT.	-62.3						
						-48.4	32,000 FT.	-55.1						
						-44.4	30,000 FT.	-48.0						
						-40.5	28,000 FT.	-40.9						
						-36.5	26,000 FT.	-33.7						
						-32.5	24,000 FT.	-26.5						
						-28.6	22,000 FT.	-19.4						
						-24.6	20,000 FT.	-12.3						
						-20.7	18,000 FT.	-5.2						
			F. T.	LOW	120	-16.7	16,000 FT.	2.0	F. T.	LOW	85	F. T.	LOW	52
			F. T.	LOW	135	-12.7	14,000 FT.	9.1	F. T.	LOW	95	F. T.	LOW	55
			F. T.	LOW	140	-8.8	12,000 FT.	16.2	F. T.	LOW	100	F. T.	LOW	55
F. T.	LOW	2.5	F. T.	LOW	140	-4.8	10,000 FT.	23.4	29	LOW	95	F. T.	LOW	51
F. T.	LOW	3.0	34	LOW	140	-0.8	8,000 FT.	30.5	29	LOW	90	26	LOW	50
			34	LOW	135	3.1	6,000 FT.	37.6	29	LOW	87	26	LOW	48
39.5	LOW	3.0	34	LOW	130	7.1	4,000 FT.	44.7	29	LOW	83	26	LOW	47
39.5	LOW	3.0	34	LOW	125	11.0	2,000 FT.	51.8	29	LOW	79	26	LOW	45
39.5	LOW	3.0	34	LOW	120	15.0	SEA LEVEL	59.0	29	LOW	75	26	LOW	43

GENERAL NOTES

⁽¹⁾Gal/Mtn: APPROXIMATE U.S. GALLON PER MINUTE PER ENGINE
⁽²⁾GPH: APPROXIMATE U.S. GALLON PER HOUR PER ENGINE.
 F. T.: MEANS FULL THROTTLE OPERATION.
 VALUES ARE FOR LEVEL FLIGHT WITH RAM.

NOTE: TO DETERMINE CONSUMPTION IN BRITISH
 IMPERIAL UNITS, MULTIPLY BY 10 THEN DIVIDE
 BY 12. RED FIGURES ARE PRELIMINARY SUBJECT
 TO REVISION AFTER FLIGHT CHECK.

TAKE-OFF CONDITIONS:

2600 RPM 39.5° HG.

CONDITIONS TO AVOID:

1. OPERATION IN HIGH BLOWER
2. GENERATOR LIMITATIONS RESTRICTS OPERATION BELOW 1400 RPM IN FLIGHT.

SPECIAL NOTES

DATA AS OF 15MAR.45 BASED ON FLIGHT TESTS

Figure 30B—Power Plant Chart—Grade 91 Fuel—1685HA Carburetor

POWER PLANT CHART FOR USE WITH GRADE 91 FUEL ONLY

AIRCRAFT MODEL (S)
B-25J

PROPELLER (S)
HAMILTON STANDARD

ENGINE MODEL (S)
R-2600-29
1685-HB-CAR3.

TAKE OFF			NORMAL RATED			OPERATING CONDITION			MAXIMUM CRUISE			DESIRED CRUISE		
FIVE MINUTES 260 C			UNLIMITED 218 C			TIME LIMIT MAX. CYL. HD. TEMP.			UNLIMITED 205 C			UNLIMITED 205 C		
FULL RICH 2600			FULL RICH 2400			MIXTURE R. P. M.			FULL RICH 2100			CRUISING LEAN 1600		
MANIF. PRESS.	SUPER-CHARGER	FUEL ⁽¹⁾ Gal/Mtn	MANIF. PRESS.	SUPER-CHARGER	FUEL ⁽²⁾ GPH	STD. TEMP. °C	PRESSURE ALTITUDE	STD. TEMP. °F	MANIF. PRESS.	SUPER-CHARGER	FUEL ⁽²⁾ GPH	MANIF. PRESS.	SUPER-CHARGER	FUEL ⁽²⁾ GPH
						-55.0	40,000 FT.	-67.0						
						-55.0	38,000 FT.	-67.0						
						-55.0	36,000 FT.	-67.0						
						-52.4	34,000 FT.	-62.3						
						-48.4	32,000 FT.	-55.1						
						-44.4	30,000 FT.	-48.0						
						-40.5	28,000 FT.	-40.9						
						-36.5	26,000 FT.	-33.7						
						-32.5	24,000 FT.	-26.5						
						-28.6	22,000 FT.	-19.4						
						-24.6	20,000 FT.	-12.3						
						-20.7	18,000 FT.	-5.2						
			F. T.	LOW	107	-16.7	16,000 FT.	2.0	F. T.	LOW	85	F. T.	LOW	47
			F. T.	LOW	117	-12.7	14,000 FT.	9.1	F. T.	LOW	92	F. T.	LOW	50
			F. T.	LOW	133	-8.8	12,000 FT.	16.2	F. T.	LOW	100	F. T.	LOW	50
F. T.	LOW	2.5	F. T.	LOW	148	-4.8	10,000 FT.	23.4	29	LOW	98	F. T.	LOW	53
F. T.	LOW	3.0	34	LOW	146	-0.8	8,000 FT.	30.5	29	LOW	95	26	LOW	52
			34	LOW	142	3.1	6,000 FT.	37.5	29	LOW	92	26	LOW	50
39.5	LOW	3.0	34	LOW	138	7.1	4,000 FT.	44.7	29	LOW	89	26	LOW	48
39.5	LOW	3.0	34	LOW	134	11.0	2,000 FT.	51.8	29	LOW	86	26	LOW	46
39.5	LOW	3.0	34	LOW	130	15.0	SEA LEVEL	59.0	29	LOW	83	26	LOW	44

GENERAL NOTES

⁽¹⁾Gal/Mtn: APPROXIMATE U.S. GALLON PER MINUTE PER ENGINE
⁽²⁾GPH: APPROXIMATE U.S. GALLON PER HOUR PER ENGINE.
 F. T. : MEANS FULL THROTTLE OPERATION.
 VALUES ARE FOR LEVEL FLIGHT WITH RAM.

NOTE: TO DETERMINE CONSUMPTION IN BRITISH IMPERIAL UNITS, MULTIPLY BY 10 THEN DIVIDE BY 12. RED FIGURES ARE PRELIMINARY SUBJECT TO REVISION AFTER FLIGHT CHECK.

TAKE-OFF CONDITIONS:

2600 RPM 39.5" HG.

CONDITIONS TO AVOID:

1. OPERATION IN HIGH BLOWER
2. GENERATOR LIMITATIONS RESTRICTS OPERATION BELOW 1400 RPM IN FLIGHT.

SPECIAL NOTES

DATA AS OF 15 MAR 45 BASED ON FLIGHT TESTS

Figure 30C—Power Plant Chart—Grade 91 Fuel—1685HB Carburetor

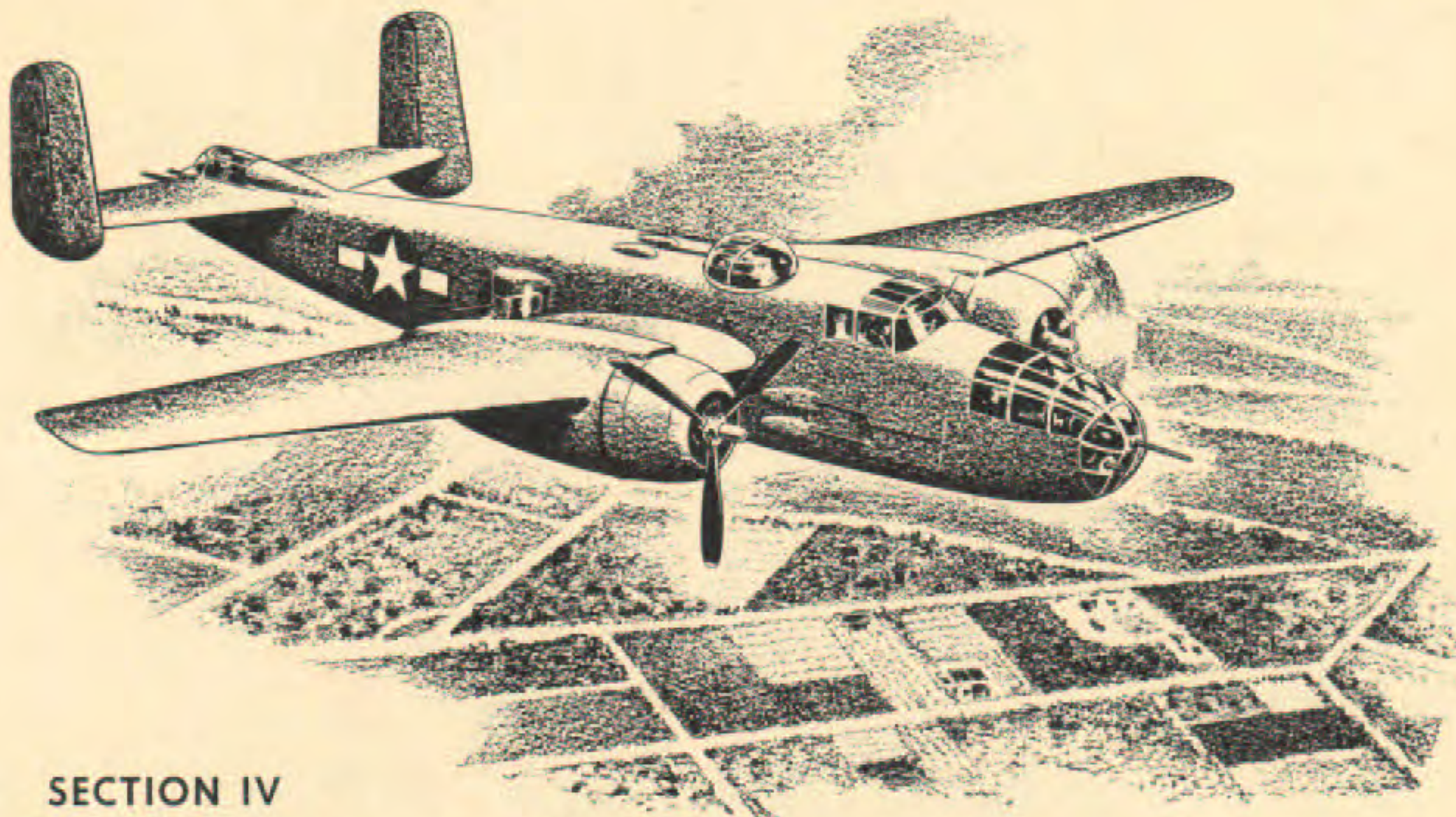

SECTION IV
EMERGENCY OPERATING INSTRUCTIONS

1. GENERAL.

All emergency instructions have been assembled in this Section to facilitate quick reference by the flight crew, who should thoroughly acquaint themselves with the following information before their first flight in this airplane. Ground drills in emergency operations, exiting from airplane, and ditching are highly recommended.

2. EMERGENCY EXITS ON GROUND.

In addition to the forward and aft hatches, an emergency exit from the airplane may be made through the center section of the cockpit hood, through the two cockpit side window sliding panels, the bombardier's escape hatch, the hatch on the right side of the fuselage opposite the aft hatch, or the transparent hood of the tail gunner's station. (See figure 31.)

3. ENGINE FAILURE DURING FLIGHT.

a. SINGLE-ENGINE FAILURE.—If only one engine fails, refer to the single-engine cruising charts in Appendix II and follow these instructions:

Note

The flying characteristics of this airplane with single-engine failure are exceptionally good and the airplane need not be abandoned unless the fuel is depleted. For maximum range conditions, fly at the lowest possible altitude and use the engine operating conditions as shown on the charts.

(1) Feather the propeller on the dead engine immediately. To feather the propeller, push propeller feathering control momentarily. To unfeather, set propeller control in "DECREASE RPM"; push feathering control and release at 800 rpm.

Note

In practice feathering while flying, the period of time the propeller is left in the feathered position should not exceed 15 minutes.

(2) Close cowl flaps fully.

(3) Shut off the fuel to the dead engine. The shut-off valves may be controlled from either the handles to the

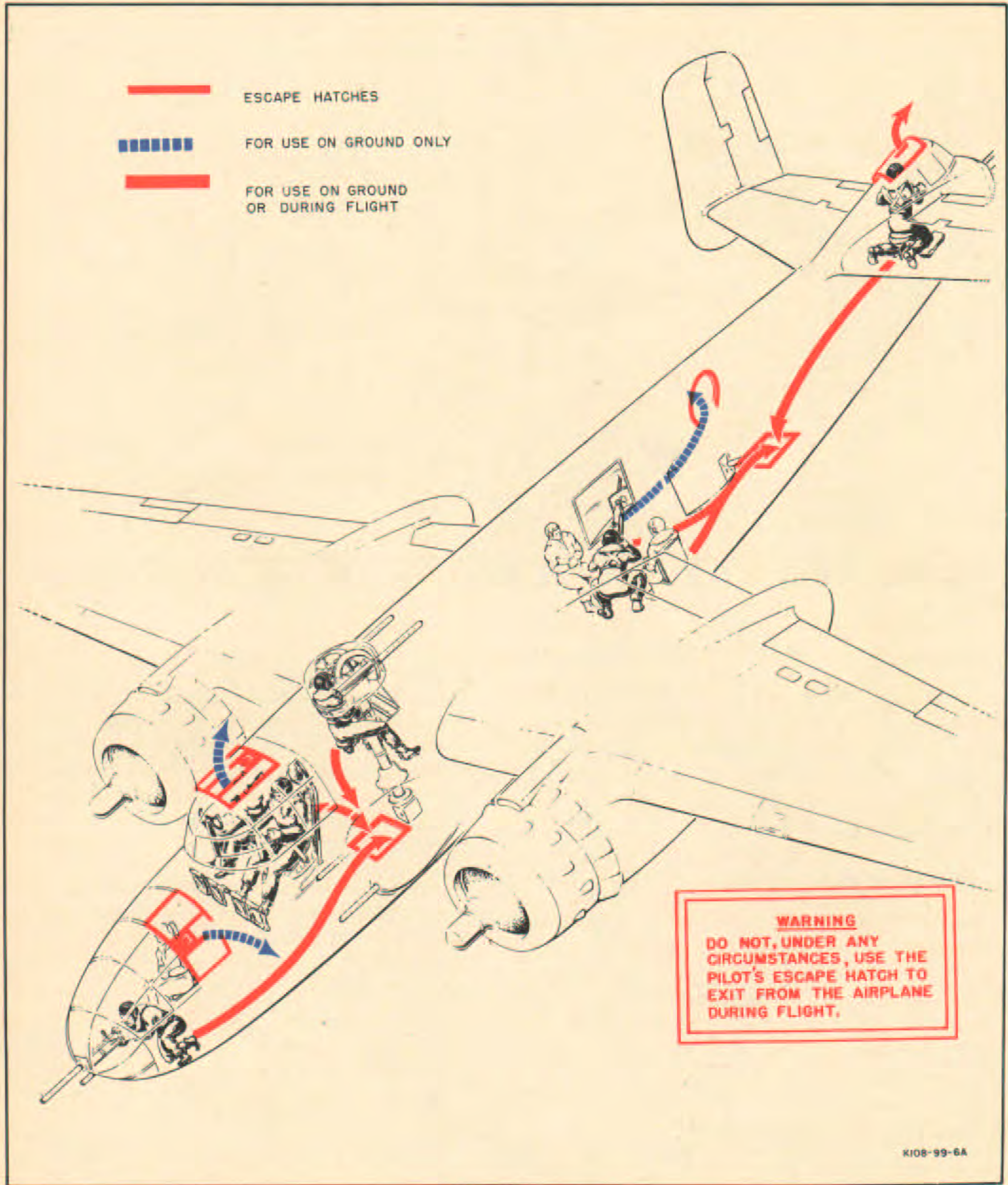

Figure 31—Emergency Exits

left of the pilot's seat or the controls on the shelf in the aft end of the upper turret compartment.

(4) All electrical equipment not necessarily required for flight should be turned "OFF" to prevent excessive current drain on the remaining generator.

(5) The airplane may be easily trimmed to fly hands off with one engine inoperative.

(6) When landing, the live engine should be in full "INCREASE RPM," in case full power is needed.

(7) In the single-engine approach to a landing, gradually reduce the power and trim the rudders accordingly to prevent sudden yaw. During the approach, maintain sufficient power to control the airplane and do not lower flaps fully until safe landing is assured. It must be remembered that after the glide is started, with subsequent lowering of airspeed, level flight cannot be resumed until the airplane has been dived to regain the airspeed lost.

Note

The pilot should practice single-engine operation.

b. TWO-ENGINE FAILURE.—With two-engine failure, the airplane may be abandoned, ditched, or brought in for a dead-stick landing, as the case requires. However, it should be kept in mind that the dead-stick landing qualities of this airplane are very good. For a landing with both engines dead, follow these instructions:

(1) Depress the nose of the airplane to remain above stalling speed.

(2) Turn "OFF" the ignition safety switch.

(3) If it is necessary to stretch the glide, feather both propellers. Windmilling propellers help for short landings.

(4) Shut off the fuel to both engines.

(5) **Salvo** bomb bay tank, if installed, and if sufficient altitude has been attained. If available, use hydraulic pressure to open and close the bomb bay doors; otherwise, order turret operator to crank the doors by the mechanical linkage.

(6) Lower the flaps to desired position by use of hydraulic hand-pump if system is intact. If the hydraulic system has failed, order the waist gunner to lower the flaps by use of the handcrank.

(7) Do not lower the landing gear. There is less chance of injury to the crew if the airplane is landed on its belly.

(8) Turn "OFF" battery-disconnect switches just before landing.

(9) Land into the wind in normal landing attitude, only changing direction sufficiently to avoid obstructions.

4. EMERGENCY EXITS DURING FLIGHT.

During flight, emergency egress should be made through the hatch in the upper turret compartment, the aft hatch, or the tail gunner's emergency exit. (See figure 31.) The airplane should be abandoned upon command of the pilot over the interphone or by a prearranged signal of the warning horns.

WARNING

Do not use pilot's escape hatch in flight—
for ground use only.

5. DITCHING.

a. GENERAL.—These instructions are for the general guidance of all members of the crew in the event of a forced landing at sea, which is called "Ditching." In these instructions, the life raft is referred to as the "Dinghy."

IMPORTANT

It is imperative that ditching drills be practiced frequently, and that a suitable ditching station be assigned each crew member.

b. AVOIDING DITCHING.—Many ditchings could have been avoided by proper operation of the airplane and a thorough knowledge of its operating characteristics under all circumstances. The pilot should be thoroughly familiar with the Flight Operation Charts in Appendix II of this Handbook. The pilot should know the proper method of flying this airplane in event of a single-engine failure (see paragraph 3), and he should fully understand the operation and limitations of the fuel system, particularly those controls which are used to transfer fuel from one tank to another or to shut off the fuel supply to an engine. The pilot should be practiced in flying the airplane at different weights at heights above 3000 feet, with one engine inoperative. It is extremely important that the pilot know the best speed and altitude for maintaining flight at reduced power under various kinds of circumstances.

c. LIGHTENING THE LOAD.—If height cannot be maintained above a reasonable altitude because of failure of one engine, icing conditions, or other circumstances, lighten the load of the airplane by jettisoning these items:

(1) The bomb load or torpedo.

(2) The bomb bay droppable fuel tank, if not required in the attempt to reach a friendly base.

(3) Waist guns and ammunition, if not liable to attack.

(4) Camera and other equipment not essential to the navigation of the airplane.

d. PREPARATION FOR DITCHING.—If the pilot is certain he cannot reach land, preparation for ditching must begin immediately.

(1) THE SIGNAL.—The pilot must command the crew by interphone to prepare for ditching. There should also be a prearranged signal, such as the letter "D" repeated three times. In addition, the warning horn system may be used as a signal. Each member of the crew must acknowledge the command of the pilot by the answer "Waist gunner ditching," "Tail gunner ditching," etc., and should then move to his ditching station so the pilot can adjust trim and lower the flaps.

(2) PILOT'S DUTIES.—The pilot coordinates the work of the crew, and makes certain they are carrying out the proper ditching procedure. In addition, the pilot must perform these tasks:

(*a*) Destroy confidential equipment by pushing both detonator buttons simultaneously.

(*b*) Destroy secret papers.

(*c*) Be sure bombs, torpedo, or ferrying tank has been dropped and bomb doors are closed. However, if there is not sufficient time to accomplish this, keep the doors closed and check the bomb controls at "SAFE." This is absolutely essential.

(*d*) Release pilot's escape hatch. This must be done to prevent hatch from being jammed upon impact.

(*e*) Check landing gear up.

(*f*) Switch on landing lights, if darkness or hazy weather makes this necessary, provided the lights do not cause reflections which disturb vision.

Note

Although the surface of the water may be seen in the beam of the landing lights, judgment of height under these conditions may not be correct.

(3) COPILOT-NAVIGATOR'S DUTIES.—The navigator should have a constant knowledge of wind speed, direction, drift, and fixed position of the airplane. He should always know the fuel consumption in relation to his estimated time of arrival. At the pilot's command, the navigator will:

(*a*) Calculate position of airplane.

(*b*) Advise pilot of position, course, and speed maintained.

(*c*) Advise pilot of estimated position of ditching.

(*d*) Inform pilot of surface wind and direction.

(*e*) Destroy secret papers and place charts with latest position marked on them, in satchel.

(4) CREW DUTIES.—Upon the pilot's order to prepare for ditching, each crew member shall acknowledge the order, remove his parachute, and then proceed as follows:

(*a*) UPPER TURRET GUNNER.—Make certain the cover hatch is securely closed, and then go to ditching station.

(*b*) BOMBARDIER.—Proceed immediately to ditching station.

(*c*) TAIL GUNNER.—If not needed for combat, and if there is sufficient altitude, release escape hatch and go forward to assist waist gunner.

(*d*) RADIO OPERATOR—WAIST GUNNER (AIDED BY TAIL GUNNER).

1. In accordance with the situation, the radio operator should use one of the three priority calls: S.O.S. or May Day by radio telephone; I may require assistance; I may be forced to land without further signal. State the time and position; transmit course, height, and ground speed maintained, and transmit the estimated position of ditching (this information secured from navigator). On pilot's order, clamp down key.

2. Release each gun from its mount and lift it high enough to slacken tension on the bungee cables; and as the tail gunner pulls the cable forward, unsnap each cable.

3. Unload guns, disconnect feed chutes and sacks, and throw each gun through its respective window.

4. Chop the remaining glass from the side windows with the hand axe.

5. Throw camera and other predetermined unnecessary equipment overboard.

6. Each man proceed to ditching station.

e. SEA AND WIND CONDITIONS AFFECTING DITCHING.

(1) GENERAL.

(*a*) With a calm sea, there may be a little or no wind, making it essential to ditch with the lowest IAS possible. Such a sea is deceptive with regard to judgment of altitude, particularly if the surface is "glassy." If there are ripples upon the surface, judgment of altitude is improved.

(b) Waves always move with the wind except when close in shore and in fast flowing estuaries. Waves are the direct result of the wind which creates and maintains them.

(c) "Swell" is an undulating movement of the surface caused by past or distant disturbances by action of the wind. A swell does not necessarily move with the wind, and it has no breaking crests. If the wind is blowing across the swell, a cross-sea is created with the waves (which are moving down-wind) running on the swell.

(2) WIND DIRECTION.—In the absence of any fixed mark (land, lightship, etc.) or floating object not under way, the pilot can only judge his motion relative to the motion of the waves.

(a) Waves move down-wind and the line of the wind can be taken to be at right angles to the lines of the wave crests.

(b) If there is sufficient wind, waves break, and they break down-wind. This can readily be observed from a low altitude. If the aircraft is flown at right angles to the breaking waves, the direction of drift will be apparent.

(c) If there is enough wind to blow the spray off the wave crests, the direction in which the spray moves is reliable.

(d) Where the surface is not broken up, it is possible to watch gusts rippling the surface in great sweeps, which indicate the wind direction.

(e) Wind on the surface of the sea sometimes produces a series of lines known as "wind lanes," which appear as alternate strips of light and shade. This is a reliable indication of surface wind direction.

(3) STRENGTH OF WIND.

(a) The roughness of the sea is an indication of the strength of the wind, if it has been blowing at the same strength in the same direction for some time.

(b) The wind will be stronger than the appearance of the sea suggests if it is freshening, blowing off a nearby shore, running with tide or swell, and during rain.

(c) Breaking waves may be due to shallow water, and in such circumstances must not be used as a means of calculating wind speed and direction.

(d) General indications of wind speed are as follows:

A few white crests	10 to 20 mph
Many white crests	20 to 30 mph
Streaks of foam along the water	30 to 40 mph
Spray from the crests	40 to 50 mph

f. PROCEDURE DURING DITCHING.

(1) GENERAL.

(a) The pilot must maintain intercommunication with the crew until the last moment and warn them of the impending impact. It is absolutely essential that the crew be braced against impact when the airplane is ditched. However, it is not reasonable to expect a crew to remain braced for long periods; and if they are not in communication with the pilot, the temptation to get up and see how things are progressing may end in one of them being caught out of a ditching station with consequent injury.

(b) The crew must not relax or release themselves in their ditching stations until the airplane has come to rest. The first impact of the tail should not be mistaken for the shock against which they are on guard; it will be followed by a much greater shock as the nose strikes the water after a correct tail-down ditching.

Note

Serious casualties have occurred in these cases where crew members have not taken up proper ditching stations, or where they have relaxed before the final impact. These drills are based on the experience of many ditchings, and such advice and instructions should be implicitly followed. If there are apparent defects in the official drill, the attention of higher authority must be drawn to the fact. There is much to learn concerning ditching, and improvements in drill can still be made.

(2) HANDLING THE AIRPLANE (IMPORTANT PROCEDURE).—The following is recommended:

(a) Ditch airplane before fuel is exhausted, in order to maintain power during landing operation.

(b) Lower flaps to medium setting *only*. (A steep nose-down descent is dangerous because of possible erroneous altitude conception.)

(c) Use engines to flatten out approach.

(d) With only one engine available, use only a little power to flatten approach.

CAUTION

Maintain a *margin* of rudder power in hand right down to the stall. *Do not* open up engine during final stages of landing.

(e) If no power is available, use normal glide approach speed to ensure control and some margin of speed after flattening out.

(f) Choose point for ditching:

1. Towards an oncoming swell preferred.
2. Steep swell—along top.
3. Long ocean swell—up-wind; on upslope towards top.
4. Along a swell across wind—on upslope of swell.

(g) If possible, hold off until all excess speed above stall is lost at the normal three-point (slow landing) attitude.

(h) In a short, moderate, or calm sea, if the airplane bounces, the control column should be held hard back. In the average short sea, the tail should touch the crest of a wave; and as soon as it does so, the nose should be kept up as much as possible. This should cause the forward section to touch down approximately under the CG on the next wave crest.

WARNING

From the air, the open sea always appears much calmer than it actually is.

g. DITCHING CHARACTERISTICS.—The airplane should land tail down. There will be a slight impact as the rear of the airplane strikes, and this will then be followed by a very severe impact with violent deceleration, in most cases. If the airplane has been brought down too fast, a bounce will occur. The nose will bury as the airplane comes to rest; however, if the landing has been carried out correctly, the effect of the nose burying will be minimized and the structure may not collapse.

b. ABANDONING AIRPLANE.

(1) GENERAL.—There are two critical periods in ditching:

(a) The actual handling of the airplane on the water; this is the sole responsibility of the pilot.

(b) The immediate abandonment of the airplane in an orderly manner after ditching; this requires the perfect coordination of the entire crew. Even in a training fuselage in a hangar, this cannot be done efficiently without a great deal of advance practice. Far less can be expected after a severe shock in a fuselage rapidly filling with water unless the drill has been painstakingly planned and practiced. Every crew member must know his job in the

drill to the last detail. Many crews have saved themselves by carrying out a well-executed drill. It requires advance practice—a great deal of it.

(2) PROCEDURE.—The drill procedure after the airplane has come to rest is as follows:

(a) The crew must not release themselves until the airplane comes to rest.

(b) This airplane has a dinghy (life raft) release in the pilot's compartment and the waist gunner's compartment. Should both of these mechanisms fail, the dinghy may be released from outside the airplane by pulling up on the dinghy stowage compartment handle, located above the left-hand flap trailing edge in the fuselage.

CAUTION

Operate the manual release of the dinghy as soon as the airplane comes to rest, but *not before*. Pulling the release before or during ditching can result in inadvertent release of the dinghy as the airplane strikes the water, and the possibility of the dinghy drifting out of reach.

(c) As soon as the airplane comes to rest after the final impact, rise from the ditching stations and collect the equipment detailed to you in the drill. Leave in the correct order by the hatch assigned and carry that equipment allocated to you. Remember that the dinghy radio is the most vital piece of equipment required in the dinghy.

(d) On emerging, inflate your life jacket. Do not be surprised to find that waves may be breaking high and that it is possible to be swept off the airplane. Hold on to the outside of the hatch and await a favorable moment to board the dinghy, but be careful not to block the escape hatch or to hinder the tempo of the drill to any great extent.

(e) If the dinghy should inflate inverted, an endeavor should be made to right it from the wing if the airplane is not sinking rapidly; otherwise, one (and one only) of the crew should jump into the sea and right it. There are two methods of doing this, depending on the type of dinghy:

1. If there are handling patches on the bottom of the dinghy, pull on them with both hands, placing your knees on the buoyancy chamber. While still hauling on the handling patches, lean back and prepare to become submerged for a moment. Even the largest dinghy will turn over.

2. If the dinghy has a ladder arrangement on it rather than the handling patches, place your toe on the bottom of the ladder, and grasp the two nearest stabilizing

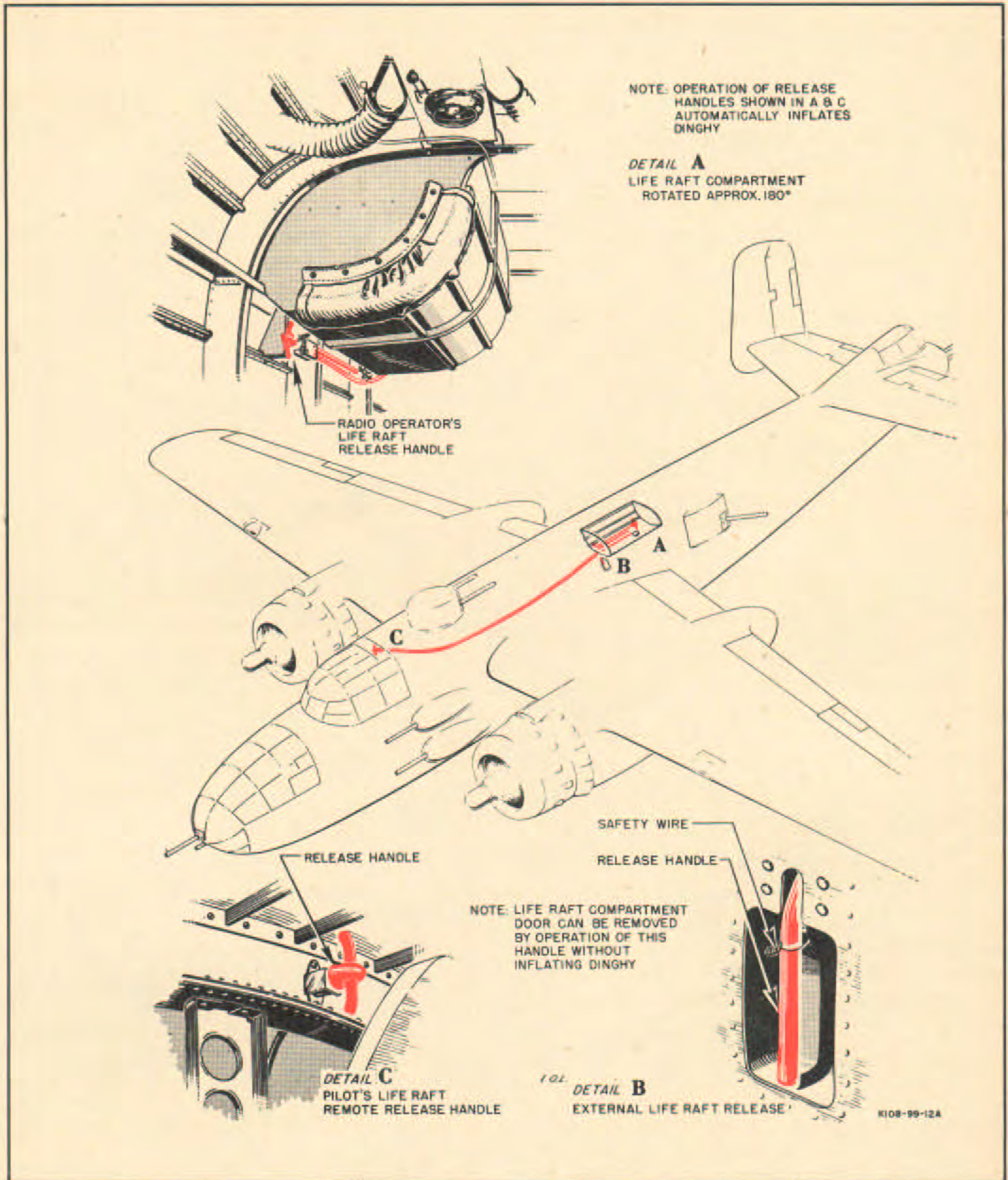

Figure 32—Life Raft Installation

pockets. Lean back and haul on the pockets while pressing on the ladder with your foot.

Note

Do not jump onto the inverted dinghy, as that expels air trapped beneath it and makes righting more difficult.

The painter which attaches the dinghy to the airplane is light so that it will break if the airplane sinks while the dinghy is still attached.

i. BOARDING DINGHY.

(1) If the ditching has been made into the wind, the dinghy should float toward the empennage and the boarding should not be difficult.

(2) If a cross-wind ditching has been made, the airplane will tend to swing into the wind. If the dinghy is on the up-wind side of the airplane, there is a danger of its becoming wedged beneath the wing as the airplane rolls and swings into the wind. If the dinghy is on the down-wind side there is danger of its getting beneath the fuselage or tail assembly, which may be thrashing up and down as the airplane weathercocks into the wind.

Note

Look out for jagged edges which might puncture the dinghy.

(3) Do not jump into the dinghy; doing so could damage it and endanger the lives of the entire crew.

(4) One man in the dinghy can be of great assistance in helping the others aboard.

(5) Avoid getting any wetter than is absolutely necessary. Wet clothes must *not* be taken off; it is far warmer with wet clothes on than off. In hot weather the body should be covered from the sun.

(6) On every dinghy there is a heaving line to be used in aiding crew members to reach the dinghy.

(7) All the above actions concerning the boarding of the dinghy are comparatively simple if the life jacket is fully inflated. If this jacket has been partly inflated by mouth, the mouth valve must be closed before using the CO₂ bottle. A nonswimmer can feel quite confident in a fully inflated jacket, provided the leg straps are secure.

j. ABOARD THE DINGHY.

(1) GENERAL.

(a) Once everyone is aboard, the pilot should call the roll, give the order to cast off, and then the crew should paddle away from the airplane.

(b) The whole crew should then rig the dinghy cover.

(c) Once the dinghy cover is rigged, bail out most of the water.

(d) The crew member so detailed should check for leaks and stop them up with the repair material provided. Another member of the crew is also detailed to connect up the inflating bellows and inflate until the dinghy is rigid. If any of the crew are in the water, inflation of the dinghy will make boarding easier.

(2) USE OF EMERGENCY RADIO TRANSMITTER.—The SCR-578 radio equipment consists of a transmitter, antenna accessories, and a parachute, all contained in two canvas bags stowed in the aft compartment of the airplane. The importance of ensuring that this equipment reaches the dinghy after ditching cannot be too highly stressed. It is the duty of the whole crew to know where this equipment is stowed, so that it will reach the dinghy in any event. Follow the instructions:

(a) PREPARING THE TRANSMITTER.—Remove the transmitter from the bag and place it on the floor of the raft, securing it to the raft if possible. Remove the crank from its stowed position on top of the transmitter case and install it. There is only one crank, so it must be handled with care.

CAUTION

Do not attempt to operate the radio equipment when there is lightning; severe injury to personnel could result.

(b) RAISING ANTENNA.—There are two antennas, one attached to a kite and the other to a balloon. The kite is easier to handle, but if there is not sufficient wind velocity, it will be necessary to use the balloon.

1. THE KITE.—Remove the kite from the accessory bag and assemble it by pushing the "spiders" outward into a "snap" position (similar to an umbrella). Attach the antenna swivel clasp to one of the eyelets of the kite. Then, while standing in the raft (if possible), slowly let out the antenna through the hands, being careful



1. Signal Light Plug
2. Tuning Indicator
3. Tuning Knob
4. Crank Securing Knob
5. Speed Indicator Lamp
6. Generator Crank
7. Selector Switch
8. Keying Switch
9. Antenna Wire
10. Ground Wire

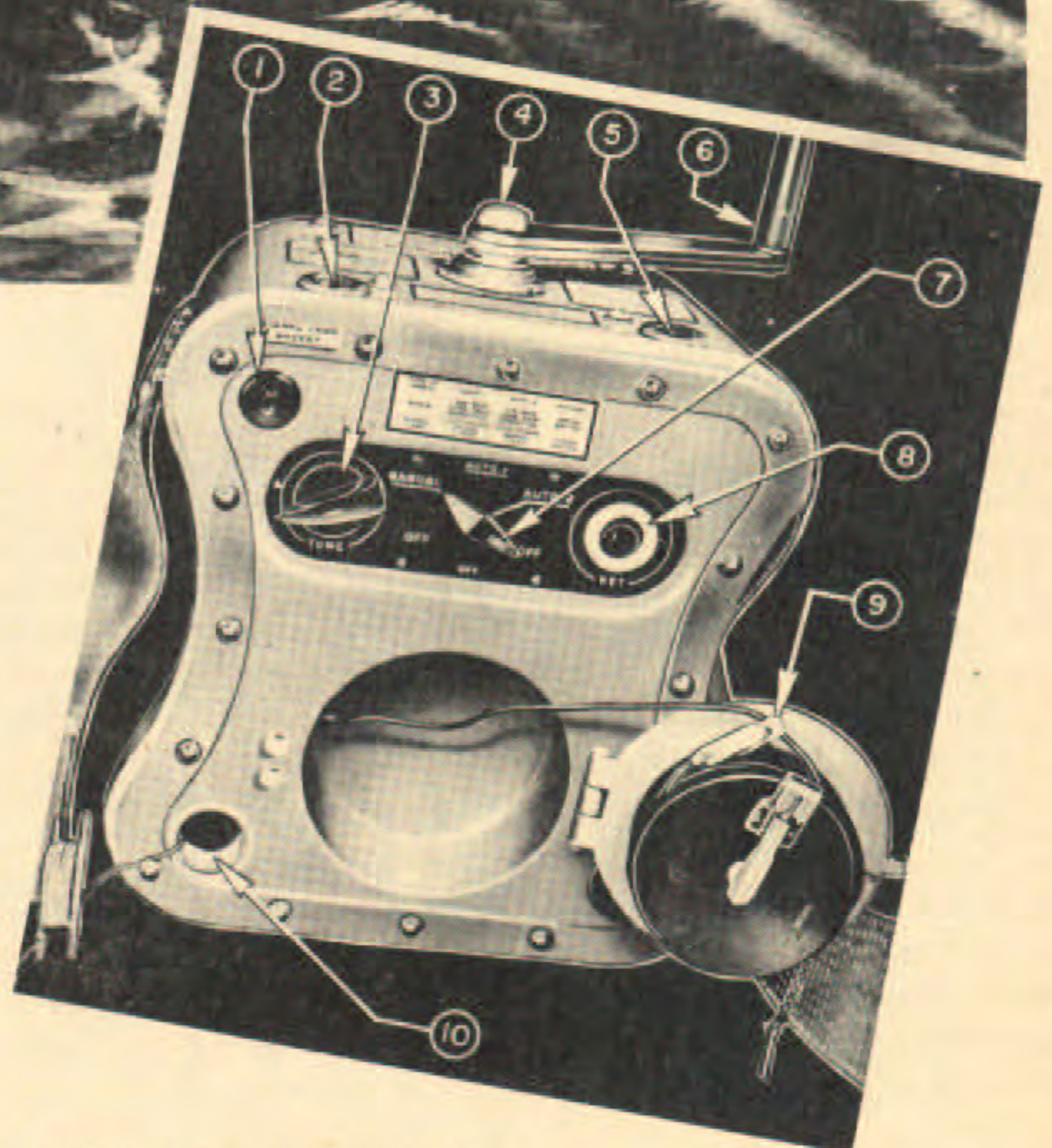

Figure 33—Dinghy Emergency Radio

to prevent the kite from touching the water. The pigtail at the lower end of the antenna is used to attach the antenna to the life raft.

Note

It is important that the antenna be fully extended.

2. INFLATION OF THE BALLOON.—Carefully remove the balloon from the can. The inflating tube is screwed into the top of the generator; remove generator stowage plugs. Wet the needle of the inflating tube and insert it into the balloon valve up to the shoulder. Lower the generator into the water to the depth of the first red line, and hold it there for ten minutes. Then lower the generator to the second red line and hold there until the balloon is completely inflated. Keep the balloon neck from crimping.

Note

If a bubbling sound is heard, raise the generator to the lower red line until it stops. At no time raise the generator out of the water.

More complete information will be found in the booklet stowed in the accessory case attached to the transmitter.

(c) OPERATING TRANSMITTER.—After strapping the transmitter between the legs and releasing the ground wire into the water, set the switch on the face of the transmitter to the desired position. Then turn the crank with sufficient speed to light the indicator lamp, and the transmitter will radiate a signal or the signal lamp will be lit. The transmitter is adjusted to the antenna by turning the tuning control for maximum brilliancy of the "TUNE TO BRIGHTEST" indicator.

(3) OTHER MEANS OF ASSISTING RESCUE.

(a) When craft are in a position to see signals, fire the dinghy pistol or any available pyrotechnics, but conserve as much as possible.

(b) Floating flashlights should be carried by each member of the crew. At night these will allow any member of a crew to show his position if he is separated from the others in the water. These lamps can also be used for signaling. They should be tested periodically without breaking the seal.

(4) RATIONING OF FOOD AND WATER.—This is the duty of the pilot. If he is not there, this duty falls to the copilot.

(a) WATER.—For the preservation of life, water is more valuable than food. It is of the greatest importance that all the available drinking water reach the dinghy. Drink nothing the first 24 hours. Thereafter, drink one pint daily, in small quantities at a time. Do not try to conserve the supply by limiting your daily intake to less than this. Diminish the loss from sweating by keeping cool and exerting yourself as little as possible during the heat of the day. In hot weather keep the body cool by dampening (not soaking) the clothing with sea water.

(b) SOLID FOODS.—The pilot will take stock of available rations in the dinghy and make provision for rationing on a basis of three meals a day for at least six days. The number of days over six for which the pilot makes provision will depend on the distance from shore and the success of the aircraft and dinghy signals.

(c) ENERGY TABLETS.—These tablets are packed in the Emergency Flying Ration. Use these tables strictly in accordance with the instructions printed on the container.

k. UNDERWATER ESCAPE FROM DITCHED AIRCRAFT.

(1) The portable oxygen walk-around assembly (type A-13 demand regulator and type D-2 cylinder, or type A-13 regulator and type A-4 cylinder) together with the demand-type face mask, will permit breathing under water for a limited period of time. Duration depends upon the supply of oxygen in the cylinder and the depth of water at which it is used. A-13 regulator and D-2 cylinder at 400 pounds per square inch will provide oxygen for 5 minutes at a depth of 25 feet. A-13 regulator and A-4 cylinder will provide oxygen for 1 minute under the same conditions.

(2) The demand regulator will function normally providing it is held at the same level as the face mask. If the regulator is lower than the mask, a constant flow of oxygen will be obtained. If the regulator is higher than the mask, increased suction will be required to obtain oxygen during inhalation.

(3) To use portable oxygen assembly during ditching of the aircraft:

(a) Upon assuming ditching position, don portable oxygen assembly as shown in figure 33a. Place one arm and head through loop of sling, making certain regulator is in front of wearer and cylinder rests in armpit. Securely attach two bottom straps of sling to waist.

(b) Place demand type face mask on face and attach securely to flying helmet.

(c) In order to conserve available oxygen in cylinder, connect mask tube to regulator just prior to hitting water.



Figure 33A—Portable Oxygen Assembly

Prearranged signal from pilot or copilot will facilitate timing of this action. In any case make certain to connect mask to regulator before going under water.

(d) Hold on securely to adjacent strong structural member of airplane. This action is prescribed to prevent intrushing water from suddenly dislodging individual from ditching position and throwing him against any protruding objects which may inflict serious physical injury.

(e) Make certain regulator and cylinder assembly is positioned so that sudden impact when hitting water will prevent the assembly from forcibly hitting the wearer in the face or body, and perhaps inflict physical injury.

Note

Since the type A-4 cylinder is not provided with a

carrying sling, the portable assembly consisting of this cylinder and the type A-13 regulator will have to be held manually to prevent losing it.

(f) Remain in ditching position until forward motion of airplane is halted and original violent inrush of water is diminished.

(g) Carefully work way by hand to escape hatch and abandon airplane.

(4) The type D-2 cylinder has sufficient buoyancy to permit an individual to float on the water's surface without inflation of the life vest. However, this fact should not obviate the wear and use of the life vest when in the water away from the airplane.

**6. LANDING GEAR EMERGENCY
LOWERING SYSTEM.**

a. GENERAL.—An emergency hydraulic lowering system is provided for the concurrent operation of the main landing gear and nose gear. The system consists of an emergency hand-pump and a hydraulic fluid reservoir, both in the upper turret gunner's compartment, the necessary automatic valves to regulate normal and emergency flow of fluid to the operating struts, a nose gear up-lock release cable interconnecting the hand-pump handle with the up-lock latch, and fluid transmission lines. The emergency reservoir is connected to the main system reservoir in such a manner that it is automatically filled when the main system reservoir is filled, and is available for emergency lowering of the landing gear *even if the main hydraulic system fluid is completely lost.*

b. OPERATION.—The following is the procedure to be followed when operating the landing gear emergency hydraulic lowering system:

(1) The landing gear control handle in the pilot's compartment must be in the "DOWN" position.

(2) Unlatch bail to release emergency lowering pump handle on the forward wall of upper turret gunner's compartment.

WARNING

The nose gear up-lock is released by a cable interconnected with the emergency hand-pump handle. The first stroke must therefore be a *full* one.

Check pilot's landing gear position indicator to see that the nose gear is partially extended; if it has not been released from the up-lock, give the pump handle another *full* stroke to release the gear from the up-lock.

(3) Operate emergency hand-pump until gear is down and locked.

(4) Retard throttle momentarily to ascertain that gear is locked down, as evidenced by failure of warning light to appear, and, on late airplanes, of warning horn to sound.

(5) Return the emergency pump handle to the up position and latch it. Keep pump handle latched when not in use.

WARNING

Do *not* lower the landing gear by means of the emergency hydraulic system above 150 mph indicated airspeed. The airplane should be in level flight or preferably in a gliding attitude.

Note

The landing gear cannot be retracted by the emergency hydraulic system.

c. EMERGENCY HYDRAULIC OPERATION OF MAIN LANDING GEAR DOWN-POSITION LATCHES.

IMPORTANT

The following emergency operation should be accomplished whenever the main landing gear down-position lockpins fail to engage automatically, regardless of the method used to lower the main landing gear. (Yellow flags on position indicator instrument are visible when lockpins are not engaged.)

(1) With gear fully extended (check position indicator), turn emergency hydraulic selector valve to "LATCH."

(2) Operate pilot's hydraulic hand-pump until position indicator shows main landing gear lockpins in place.

CAUTION

Main landing gear must be fully down prior to using pilot's hydraulic hand-pump, and airplane speed must not be greater than 150 mph. Pressure sufficient to damage lockpin linkage can be obtained with the hand-pump if operated when gear is not fully down.

(3) If the lockpins should inadvertently be pumped to the latched position before the gear is fully extended, the following procedure may be attempted:

(a) Turn the emergency selector valve to "NORMAL" to relieve hand-pump pressure on the lockpins.

(b) Again operate the hand-pump as instructed in 6. b. above, to force the gear past the lockpins.

(c) With the gear fully extended (check position indicators), return the emergency hydraulic selector valve to "LATCH" and operate the hand-pump until the position indicator registers that the lockpins are in place. However, as the above procedure may not work in every case, do not rely on it but consider it rather as a corrective procedure to be attempted only in an extreme emergency.

7. WING FLAP EMERGENCY LOWERING EQUIPMENT.

a. To operate the wing flap emergency control, proceed as follows:

(1) Move the hydraulic flap control in the pilot's compartment to the "NEUTRAL" position.

(2) Remove the handcrank from its stowage position on the forward bulkhead of the waist gunner's compartment, and engage it with the shaft which is located under a flap on the ledge of the bulkhead above the crank stowage position. (Ratchet will be necessary.)

(3) Rotate the crank clockwise until the flaps are in the desired position.

(4) To lock the flaps, remove the crank.

(5) When it is desired to return the flaps to normal operation, engage the crank and turn it counterclockwise as far as it will go; then remove the crank and restore it to its stowed position.

8. EMERGENCY BRAKE OPERATION.

a. EMERGENCY HYDRAULIC BRAKE OPERATION.—Before landing airplane, if there is less than 1000 lbs./sq.in. pressure indicated on the brake system pressure gage, build pressure in the brake system accumulator as follows:

(1) Turn emergency hydraulic selector valve to "BRAKE."

(2) Operate hydraulic hand-pump until brake system pressure gage indicates at least 1000 lbs./sq.in. and not more than 1450 lbs./sq.in.

IMPORTANT

While applying brakes after landing, operate hand-pump continuously to maintain as much pressure as possible in the brake system accumulator as the initial accumulator pressure alone is not adequate for the amount of brake application required for a normal landing.

(3) If a pressure of at least 600 lbs./sq.in. cannot be built up in the brake system accumulator prior to landing, a field with at least *one mile* runway should be found in order to land the airplane safely.

b. EMERGENCY AIR BRAKE CONTROL (EARLY AIRPLANES).

IMPORTANT

The air pressure brake system will be used only as a last resort to stop the airplane if the emergency hydraulic hand-pump operation outlined above cannot be accomplished, or if the pressure obtained with the hand-pump is inadequate for stopping the airplane on the landing field available. *When it is known in advance that the emergency air pressure brake system may have to be used during landing, choose the longest runway available and make the shortest landing possible.* The airplane should be allowed to lose as much speed as possible, consistent with safety, prior to applying the air brakes. As brakes cannot be applied selectively, the pilot must be ready to counteract any uneven action with the throttle.

(1) To apply the emergency air brake, pull up sharply on the control handle (in order to break safety wire) and lower handle halfway almost immediately. Repeat this operation, applying brakes by very quick, successive upward pulls of the handle from the intermediate position until the desired amount of brake action is obtained. Spring action aids in lowering the handle to the halfway (intermediate) position; in this position the air pressure to the brakes will be maintained.

(2) To release the emergency air brakes, it is only necessary to push handle fully down to its normal position.

(3) The air brake may be reapplied with reduced force after having released the pressure in the above manner, by again pulling up on the control handle. The amount of brake action obtained during a second application is dependent upon the length of time the handle was held up during the first application. For example, full pressure is exerted upon the brake discs when the handle is held up for two to three seconds. By applying the brakes

in this manner, only one-third of maximum pressure can be obtained during second application. However, the pilot should depend on only one application.

WARNING

To place the handle in the intermediate position, the handle must be lowered by hand. If handle is released suddenly, a spring will return the handle to its normal position and release the pressure from the brakes. After a landing during which the air brakes were used, taxiing should be done very carefully, as little, if any, brake pressure will be available. Before air brakes are released, it may be necessary for ground crews to block the wheels.

CAUTION

After using emergency air brake system, hydraulic brake system must be bled.

c. EMERGENCY HYDRAULIC BRAKE SYSTEM (LATE AIRPLANES).

(1) GENERAL.—An emergency hydraulic brake system (see figure 33A) is provided for the operation of the brakes in the event of normal brake system failure. Pressure for the system is supplied from the general hydraulic system, and a check valve maintains the pressure in the emergency brake system *even if the general hydraulic system fluid is completely lost.* The brakes may be applied either selectively or simultaneously by means of control handles on the lower pedestal. A ratchet holds the handles in position after the desired amount of braking action is obtained. The brake action obtained through use of the emergency system is similar to that obtained when using the brake pedals.

(2) OPERATION.

(a) Pull up on control handles until desired braking action is obtained. The amount of braking action increases as the handles are pulled up.

(b) To release brakes, push down on the handles.

Note

Adequate pressure is available for four applications. The effectiveness of further applications depends on the pressure remaining in the emergency system accumulator.

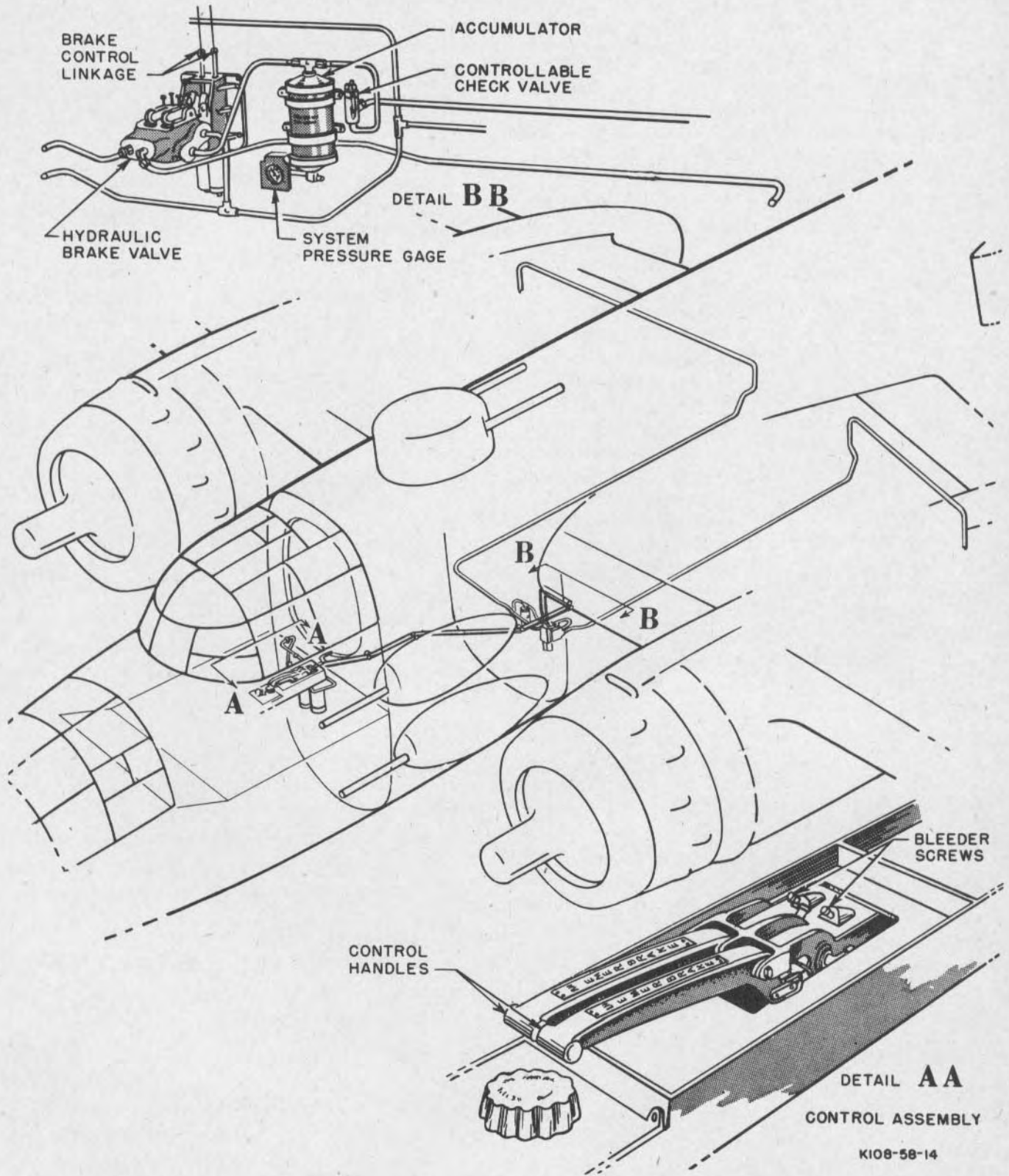
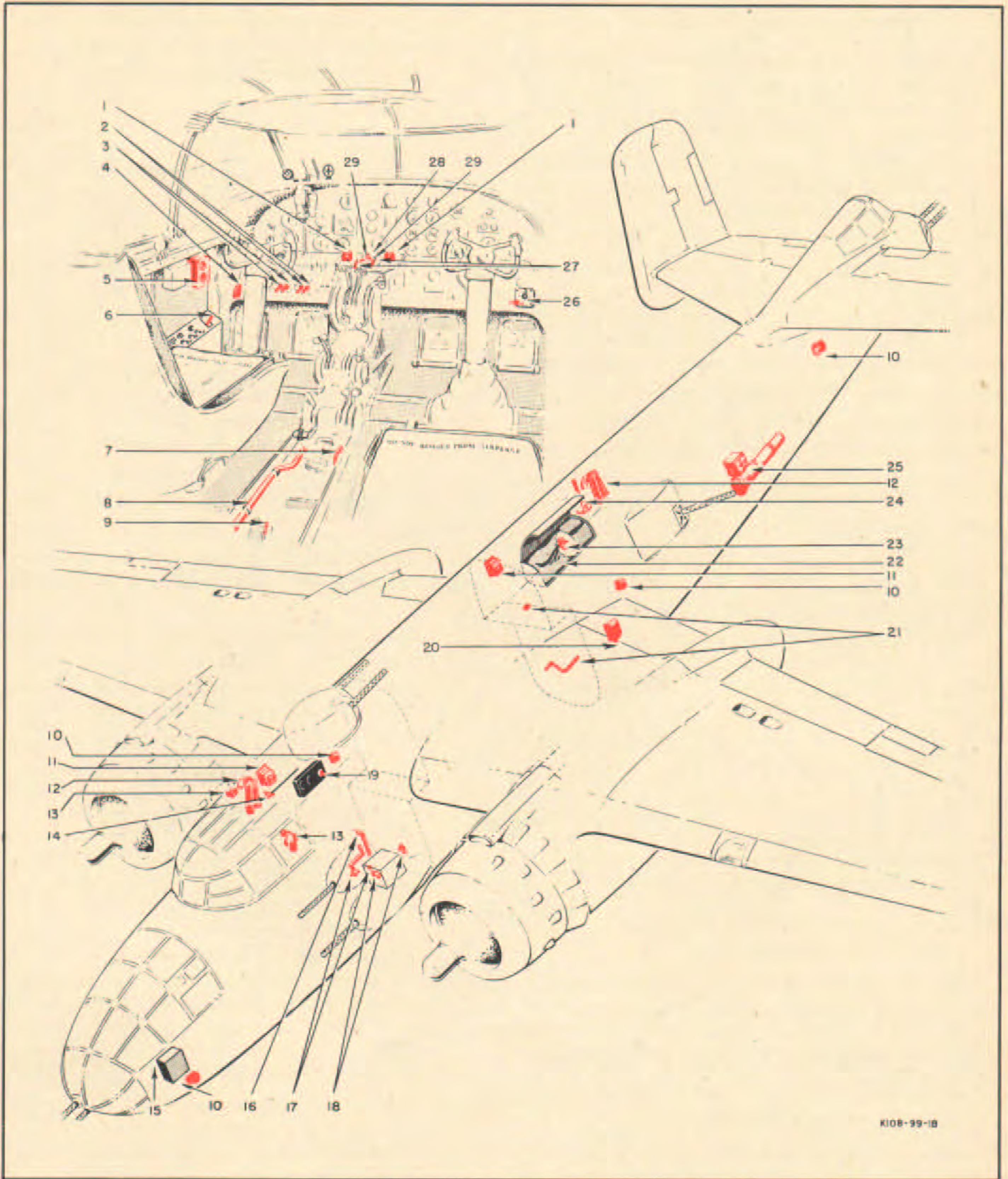

Figure 33A—Emergency Hydraulic Brake System (Late Airplanes)

KEY TO FIGURE 34

1. Propeller Feathering Switches
2. Oil Dilution Switches
3. Battery-disconnect Switches
4. Crew Warning Switch
5. Radio Demolition Switches
6. Pilot's Bomb Salvo Switch
7. Emergency Air Brake Control
8. Emergency Hydraulic Hand-pump
9. Emergency Hydraulic Selector Valve
10. Crew Warning Horns
11. First-aid Kits
12. Portable CO₂ Fire Extinguishers
13. Pyrotechnic Pistol and Socket Fitting
14. Pilot's Life Raft Release
15. Bombardier's Bomb Salvo Switch
16. Hand-operated Emergency Fuel Pump
17. Bomb Door Crank and Fitting
18. Emergency Bomb Door Control Valve & Operating Handle
19. Inverter Switch
20. Impact Switch
21. Wing Flap Handcrank and Fitting
22. Life Raft
23. Waist Gunner's Life Raft Release
24. Fire Axe
25. Dinghy Radio
26. Engine Fire Extinguisher Control
27. Fuel Transfer Pump Switches
28. Ignition Master Switch
29. Magneto Switches



K108-99-1B

Figure 34—Emergency Equipment

9. GUN TURRET EMERGENCY OPERATION.

a. UPPER TURRET.—In case of turret power failure, it is possible to stow the guns manually by means of the handcrank and extension shaft stowed at the base of the turret. This is accomplished as follows:

(1) Lower the guns by attaching the extension shaft to the elevation speed reducer located forward of the gun sight, attaching the handcrank to the extension shaft, and turning the handcrank clockwise (looking down).

(2) Rotate the turret so the guns point straight aft by engaging the handcrank with the end of the azimuth shifter shaft located at base of the turret, pulling the shaft out approximately $\frac{1}{2}$ inch with the crank, and turning the crank. The turret rotates clockwise when the crank is turned counterclockwise (looking from the shaft end).

b. TAIL TURRET.—If the hydraulic or electrical systems of the turret fail, operate the guns manually as follows:

(1) Open the elevation and azimuth by-pass valves, located between the armor plate and upper section of the control tower.

(2) Swing open the armor plate panels to gain access to the manual grips mounted above and between the guns.

(3) Move the guns manually by the grips. The manual grips are moved into position by pulling release pin, lifting handles, and turning clockwise as viewed from top. Fire the guns by pressing the trigger switches on the grips, or by pulling the mechanical triggers on the grips if the electrical circuit is defective.

Note

If the electrical circuit fails, it will be necessary to break the ammunition belts into 75-round units, since the booster motors will be inoperative.

10. BOMB OR DROPPABLE FUEL TANK EMERGENCY RELEASE.

When the hydraulic system is functioning normally, bombs or the droppable fuel tank may be released by actuating either bomb salvo switch. This causes the bomb doors to open automatically and the bombs or the droppable fuel tank to be released.

WARNING

Prior to releasing bombs in an emergency, position the bomb nose fusing switch as desired; always move the switch to "OFF" if over friendly territory. If over enemy territory, turn bomb mas-

ter switch and nose fusing switch "ON." To close the bomb doors, move the bomb master switch to "ON" and the bomb door control switch to "CLOSE."

Note

In case of hydraulic system failure, crank the bomb bay doors open mechanically as described in the paragraph below.

11. BOMB BAY DOOR EMERGENCY OPERATION.

If the bomb bay doors fail to open when the bomb door control switch is placed in the "OPEN" position, as evidenced by failure of the bomb door indicator light to illuminate, pull out on the bomb door control valve override handle at the base of the upper turret. If the indicator fails to illuminate, or the doors still do not open after pulling the handle, proceed as follows:

a. Remove bomb bay door operating handcrank from its stowage on the lower right longeron opposite the turret pedestal.

b. Place the crank in the drive socket on the forward face of the upper turret pedestal with the handle positioned upwards.

c. Turn crank clockwise to open the doors, and counterclockwise to close the doors. An automatic clutch mechanism incorporated in the crank makes it possible to operate the crank in either direction and serves to help hold the doors in position.

IMPORTANT

After closing the bomb bay doors with the crank, thread the strap on the crank handle through the tie-down loop on floor below crank, and tighten securely. This is necessary, as the brake action of the crank clutch mechanism is not sufficient to hold doors closed. Normally, the doors are held in the open and closed positions by hydraulic pressure. It is not necessary to secure operating crank with the strap to hold bomb bay doors in the open position.

WARNING

If it is necessary to make an emergency exit through the front entrance hatch when the bomb bay door handcrank is installed, first untie the strap and open the bomb doors; then remove the handcrank. The doors will remain in the open position when the crank is removed. The

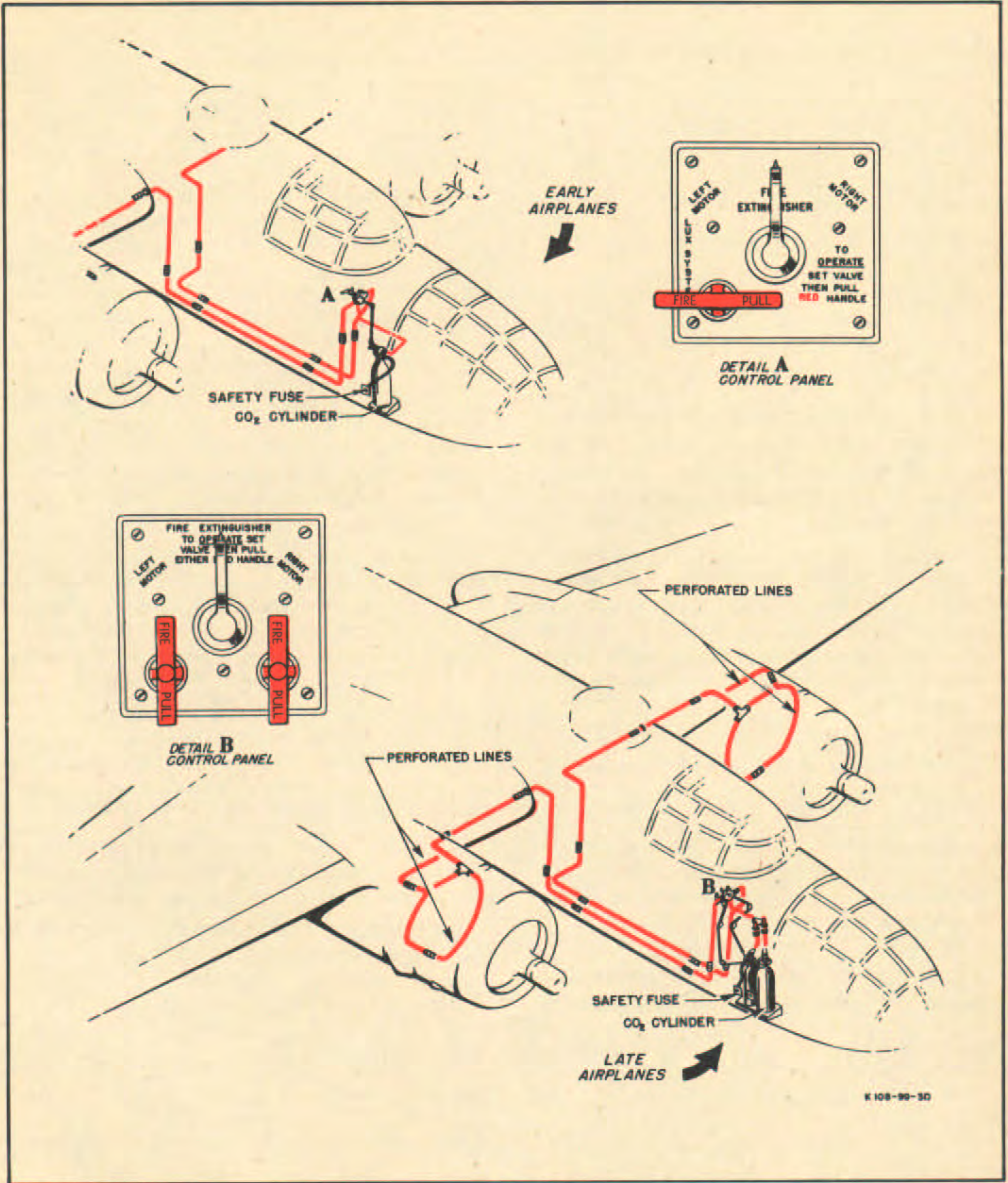

Figure 35—Engine Fire Extinguisher Systems

handcrank must be removed to make it possible to raise the inner door of the hatch. As the bomb bay doors fall approximately two thirds open when there is hydraulic system pressure failure, regardless of the position of the bomb door control switch, an emergency exit through the front entrance hatch might result in serious personal injury if the bomb doors were only partially opened.

12. TORPEDO EMERGENCY RELEASE.

To release the torpedo in an emergency, move either bomb salvo switch to the "ON" position. Then close the bomb doors by turning bomb master switch "ON" and door switch to "CLOSE." In case of hydraulic system pressure failure, refer to paragraph 11 above.

13. MISCELLANEOUS EMERGENCY EQUIPMENT.

a. ALARM HORNS.—The alarm horns located at all crew stations are controlled by a switch in the lower left section of the pilot's switch panel. The switch lever is red and bears the word "ALARM."

b. LIFE RAFT.—A life raft, stowed in the upper forward left corner of the waist gunner's compartment, is provided for use after a forced water landing. Necessary emergency equipment, including rations, oars, hand-pump, signal flare pistol, rubber patches, etc., is stowed in the life raft. A CO₂ cylinder for the inflation of the raft is also a part of the unit.

c. LIFE PRESERVER.—The back cushions on the pilot's and copilot's seats are filled with kapok and may be used as life preservers.

d. EMERGENCY FUEL PUMP.—An emergency fuel transfer hand-pump is located on the floor of the upper turret compartment. In the event of failure of the electric pumping system, fuel may be transferred from the fuselage tanks to the wing tanks by the operation of this hand-pump.

e. EMERGENCY FUEL SHUT-OFF VALVE.—Two emergency fuel shut-off valves on the shelf at the aft end

of the upper turret compartment are for use should the pilot be unable to operate the shut-off valve in the cockpit.

f. RADIO DEMOLITION SWITCH.—A switch controlling the charge for demolishing the identification radio in an emergency is located on the left side of the pilot's compartment. Both buttons must be depressed simultaneously to set off the charge.

g. FIRST-AID KITS.—Two first-aid kits are furnished; one is stowed in the upper forward right corner of the upper turret compartment and the other in the upper forward right corner of the aft compartment. These kits include a supply of compresses, dressings, iodine swabs, boric acid ointment, morphine tartrate, and sulfanilamide crystals and tablets, halazone tablets, as well as a pair of scissors, a tongue depressor, and a tourniquet.

h. PORTABLE FIRE EXTINGUISHERS.—Two CO₂ fire extinguishers are furnished. One is installed on the right side of the upper turret gunner's compartment, and the other is mounted on the right side of the aft compartment aft of the waist gun window.

i. ENGINE FIRE EXTINGUISHER.—A fire extinguisher system for extinguishing engine fires is provided. On early airplanes, one CO₂ bottle in the nose wheel well supplies CO₂ to either engine upon operation of the selector valve and pull-handle assembly mounted on the right instrument subpanel. On late airplanes, two CO₂ bottles are provided.

j. FIRE DETECTOR.—On late airplanes, a fusible tin-alloy fire detector is installed on the firewall of each nacelle. The detectors are connected electrically to warning lights on the right side of the pilot's instrument panel. Contact is made at 204°C (400°F).

k. HAND AXE.—A hand axe for emergency use is mounted on the right side of the fuselage in the waist gunner's compartment.

l. BOMB DOOR CONTROL VALVE HANDLE.—A handle for emergency operation of the bomb door control valve, in the event of partial electrical system failure, is located in the housing at the base of the upper turret.



SECTION V OPERATIONAL EQUIPMENT

1. PILOT.

Note

The following instructions apply only to operational equipment not normally used by the pilot during flight. For flight operating instructions, see Section II.

a. BOMBING EQUIPMENT.

(1) DESCRIPTION.—The bomb control panel is located on the left side of the pilot's compartment. See figures 36 and 37 for the differences between bomb control panels used on early and late airplanes. A Type B-3 bomb interval control may be attached to a mount on the right side of the pilot's compartment to permit the pilot to release bombs selectively or in a train. The bomb release switch is on the pilot's aileron control wheel. A bomb sight assembly on top of the gun sight may be used for minimum altitude (horizontal) bombing.

(2) OPERATION.—Since the bombing equipment operated by the pilot is similar to that operated by the bombardier, see paragraph 2. a. (2) following for operation.

b. TORPEDO EQUIPMENT.

(1) DESCRIPTION.—A torpedo may be carried as an alternate bomb load. The torpedo equipment is not supplied with the airplane and must be obtained as a kit. With the torpedo installed, the bomb bay doors are only partially closed and rest against the pads on the torpedo rack. The doors must be fully opened before dropping the torpedo. After the torpedo is released, the protruding parts of the torpedo rack automatically retract and the bomb doors may then be closed. No bombs can be carried in the bomb bay when the torpedo rack is installed.

(2) OPERATION.—The torpedo is released as follows (see figure 39):

(a) Set bomb interval control train-selective switch in "SEL."

(b) Turn bomb master switch "ON" and move bomb door switch to "OPEN."

(c) Prior to launching the torpedo, maneuver the airplane and make corresponding adjustments on the torpedo director as follows:

1. Approach target from desired direction. With the latch knob (see figure 38-2) aft and the director locked

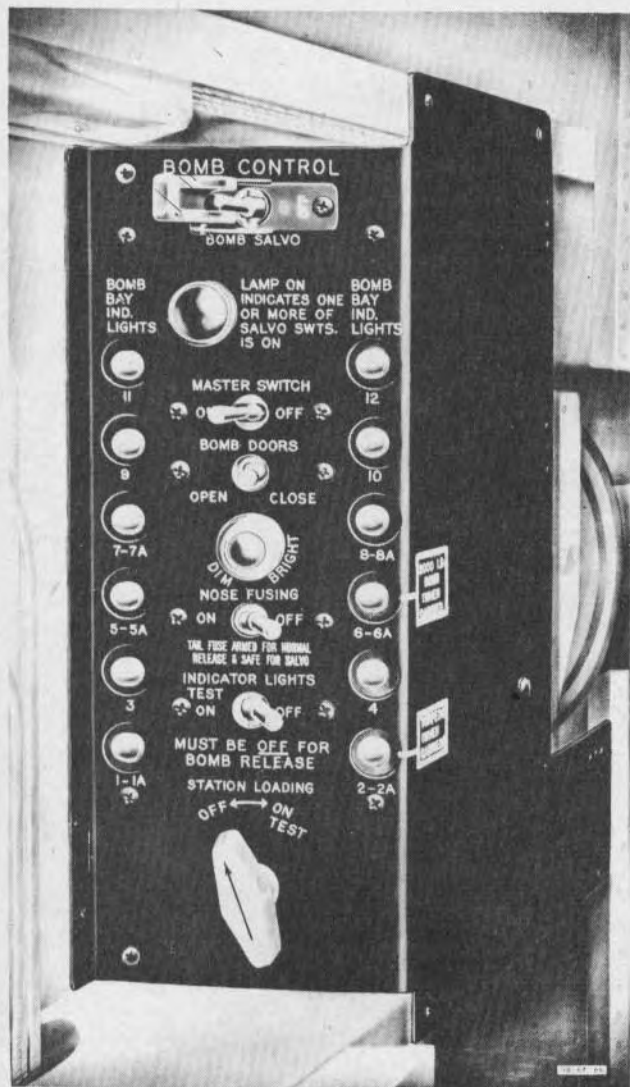

Figure 36—Pilot's Bomb Control Panel—Early Airplanes

in the forward position, align the airplane so that the luminous vertical crosshair appears on target.

2. With lock knob (*see figure 38-3*) loosened and the target arm unlatched by turning knob (*see figure 38-2*) down, break the linkage out into a triangle so that the small engraved arrow on the target arm is pointing in the direction of the target course.

3. Estimate the target speed in knots and adjust the target speed adjustment knob (*see figure 38-12*).

4. Estimate direction of target course and rotate target arm to appear reasonably parallel to target course.

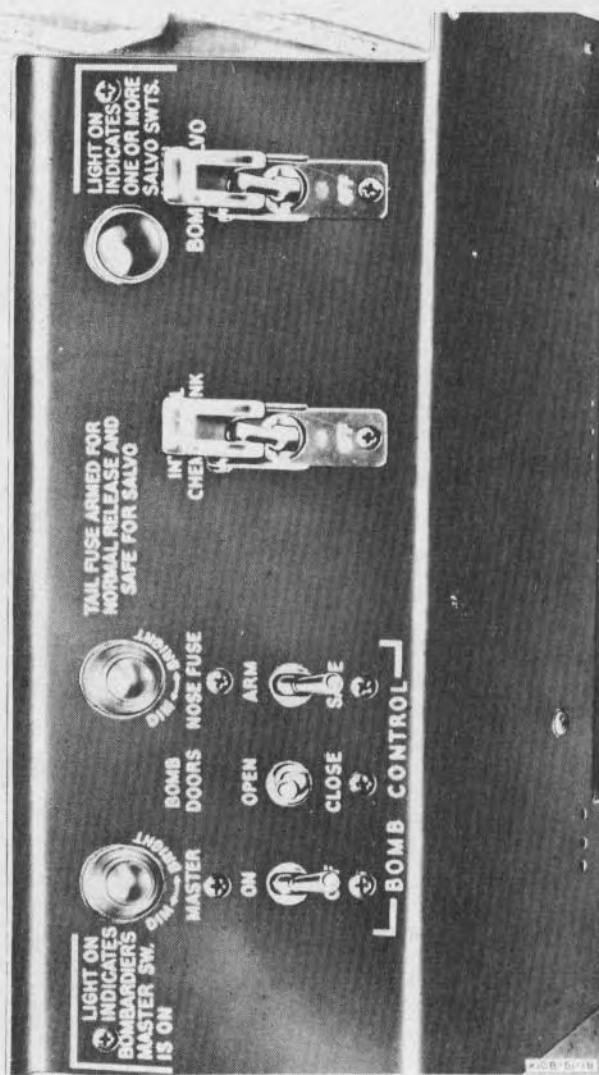

Figure 37—Pilot's Bomb Control Panel—Late Airplanes

Lock the triangle by tightening the lock knob (*see figure 38-3*).

5. Turn latch knob (*see figure 38-2*) up and swing the director sight into the position where torpedo arm (*figure 38-4*) latches forward.

(d) Maneuver the airplane left or right so that target is brought anew into coincidence with the luminous vertical crosshair.

(e) As soon as the airplane is steadied on the new interception course, press bomb release switch.

(f) Turn bomb door control switch to "CLOSE" and turn "OFF" bomb system master switch.

c. GUNNERY EQUIPMENT.

(1) DESCRIPTION.—A Type N-3B or N-3C optical gun sight is located on the left side of the glare shield. On early airplanes the gun sight is equipped with a Type A-1 combination gun sight head; on later airplanes it is equipped with a Type L-1X-N head (see figures 40 and 41). An auxiliary ring-and-bead sight is also provided; the ring sight is on the shield to the right of the gun sight and the bead sight is forward of the pilot's windshield. The pilot sights and fires the following guns:

(a) One fixed, forward-firing M-2 .50-caliber gun mounted in the nose section. Late airplanes are equipped with two .50-caliber fixed nose guns, and provisions are made to convert the flexible nose gun to a fixed gun.

(b) Four fixed .50-caliber guns, mounted in blisters, two on each side of the fuselage. Each gun is provided with a 400-round ammunition box.

(2) OPERATION.

Note

The fixed nose guns are charged manually by handles in the pilot's compartment. The blister guns are charged manually by handles located at the forward end of the upper turret compartment.

(a) To sight blister guns and nose gun, see that the gun sight reflector is set for gunnery. If the reflector is set for bombing or the gun sight is inoperable, use the ring-and-bead sight for sighting the guns. Turn gun sight rheostat "ON."

(b) To fire the guns, turn gun safety switch to "FIRE" and press the gun trigger switch on the control wheel.

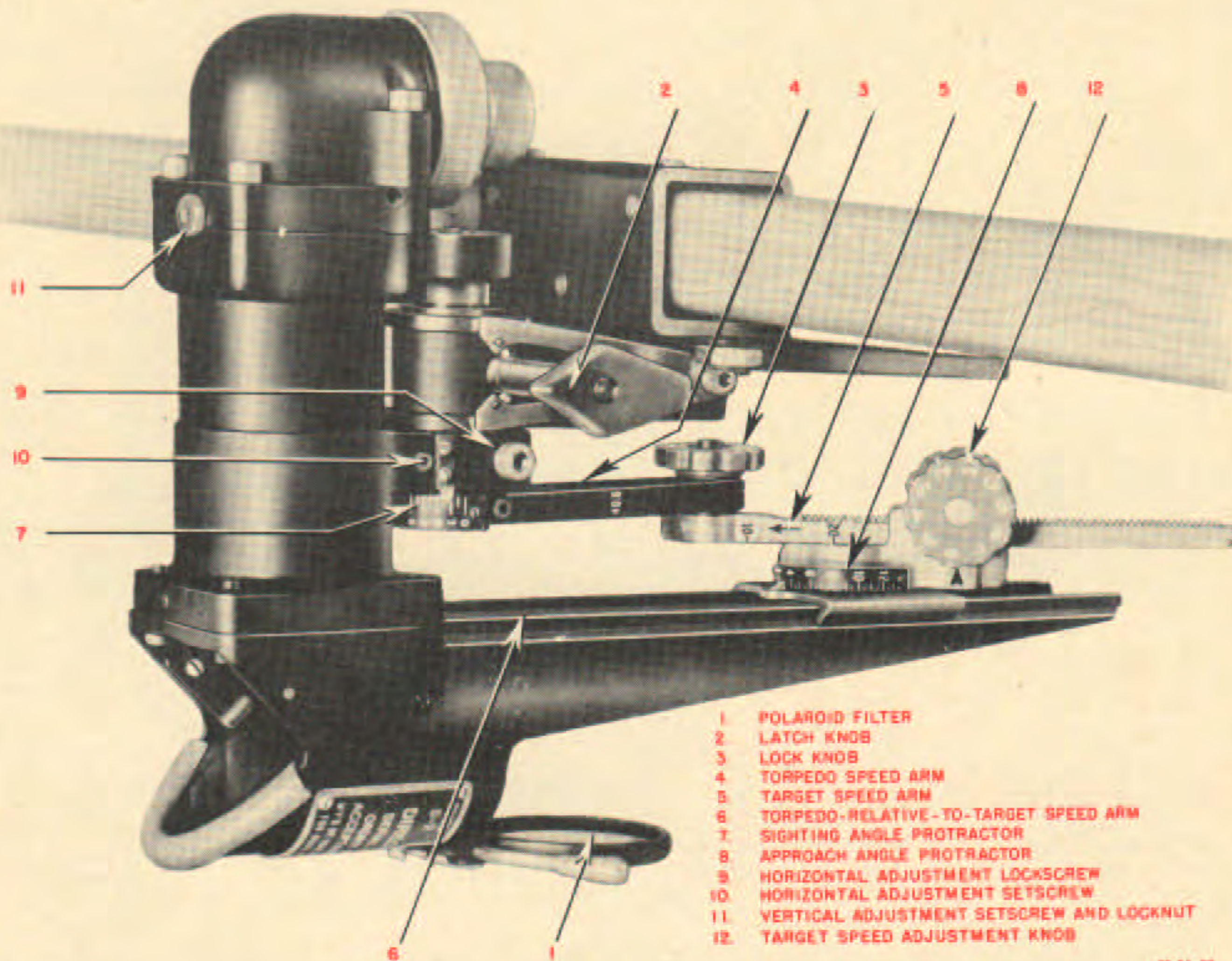

- 1. POLAROID FILTER
- 2. LATCH KNOB
- 3. LOCK KNOB
- 4. TORPEDO SPEED ARM
- 5. TARGET SPEED ARM
- 6. TORPEDO-RELATIVE-TO-TARGET SPEED ARM
- 7. SIGHTING ANGLE PROTRACTOR
- 8. APPROACH ANGLE PROTRACTOR
- 9. HORIZONTAL ADJUSTMENT LOCKSCREW
- 10. HORIZONTAL ADJUSTMENT SETSCREW
- 11. VERTICAL ADJUSTMENT SETSCREW AND LOCKNUT
- 12. TARGET SPEED ADJUSTMENT KNOB

Figure 38—Torpedo Director

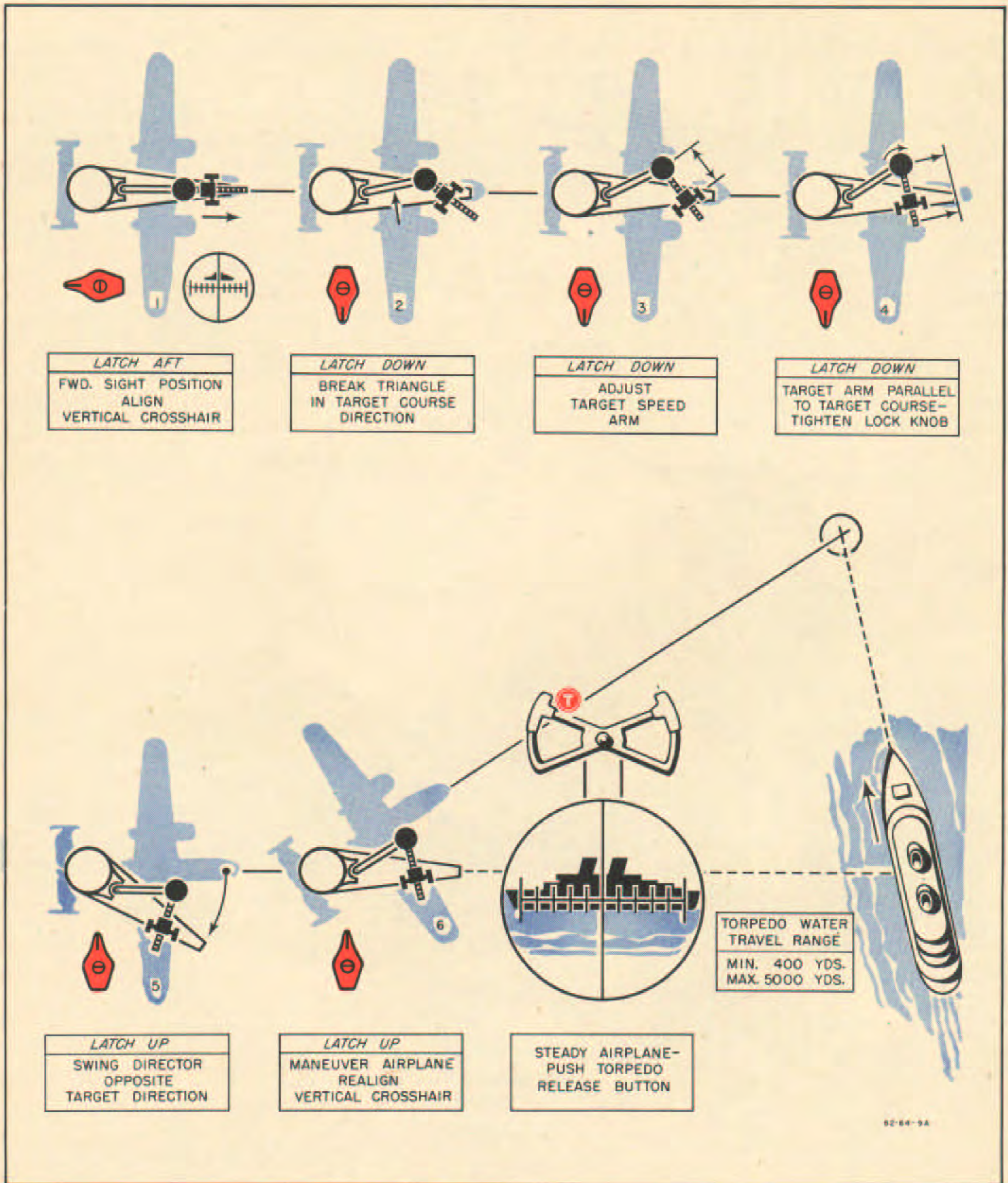

Figure 39—Operation of Torpedo Director

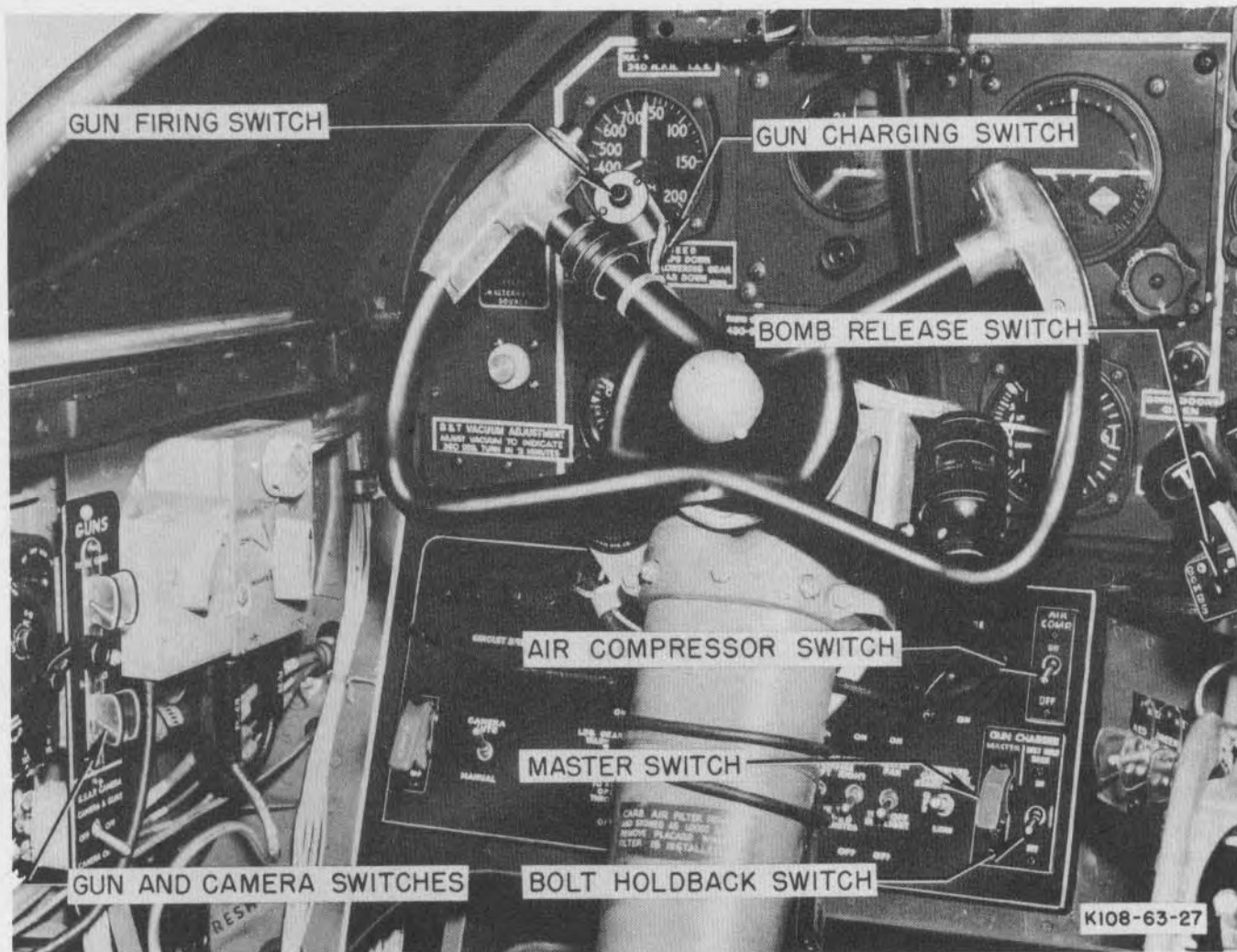

Figure 39A—Eight Gun Nose Controls (Typical)

WARNING

Before landing, make sure that gun master switch is "OFF."

(3) EIGHT GUN NOSE.

(a) DESCRIPTION.—Nose and blister guns are charged simultaneously by the gun charging switch. Gun bolts are held back by the bolt holdback switch and are released to battery when the holdback switch is turned "OFF" or when the firing switch is pressed to fire guns. The "AIR COMP" switch turns on the compressor to build and maintain pressure in the air tanks. (See figure 39A.)

(b) CHARGING GUNS.

1. Turn "ON" master switch on pilot's switch panel before take-off, and leave it "ON" during flight.

2. Turn "ON" pump switch on pilot's switch panel before take-off, and leave it "ON" during flight.

3. Make sure bolt holdback switch is "ON."

4. Hold the charging button "ON" for one second. When the bolt holdback switch is "OFF" bolts return immediately to the battery position. Charging the guns with the bolt holdback switch "ON" prevents the bolts returning to the battery position.

WARNING

The gun firing procedure is identical whether the bolts are held back or in battery position. However, the bolt holdback switch must be in the "ON" position while on the ground, during landing or take-off, and during violent maneuvers in order to prevent accidental discharge of the guns.

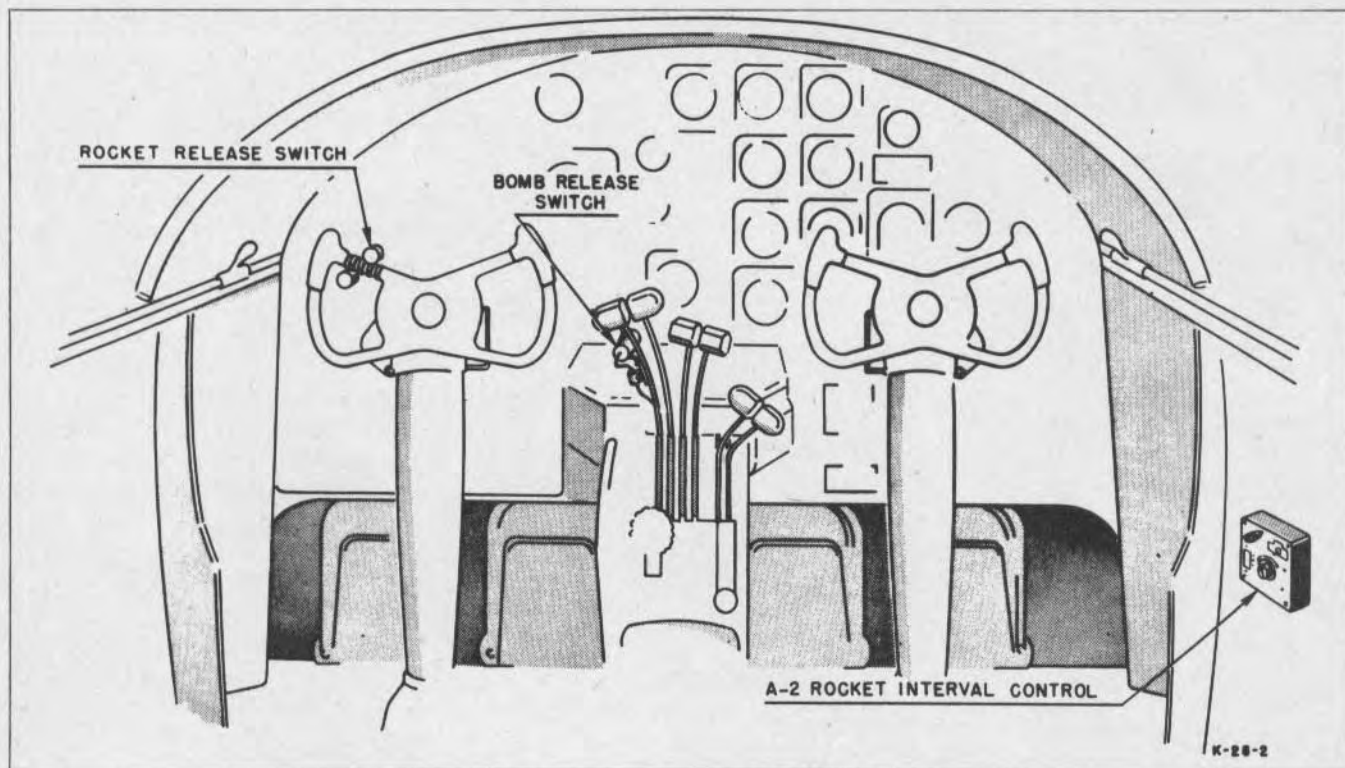

Figure 39B—Rocket Release Controls

5. During normal flight, the bolts should be placed in battery position, either by turning "OFF" the bolt holdback switch momentarily or by firing guns.

6. To charge only the blister guns, push the button on the solenoid at the opening of the crawl tunnel.

(c) FIRING GUNS.

1. Turn camera switch to "GUNS AND CAMERA."
2. Turn "ON" selector switch for desired guns.
3. Press firing button.

(d) COOLING GUNS.

1. Turn "ON" bolt holdback switch.
2. Charge guns once.

d. ROCKET EQUIPMENT.

(1) DESCRIPTION.—On late airplanes, four sets of launchers, each designed to carry a 5" high velocity aircraft rocket, are mounted on the under surface of each wing. Rockets are released by a button on the pilot's control wheel. (See figure 39B.) An A-2 projector release control, on the right side of the pilot's compartment, provides automatic release of all or part of the rockets at 1/10-second intervals. Rockets may be set to explode on impact, or .015-second after impact, by setting the fuse-arm-

ing selector switch on the release control. The release circuit is designed to alternate the firing sequence from one wing to the other. Thus, the rockets are designated by odd numbers on the left and even numbers on the right.

(2) FLIGHT PROCEDURE.—In firing rockets against ground targets by a depressed sight line, the sight correction is determined by anticipated attacking conditions, and adjusted to the zero sight line by the pilot.

(a) LOW LEVEL APPROACH.—Approaching at high speed, at levels up to 100 feet above target, the pilot should gradually pull up until the rocket sight line intersects the target 75-100 yards before reaching the correct firing point. The airplane then is flown over a smooth curve (slightly nose up, then gently nose down), at a rate which will hold the target in the sight over the top section of this arc. Thus, the pilot is continuously on the target through a brief period. He should fire rockets at top of the arc, and follow through the curve briefly, and into a climbing turn to avoid flying debris from the explosion. Following the curve briefly after firing is essential, to prevent possible firing during the pull-up.

(b) DIVE ATTACK.—A 30° flight-line approach at a minimum 1000-yard range is best for these attacks. A curve similar to that of the low level approach is flown at the correct range. The airplane will traverse the top of

the arc at proper range, if the sight is correctly set for existing attack conditions. Shooting accuracy will not be seriously affected by the brief period in which the pilot is attempting to keep on target, for the airplane itself is following the correct flight path despite momentary deviations of the sight line. Inaccuracy is produced largely by a false estimation of range.

(3) FIRING ONE ROCKET.—To fire rockets singly:

(a) Select with "RESET" knob the rocket to be released.

(b) Turn selector switch to "INST" or "DELAY," as desired.

(c) Set firing switch to "SINGLE."

(d) When airplane is on target, as described above, press button marked "ROCKETS," on pilot's control wheel. As each rocket is fired, the release control automatically selects the next for firing.

(4) AUTOMATIC FIRING.

(a) With "RESET" knob select first rocket to be fired.

(b) Turn selector switch to "DELAY" or "INST."

(c) Set firing switch to "AUTO."

(d) To begin firing, press "ROCKETS" button on control wheel. The selected number of rockets will be fired at 1/10-second intervals while button remains depressed.

e. CHEMICAL TANK EQUIPMENT.

(1) DESCRIPTION.—Late airplanes are wired to allow the use of M-10 chemical tanks on modified wing bomb racks and M-33 chemical tanks on the bomb bay racks. Power for igniting the chemical in the tanks is obtained from the bomb system circuit. After the chemical is depleted, the tanks may be released by means of the bomb release system.

(2) OPERATION.—To set the desired chemical tank in operation, turn "ON" its respective switch on the bomb control panel. On early airplanes, the chemical tank in the bomb bay is operated by a switch on the pilot's switch panel.

f. COMMUNICATION EQUIPMENT.

(1) DESCRIPTION.—The pilot operates the following radio equipment:

(a) COMMAND SET.—The command set may be either an SCR-274-N, SCR-522 or both. The SCR-274-N radio set consists of two transmitters and three receivers with independent control boxes for each group, an antenna relay, and accessory items for interconnection of the units. See figure 43 for location of equipment. The SCR-522 radio set is mounted on the bomb bay crawl deck. The control box is on the right side of the pedestal switch box.

(b) IFF EQUIPMENT.—The set consists of the receiver and transmitter unit, control box, detonator switches, an inertia crash switch, and two indicator lamps. See figures 43 and 56 for location of this equipment.

(c) RANGE FILTER EQUIPMENT.—The FL-8 range filter (figure 43) serves to separate the voice-given weather reports from the radio range signals.

(d) SCR-570 RADIO SET (LATE AIRPLANES).—The SCR-570 receiving equipment which indicates vertical and lateral guidance during landing operations consists of two receivers: R-47/ARN5A, used for vertical guidance and the BC-733-D for lateral guidance, an indicator, an antenna, control box, and the necessary wiring.

(e) MARKER BEACON (LATE AIRPLANES).—The marker beacon receiver, installed in the right rear corner of the nose wheel, is connected to an indicator light on the instrument panel. Operation of the indicator light is fully automatic when the radio compass receiver is turned "ON."

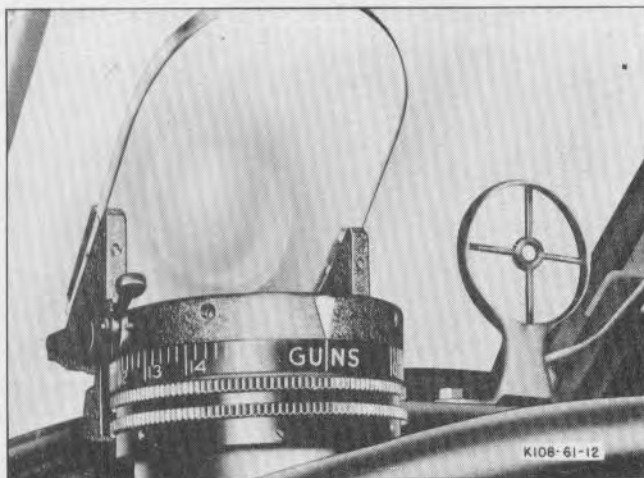

Figure 40—Gun Sight Head—Late Airplanes



Figure 41—Gun Sight Head—Early Airplanes

(2) OPERATION.

(a) SCR-274-N COMMAND SET.—The frequency range of the command set is as follows:

BC-457-A Transmitter	4000 to 5300 kilocycles
BC-459-A Transmitter	7000 to 9100 kilocycles
BC-453-A Receiver	190 to 550 kilocycles
BC-454-A Receiver	3000 to 6000 kilocycles
BC-455-A Receiver	6000 to 9100 kilocycles

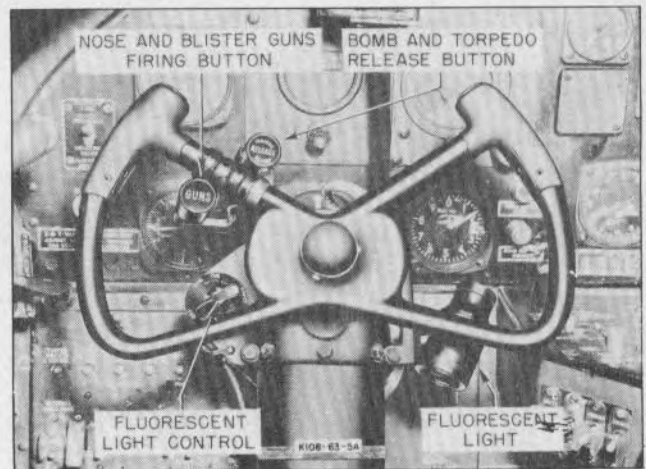

Figure 42—Gun and Bomb Switches

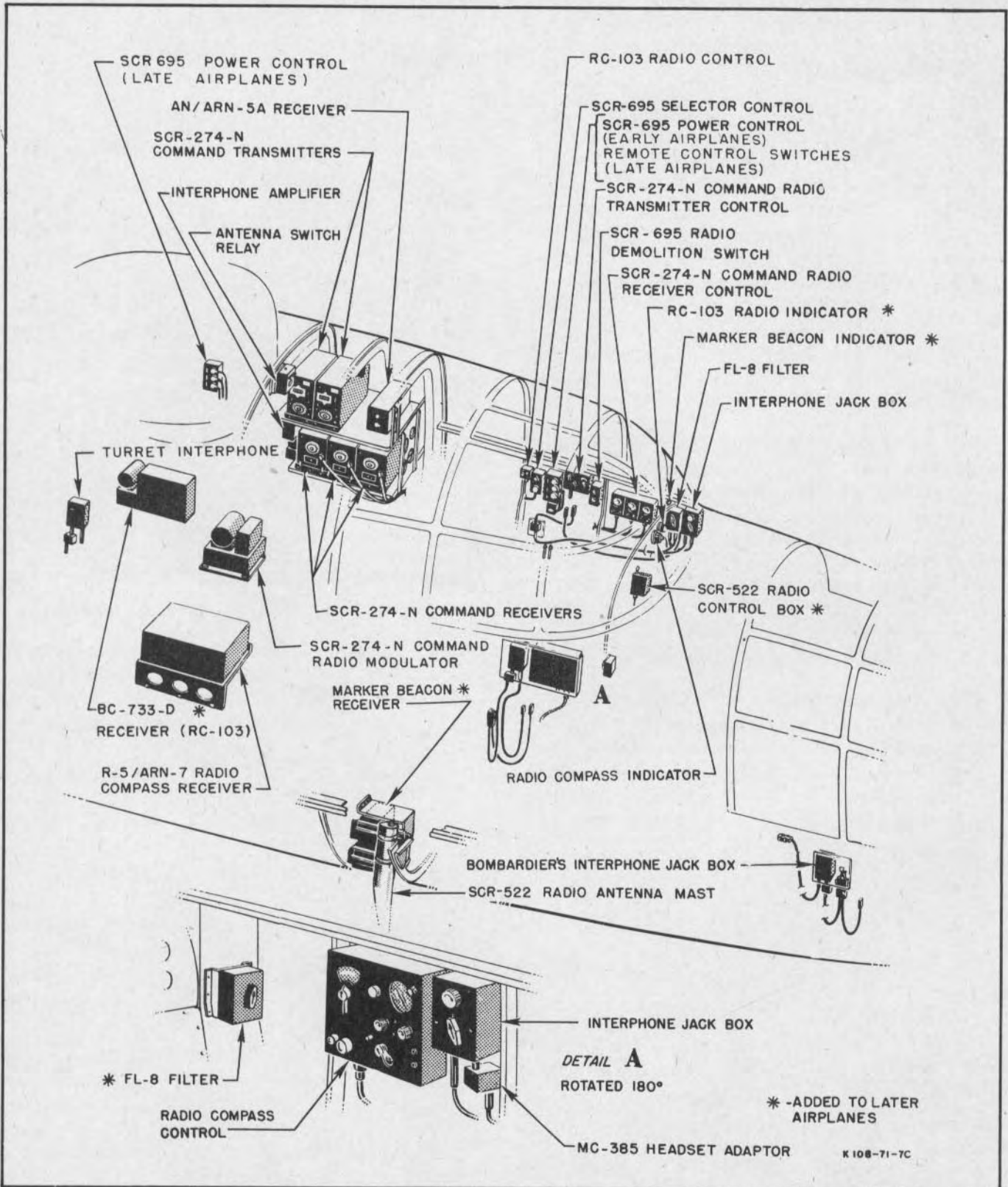

Figure 43—Radio Equipment—Front Section

No spare coils are required for either the transmitters or the receivers.

1. TRANSMITTER.

a. Connect the headset and microphone to the proper plugs.

b. Place the "TRANSMITTER SELECTOR" in either position "1" or "2," depending on the frequency desired.

c. Select the type of emission desired, "TONE-CW-VOICE."

Note

With the switch placed in the "VOICE" position, the microphone, from any jack box switched to "COMMAND" position, will be operative, and voice will be transmitted when the push-to-talk switch is closed.

d. Place the "TRANS POWER" switch in the "ON" position.

e. A push button switch on each control wheel permits voice transmission; at all other stations, the push-to-talk microphone switch must be closed. Only the pilot may operate the transmitter on "CW" or "TONE."

2. RECEIVER.

a. Connect the headset to the proper jack.

b. Place the jack box switch on "COMMAND" position.

c. Select the receiver or receivers desired, then turn the switch, in the upper right corner, to either "MCW" for voice reception or to "CW" for code signals.

d. Place the switch in the upper left corner to "A" position.

e. Tune in the desired station, and at the same time adjust the "INCREASE OUTPUT" to the desired headset volume.

Note

During flight, all the receivers should be turned "ON." However, increase the volume only on the frequencies being guarded.

(b) SCR-522 COMMAND SET.

1. TRANSMITTER.

a. Connect microphone to the proper plug.

b. Push button "A," "B," "C," or "D" on control box, depending upon the band to be used.

c. Allow set approximately one minute to warm up.

d. Move the selector switch on jack box to "LIAISON" position.

Note

With the exception of the radio operator's jack, the SCR-522 radio set may be operated from any jack box when set in the "LIAISON" position.

e. If the transmit-receive toggle switch is not safetied in the "REM" (remote) position, move it to that position and lock in place with the lever just forward of the toggle switch. The transmitter can then be operated from the push-to-talk switch on each control wheel, or from any of the other stations.

Note

When the push-to-talk switch is released, a relay automatically shifts the set to the receive position.

2. RECEIVER.

a. Connect headset to proper jack.

b. Place the selector switch on jack box to "LIAISON" position.

c. Press "A," "B," "C" or "D" depending on which band is desired. Allow set approximately one minute to warm up. Reception of a signal will indicate whether the receiver is operating properly.

Note

As long as the transmit-receive toggle switch is in the "REM" position, the set will automatically cut back into receive position after transmission is made.

d. To turn set off, press button marked "OFF."

(c) SCR-570 RADIO SET.

1. OPERATION.

a. When approaching landing strip, turn the ON-OFF switch to "ON" position.

b. Turn selector switch on jack box to "COMMAND" position.

c. Turn frequency selector switch or "LOCALIZER" to the frequency of the transmitter on the landing strip.

d. Turn "INCREASE VOLUME" knob to the desired position.

e. VERTICAL GUIDANCE.—The horizontal bar indicates the proper angle of descent. When the horizontal bar and vertical bar are in direct line with the dotted lines, the airplane is in line with the landing strip and is descending at the proper angle for a normal landing. The proper landing direction and instructions for a particular field should be obtained from the control tower or the operations officer before take-off.

Note

If glide-path transmitter signals are not being radiated within the range of the receiver, or if the incoming signal is interrupted, an automatic alarm in the receiver will cause the horizontal bar to deflect upwards and remain there, regardless of the aircraft heading, until the receiver comes within range of the transmitter. At the same time, an audible buzz will be heard in the headset.

f. LATERAL GUIDANCE. — When making an approach to the landing strip, the vertical needle will point in the direction toward which the heading of the airplane should be corrected. When the airplane is directly in line with the runway, the vertical needle will be centered. A deviation of $\frac{1}{4}$ -scale deflection to right or left of center is not too great for a safe landing.

Note

If the airplane is to right of the landing strip the vertical needle will swing to the left or "blue area," and a 150-cycle modulated tone will be heard in the headset. If the airplane is to left of landing strip, the vertical needle will swing to the right or "yellow area" and a 90-cycle modulated tone will be audible in the headset. In either case, limit the correction in heading to small angles to prevent losing the beam.

(d) IDENTIFICATION EQUIPMENT. — The radio set SCR-695 is placed in operation by turning "ON" the control switch. Allow 5 minutes for the set to warm up. Information concerning the selector switch, the emergency switch, and the G-band switches can be obtained from the communications officer in charge. To stop the equipment, turn "OFF" all switches.

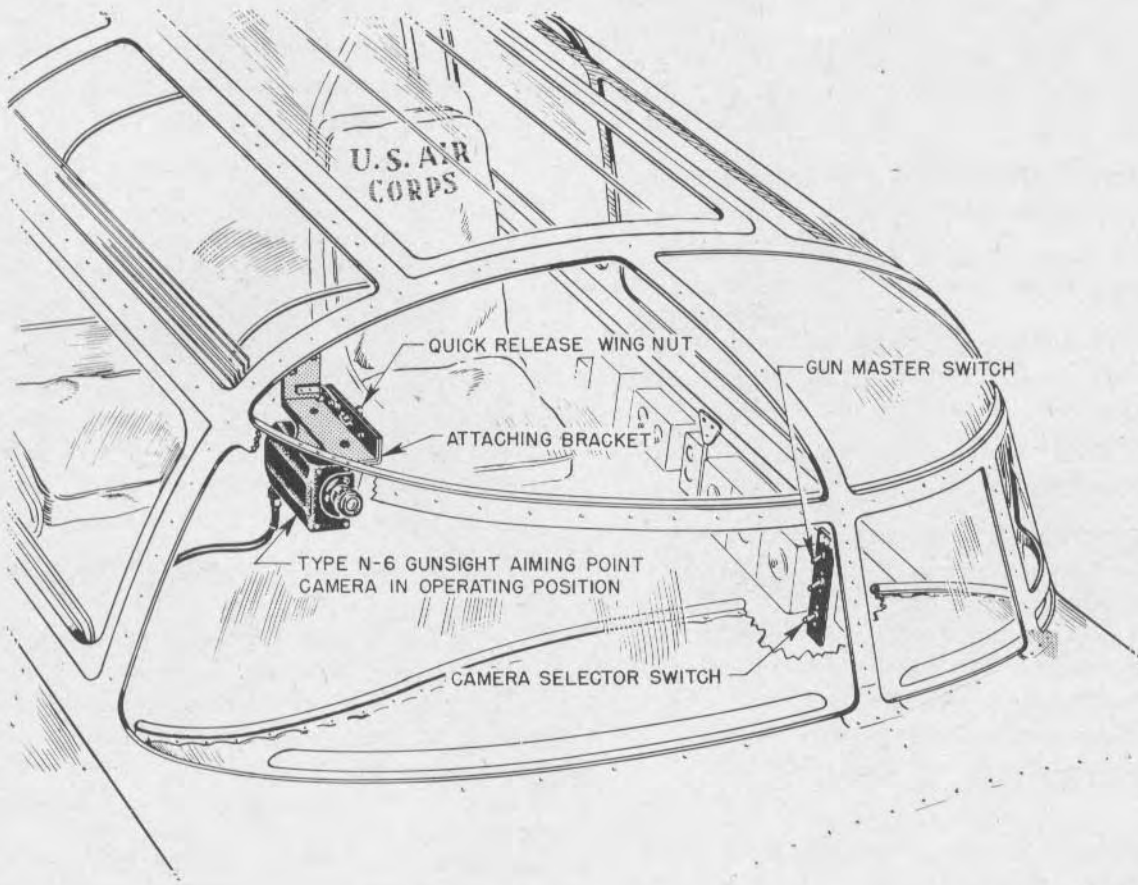

K 108-66-1A

Figure 44—Gun Camera Equipment

WARNING

The destructor plug is to be inserted only when the airplane is ready to take off, and must be removed immediately after the airplane has landed.

The dual push-button switch marked "DANGER" is pressed when the airplane is to be abandoned over enemy territory. The buttons must be pressed simultaneously. The destruction of the set will not harm the airplane.

(e) RANGE FILTER.—The radio range filter has three positions. Position 1, marked "RANGE," permits the reception of the range signal only. Position 2, marked "VOICE," permits the reception of the voice-given weather reports only. Position 3, marked "BOTH," permits the reception of both the range signals and the voice-given weather reports.

NOTE

The range signal referred to above is the beacon signal of the simultaneous range setup, in which weather reports are broadcast on the same frequency as the beacon signal.

g. CAMERA.

(1) MANUAL OPERATION.—To operate the camera manually, proceed as follows:

(a) Ask the waist gunner to set the intervalometer at the desired shutter speed.

(b) Depress the camera switch, on the left side of the pilot's switch panel, to the "MANUAL" position. The switch is spring-loaded to return to the "AUTO" position when it is released.

b. GUN CAMERA.

(1) DESCRIPTION.—On late airplanes a Type N-6 gun sight aiming point camera is mounted on a bracket in the upper right-hand corner of the pilot's compartment (see figure 44). The camera sights through the copilot's windshield and is attached to the mounting bracket by means of a snap-on fitting which permits removal of the camera at any time without affecting the bore sight alignment. A camera selector switch is at the bottom of the gun control panel.

(2) OPERATION.—To operate the camera in conjunction with the fixed guns, proceed as follows:

- (a) Turn camera selector switch "ON."
- (b) Move gun master switch to "FIRE."
- (c) Depress gun trigger switch on control wheel.

NOTE

The gun camera may be operated independently of the guns by turning the camera selector switch "ON" and depressing the gun trigger switch.

i. HEATING, VENTILATING, AND DEFROSTING.

(1) GENERAL.—Operation of the heaters on both early and late airplanes is controlled by a master switch on the pilot's switch panel. This switch is for emergency use and provides a means by which the pilot will keep the heaters from operating during take-off and landing. On late airplanes, the forward heater may be operated on the ground. A hot air outlet is located just forward of the control pedestal, and a flexible defroster tube is located on the floor at the right side of the lower pedestal. Heat is also directed, by means of manual controls, to the windshield defroster panels. There is a ventilator at each side of the compartment, just aft of the instrument panel. Hot air outlets may be used for ventilation as well as heating.

(2) OPERATION.

(a) LATE AIRPLANES.

1. Turn master cabin heat switch on pilot's switch panel to "ON."
2. Turn heater switch on pilot's switch panel to "START & HIGH."
3. Push in on fuel pressure switch button on pilot's switch panel until light above switch button goes out, then release button.

NOTE

If light remains illuminated while pressing button, or illuminates after heater has been started, it is an indication that the fuel pressure safety switch in the system has shut off the fuel supply to the heater because of a line leakage.

4. If less heat is desired, turn heater switch to "LOW."
5. Set heating system push-pull controls on instrument subpanel, as desired, to direct warm air to the floor outlet, auxiliary defroster tube or windshield defroster. If desired, the entire heat output may be directed to the pilot's compartment.

NOTE

On airplanes with the forward heater only, a heater blower switch is mounted on the pilot's switch panel, in place of the master cabin heat switch. If heater is to be operated on the ground, it is necessary to turn blower switch "ON." After take-off, turn blower switch "OFF."

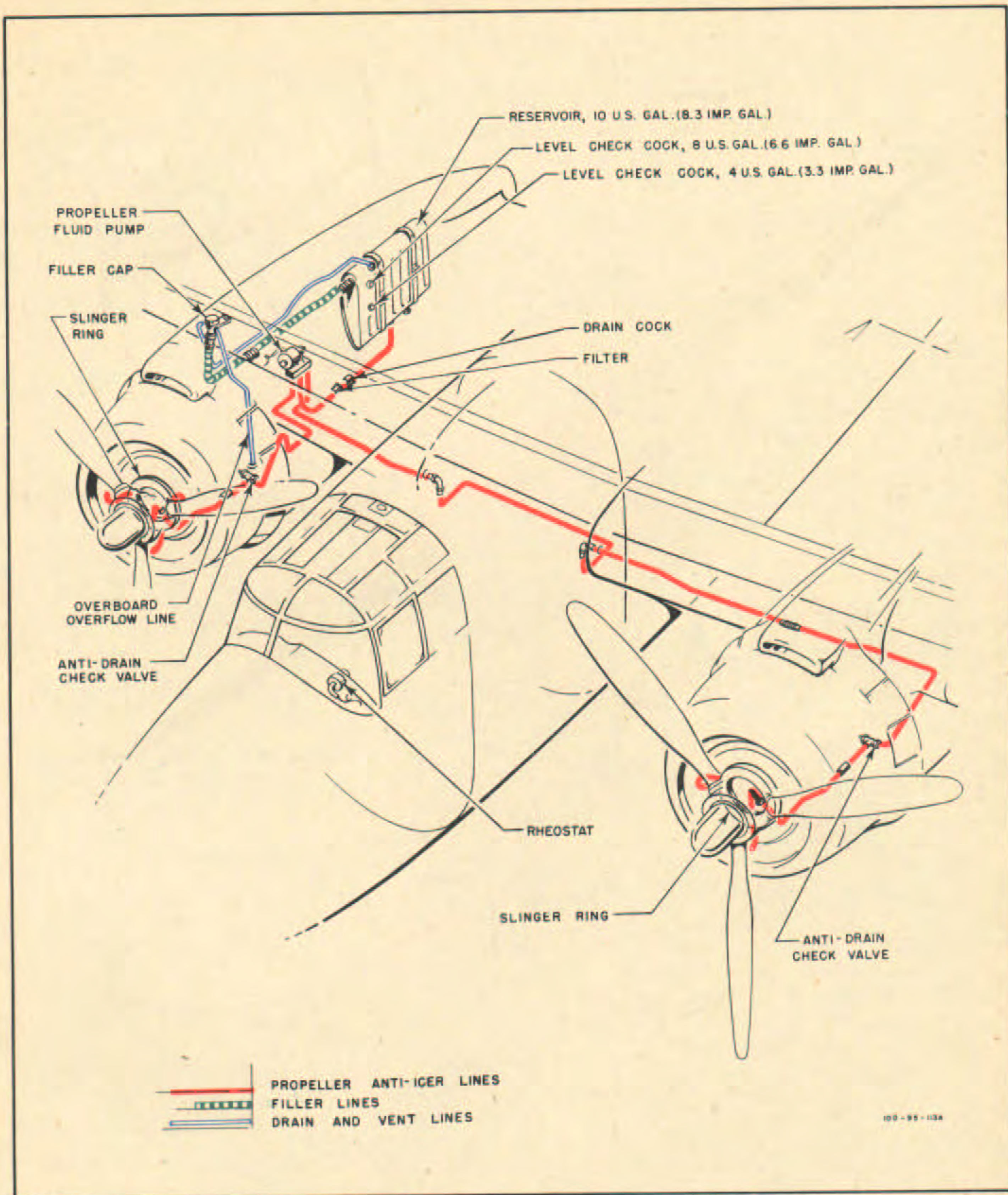

Figure 45—Propeller Anti-icer System

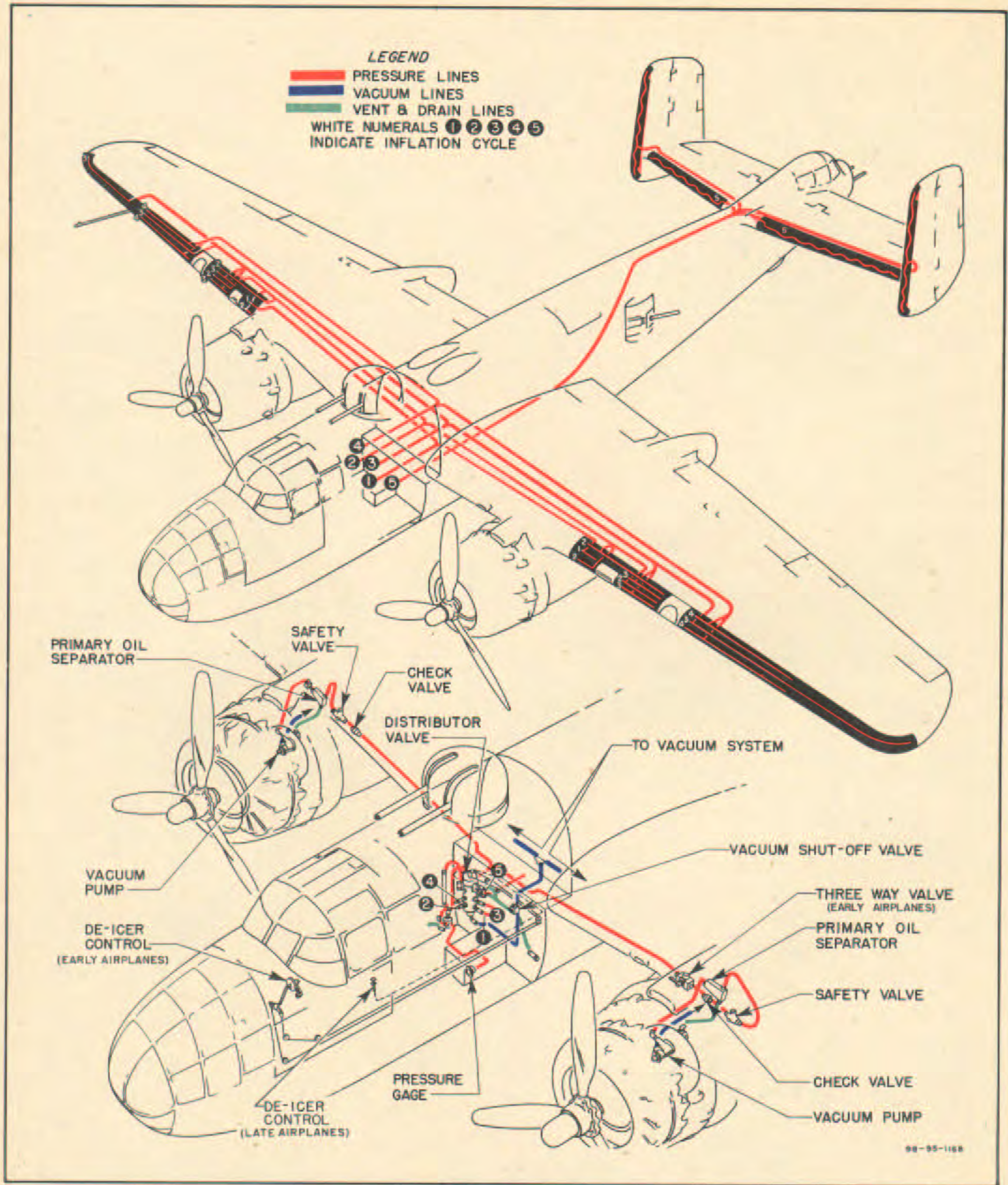

Figure 46—Surface De-icer System

(b) EARLY AIRPLANES.—Operation of the pilot's heating and defrosting equipment is as follows:

1. CABIN AIR.—This control is below the control pedestal switch panel on the left side. Pull "OUT" to admit hot air; push "IN" to shut off hot air.

2. CABIN AND WINDSHIELD DEFROSTERS.—Turn "ON" defroster blower switch on pilot's switch panel. Pull "OUT" control, located on right side of control pedestal, to direct heated air through flexible defroster tube; push control "IN" to defrost windshield.

j. PROPELLER ANTI-ICER SYSTEM.

(1) DESCRIPTION.—The propeller anti-icer system consists of an alcohol fluid tank, electric pump, and propeller anti-icer slinger rings. Leading edge feed shoes for the propeller blades will be installed in the field as they are needed. The system distributes alcohol along the leading edges of the propeller blades to prevent the adhesion or accumulation of ice on the propellers. The system is operated by a rheostat control on the pilot's switch panel.

(2) OPERATION.—If ice starts to form on the propellers, turn rheostat control "ON." By adjusting the control to various positions, the amount of anti-icer fluid being delivered to the propellers may be varied.

k. SURFACE DE-ICER SYSTEM.

(1) DESCRIPTION.—The flight surface de-icer system consists of inflatable rubber shoes on the leading edges of the wings and empennage, inflated from the pressure side of two engine-driven vacuum pumps. During flight, when the system is not in operation, vacuum pump suction prevents the negative air pressure on the airfoils from raising the de-icer shoes. The de-icer shoes will be installed at the discretion of the AAF.

(2) OPERATION.—If ice starts to form on the leading edges of the wing and empennage, turn surface de-icer control handle on left side of pilot's compartment to "ON."

CAUTION

Do not operate de-icer during landing or take-off.
Do not operate de-icer system at speeds above 230 mph IAS.

NOTE

An emergency shut-off valve near the distributor valve in the upper turret compartment is used to prevent loss of instrument readings in the event of de-icer system failure.

2. BOMBARDIER.

a. BOMBING EQUIPMENT.

(1) DESCRIPTION.—The bomb control panel, on the left side of the bombardier's compartment, incorporates bomb station indicator lights, a bomb nose fusing switch and its indicator light, a bomb system master switch, a bomb door control switch, and a bomb salvo switch (see figure 48). On late airplanes, bomb rack selector switches are mounted on the panel (see figure 47) to provide selective release of bombs from the bomb bay racks or the wing racks, if installed. The bomb release switch is stowed to the left of the bomb sight mount. The Type B-3 bomb interval control is mounted above and forward of the bomb control panel. The bombardier's instrument panel, containing a remote compass indicator, an airspeed indicator, and an altimeter, is mounted on the left side of the compartment. A free air temperature indicator is located above the panel.

(2) OPERATION.

(a) INOPERATIVE POSITION OF CONTROLS.—When the bomb controls are not in operation, position them as follows:

1. Master switch "OFF."
2. Nose fusing switch "OFF."
3. Bomb bay doors closed with bomb door control switch in neutral.

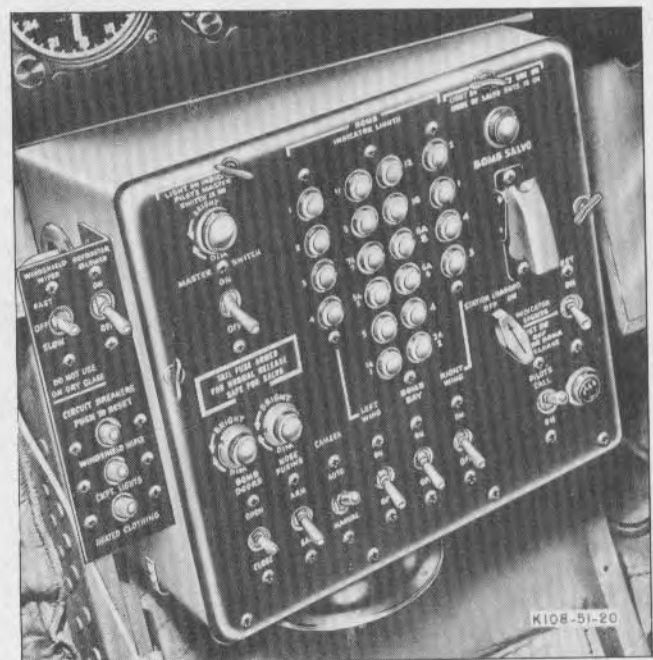

Figure 47—Bombardier's Control Panel—
Late Airplanes

NOTE

On early airplanes (prior to 43-35984) bomb indicator lights for the BOMBARDIER'S CONTROL PANEL (Fig. 48) and PILOT'S CONTROL PANEL (Fig. 36) have bulbs mounted in only one panel, usually the pilot's. If it is desired to use lights on alternate panel it is necessary to transfer the bulbs to this panel. Never fit both panels with

bulbs as the electrical bombing system does not have sufficient power to operate both sets. On later airplanes (after 43-35984) bomb indicator lights and test switches are mounted on BOMBARDIER'S CONTROL PANEL (Fig. 47) and not on the PILOT'S CONTROL PANEL (Fig. 37).

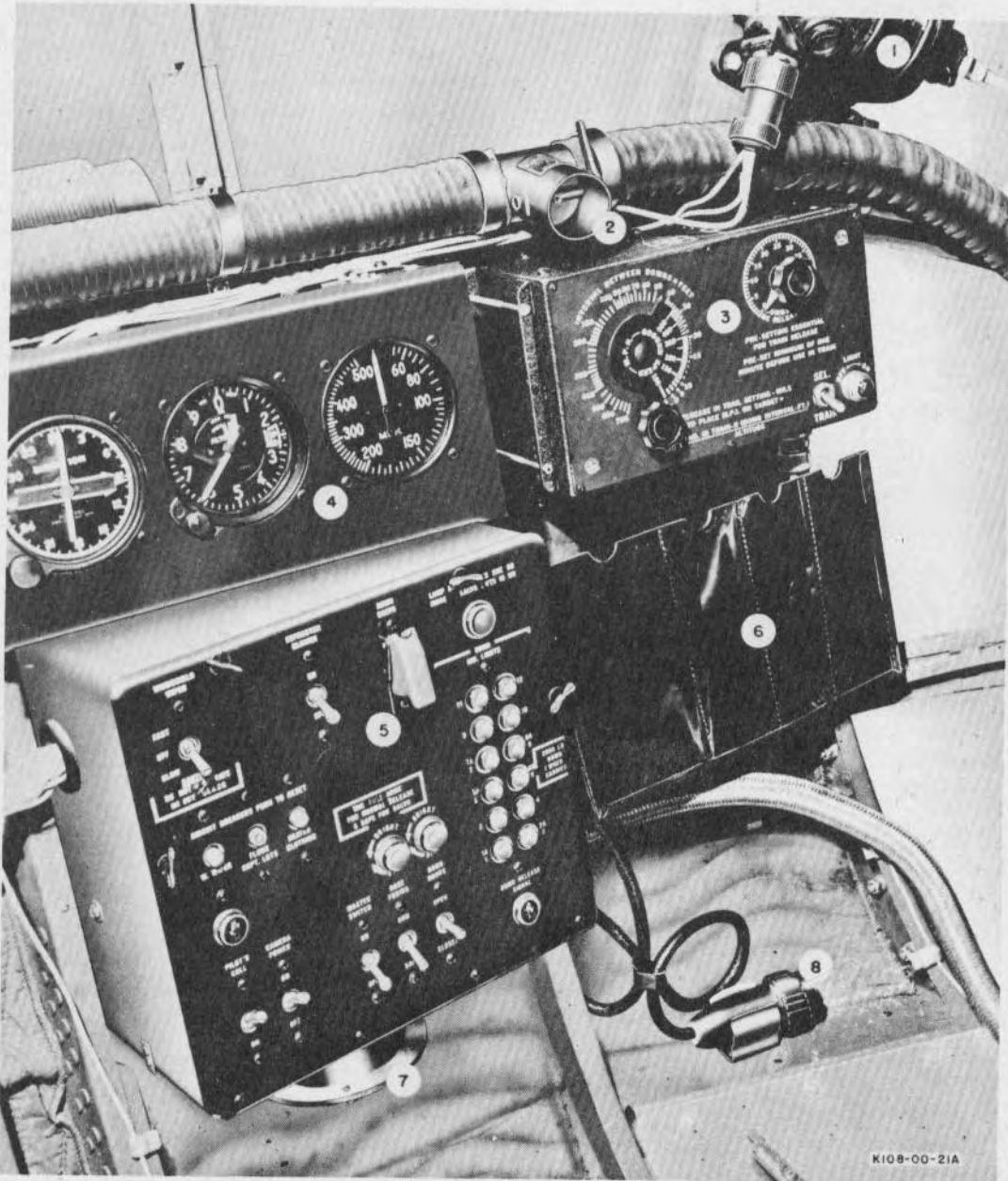

Figure 48—Bombardier's Controls

4. Guard down over bomb salvo switch.
5. Train-selective switch in "TRAIN" with counter dial at "0."

(b) TRAIN RELEASE.

1. Turn bomb master switch "ON."
2. Nose fusing switch "ON" if desired.
3. Set train-selective switch to "TRAIN."
4. Set interval selector dial to position which will give the desired spacing of bombs at the ground speed which the airplane is traveling.
5. At least two minutes prior to operation of the bomb interval control, place the counter dial on the setting corresponding to the number of bombs to be released.
6. Move bomb door control switch to "OPEN."
7. When bomb door position indicator light illuminates, press bomb release switch. A momentary pressure on the bomb release switch will suffice to release all the bombs for which the counter is set.

Note

To stop a train of bombs before the total number of bombs selected has been dropped, return the interval control counter dial to "0" or switch the train-selective switch to "SEL."

8. When all bombs have been released, move bomb door control switch to "CLOSE." After doors have been closed, return switch to neutral.
9. Return bomb controls to their inoperative positions.

(c) SELECTIVE RELEASE.

1. Turn bomb master switch "ON."
2. Nose fusing switch "ON" if desired.

KEY TO FIGURE 48

1. Windshield Wiper Motor
2. Defroster Tee
3. Bomb Interval Control
4. Bombardier's Instrument Panel
5. Bomb Control Panel
6. Bomb Chart Holder
7. Warning Horn
8. Bomb Release Switch

3. Train-selective switch in "SEL."
4. Move bomb door control switch to "OPEN."
5. When bomb door position indicator light illuminates, press bomb release switch once for each bomb to be released.
6. Turn bomb door control switch to "CLOSE." When doors have closed, return switch to neutral.
7. Return bomb controls to their inoperative positions.

(d) SALVO RELEASE.—To release bombs in a salvo, move antisalvo guard aside and actuate bomb salvo switch. All bombs will be released simultaneously without positioning any other control. After racks are salvoed, move salvo guard down. To close doors, turn "ON" bomb master switch and turn bomb door control switch to "CLOSE." After doors are closed return switch to neutral, turn "OFF" bomb master switch, and put guard in place over the salvo switch.

Note

The indicator light test switch and station loading switch must be "OFF" in order to release bombs. If over enemy territory, turn bomb master switch and nose fusing switch "ON"; all bombs will drop in a salvo armed. If over friendly territory, have nose fusing switch "OFF"; all bombs will drop in a salvo unarmed.

IMPORTANT

Always have the bomb racks checked after all bombs have been released, to make sure no bombs are hung up on the racks.

(e) EMERGENCY OPERATION.—For emergency operation of the bombing equipment, see Section IV, paragraphs 10, 11, and 12.

b. GUNNERY EQUIPMENT.

(1) DESCRIPTION.—A flexible .50-caliber gun is mounted in the forward end of the bombardier's compartment. The gun is provided with three ammunition boxes with a total capacity of 300 rounds. Bungees connected to the gun by shock cord aid the maneuverability of the gun.

(2) OPERATION.

(a) PREPARATION FOR FIRING.

1. Release gun from stowed position by pushing plunger on aft end of gun adapter.

2. Charge gun by pulling back and releasing charging handle.

3. Move safety to "FIRE."

(b) FIRING GUN.

1. Sight through ring-and-bead sight and fire gun by pulling trigger.

2. After firing, move safety to "SAFE" and stow gun.

3. COPILOT-NAVIGATOR.

a. NAVIGATION EQUIPMENT.

(1) DRIFTMETER OPERATION.

(a) The driftmeter is stowed in a bracket at the top of the upper turret gunner's compartment. In operation, the driftmeter is attached to the right side of the fuselage where there is a sighting port for it.

(b) Look through the eye lens and rotate the reticle control until the drift lines are parallel to the apparent line of motion of objects on the ground. When over land or water on which there are few prominent or readily identifiable objects, keep the eye fixed on the reticle and observe the general movement of the background without attempting to follow any one ground object. The pointer on the drift dial will then show the drift of the aircraft to the left (plus) or to the right (minus).



Figure 49—Pyrotechnic Pistol

(c) The driftmeter may be operated by use of the pantograph pointer instead of the reticle lines. With the point of the needle visible in the eye lens and a pencil in the pantograph holder, follow, by means of the pantograph system, the movement of an object (on the ground) across the field of the eye lens. The pencil will leave a line on the ground glass. Then move the indicator knob of the reticle control until the parallel lines align themselves with the line drawn on the ground glass plate. The pointer on the drift scale will then indicate the drift to left or right.

(d) To determine ground speed, the altitude of the airplane must be known and the airplane must be kept in level flight while a reading is taken. Set the reticle lines of the driftmeter by determining the existing drift of the aircraft. With a stop watch, check the time required for an object on the ground to cross the eye lens field from one timing line to the other. Then locate the time in seconds on the dial of the computer and set reading against the height of the airplane on the height scale. The ground speed in miles per hour will be indicated by the black line on the dial marked "MPH," and the speed in knots by the red line marked "KNOTS."

(2) RADIO COMPASS.

(a) DESCRIPTION.—The radio compass, SCR-269 or AN/ARN-7, consists of a receiver, a control box, an azimuth indicator, a rotatable loop, and accessories for interconnection of the units. The radio compass receiver is on the floor of the upper turret gunner's compartment, and the control box is at the right of the copilot's seat. The azimuth indicator is mounted on the upper left side of the pilot's instrument panel. The loop is mounted on the forward part of the fuselage below the pilot's compartment.

(b) OPERATION.

1. Turn on radio compass receiver by moving switch on remote control box to "COMP," "ANT," or "LOOP." With the switch turned to "COMP," both the rotatable loop and the fixed antenna are in use; in the position marked "ANT," only the fixed antenna is in use; and with the switch turned to "LOOP," only the rotatable loop is in use.

2. Select frequency band desired by rotating the band switch control to one of its three marked positions.

b. BLISTER GUNS.—Charge the blister guns by pulling out and releasing the charging handles.

c. PYROTECHNIC RECOGNITION SIGNAL PISTOL.—An M-8 type pyrotechnic pistol is stowed behind the pilot's seat or on the left side of the upper turret compartment. For use, it is placed in the mount immediately

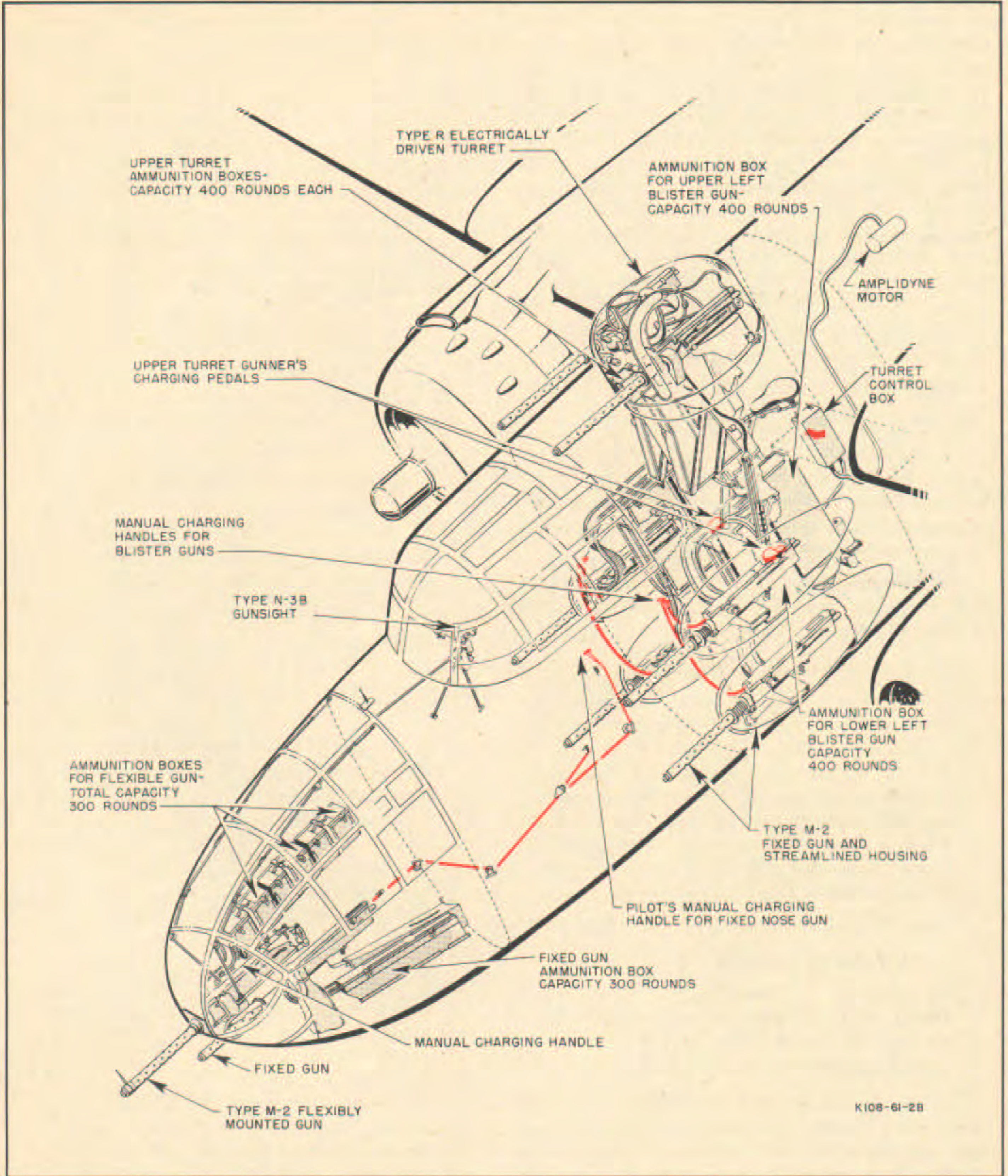

Figure 50—Gunnery Equipment—Front Section

ft and above the copilot's seat, or, on late airplanes, on the right side of the upper turret compartment. The pistol is installed in the mount by removing the friction-type cover cap and inserting the muzzle so that the lugs fit into the slots, then turning the pistol to right or left as far as it will go while depressing the mount release trigger above the pistol barrel. The pistol may then be loaded by moving the breech lock lever, behind the mount release trigger, and applying force on the butt until the breech opens; then inserting the signal into the chamber and closing the breech, which automatically cocks the pistol.

WARNING

As no safety is provided, the pistol should not be loaded except when it is in the mount.

4. UPPER TURRET GUNNER.

a. UPPER TURRET.

(1) DESCRIPTION.—The Bendix Model R upper turret is electrically powered and amplidyne controlled, and is equipped with two flexibly mounted .50-caliber guns and a 400-round ammunition box for each gun, and a Type N-6A optical gun sight.

(2) OPERATION.—Before firing upper turret guns, have pilot make certain that spring lock is installed on pilot's escape hatch release handle.

WARNING

Do not operate the turret without an adequate power supply. If the voltage supply at the turret drops below 20 volts, serious damage to the turret or to the airplane may result. When the turret is operated on the ground, the airplane engines should be running, or an external power supply which provides a constant 28-volt supply should be used. Operation of the turret on the airplane batteries should be kept to an absolute minimum.

(a) PREPARING TURRET FOR OPERATION.

1. Adjust the footrests and seat.

Note

Do not step on the azimuth motor, brush box, or the electrical conduit when taking position or descending from the turret.

2. Turn on the turret main power switch. Turn on the switch to supply the heated clothing unit, extension light, and gun sight. These switches are located in the left side of the airplane in the turret power control box.

Turn on the gun sight switch on the gun sight and adjust the intensity with the rheostat.

3. To heat the clothing, connect the plug of the heated clothing wire to the outlet in the rheostat outboard of the right control handle; then place the control to the lowest setting required for comfort. Maintain the heated clothing at the lowest temperature necessary for comfort, as perspiration caused by excessive heat at medium outside temperatures produces a chilling effect when lower temperatures are reached. The proper amount of heat is being used when the wearer is not conscious of external heat except possibly on the abdomen and the back of the hands.

4. Plug in the microphone and headset circuits and turn the jack box knob to the desired position.

5. Charge the guns by raising the footrest pedals with the toes until they latch, and then press the pedals down to the footrest position. Use this same method for removing a faulty cartridge during firing.

(b) COMBAT OPERATION.

ANGER

Do not depress the trigger firing switches on the control handles, as the guns are operative as soon as the main power switch is turned on.

1. The turret can be rotated continuously (360°) in azimuth, and the guns swing from almost straight up to one degree below horizontal. The speed of the turret can be varied from 1/4° to 12° per second in low speed, and from 1/4° to 33° per second in high speed. The gun firing circuit

KEY TO FIGURE 51

1. Interphone Buttons
2. Safety Switches
3. Trigger Switches
4. Gun Control Handles
5. Extension Light
6. Fuel Transfer Control
7. Fuel Cross-feed Control
8. Turret Seat
9. Gun Charger Pedals
10. Emergency Fuel Pump Handle
11. Riding Seat
12. Signal Lamp Case
13. De-icer Vacuum Shut-off Valve
14. Turret Handcrank
15. Interphone Jacks
16. Armor Plate
17. Heated Clothing Rheostat
18. Hydraulic Reservoir

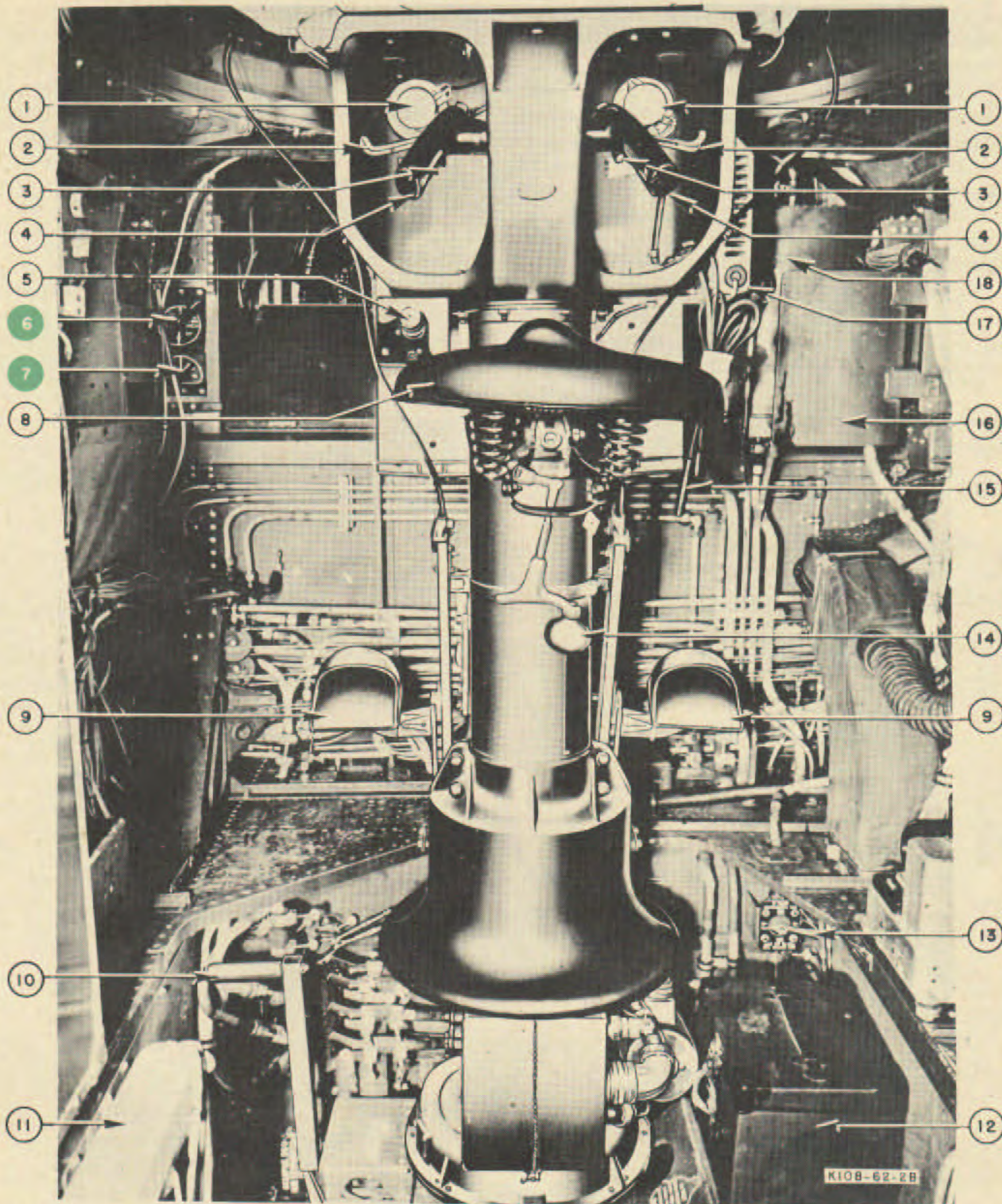

Figure 51—Upper Turret

cuts out individually for each gun to prevent it from firing into the propellers, vertical stabilizers, and the tail turret enclosure.

2. To rotate the turret in azimuth, rotate the control handles clockwise or counterclockwise about the vertical axis. The turret moves in the same direction as the handles. Movement of the guns in elevation follows the up or down movement of the control handles. The speed of rotation of the turret and guns is proportional to the degree of rotation of the control handles from the neutral position. For fast slewing speed in azimuth or elevation, press the high-speed switch on either control handle.

3. Grip the control handles and depress the safety switches. As the switches are wired in parallel, it is not necessary to have both depressed.

4. Look through the sight to train the guns on the target. The dot in the center of the reference circle indicates the point on which the guns are trained.

5. To fire the guns, press the trigger switch on either control handle.

6. When the turret is not in use, return the guns to a horizontal position and point them straight aft. Then turn off the turret main power switch. Have pilot unfasten spring lock on pilot's escape hatch release handle.

Note

In an emergency, the guns can be stowed manually as described in Section IV, paragraph 9. *a*.

b. HEATING AND VENTILATING SYSTEM.

(1) EARLY AIRPLANES.

(*a*) STARTING HEATER.

1. Close the airflow control and set heater control in "OFF" position.

2. Ask pilot to set master cabin heat switch on pilot's switch panel to "ON," and to maintain the left engine manifold pressure at approximately 27 in. Hg.

3. Move heater control to "ON."

4. After heater starts, adjust heater control and airflow control to obtain desired heat delivery.

5. Adjust control on duct to obtain proper heat in compartment.

Note

If heater does not start in 1 to 3 minutes (cold outside air temperature may require a longer starting period), move heater control further toward full "ON" position. Moving the heater control back and forth may also aid in starting. If the heater still does not start, ask the pilot to

vary the manifold pressure and mixture setting. The heater will start and operate better on a lean mixture. In extremely cold weather, leave the airflow control in closed position at all times, regardless of altitude and airspeed. If heater goes out at high manifold pressures, it may be restarted by reducing manifold pressure and repeating starting procedure. If heater continues to go out at high manifold pressures, try retarding the heater control towards "OFF" so as to decrease the flow through the heater.

(*b*) VENTILATION.—The heating duct system may be used for ventilation when the heater is not operating by simply opening the airflow control for the desired amount of cold air.

(2) LATE AIRPLANES.—The upper turret heater (when installed) is turned on by the heater switch on the generator control panel. As the upper turret heater is identical to the aft compartment heater, see paragraph 5. *d*. for operating instructions.

c. ELECTRICAL EQUIPMENT.

(1) GENERATOR CUTOUT SWITCHES.—The generator cutout switches on the generator panel on the right side of the upper turret gunner's compartment must be turned "ON" during engine run-up or while the airplane is in flight. This allows the reverse-current relay to cut the generator into the electrical load when the generator output reaches between 26 to 27 volts. In an emergency or before a forced landing, turn the switches "OFF." Doing this in flight will prevent any further damage to the generator and the discharging of the battery into the generator, and will also greatly minimize any possibility of fire in case of a crash landing.

Note

During one-engine operation or should one generator fail, it is important not to draw more than 200 amperes from the one generator still operating. If possible, keep the load below this figure to prevent the generator from overheating and eventually failing.

The batteries are adequate only for a flight of short duration, and then only if they are in a properly charged condition and all electrically operated equipment not essential in flight is turned off so as to conserve battery power.

(2) GENERATOR AMMETERS.—During long flights, if the batteries have become fully charged and there is little load in the electrical system, the ammeter readings for the generator may be low. This is a normal condition

and does not indicate that the generator, regulator, or reverse-current relay is faulty.

(3) INVERTER SWITCH.—An inverter switch is located on the generator control panel. As the switch controls the alternating current to various items, it is imperative that this switch be "ON" at all times except when testing, or in an emergency.

d. SIGNAL LIGHT.—The Type C-3A signal lamp is stowed over the radio compass receiver in the upper turret gunner's compartment. The lamp is provided with four filters for various signaling operations: red, green, amber, and neutral gray. The gray filter, for night signaling, cuts the light to approximately 10% of its original intensity. Plug the lamp into the 24-volt outlet on the right side of the upper turret compartment or into the heated clothing rheostat. The lamp, a sealed-beam quick-signaling type, is controlled by a trigger switch on the handle. The lamp is aimed by means of sights at the top of the reflector.

5. WAIST GUNNER.

a. FLEXIBLE GUNS.

(1) DESCRIPTION.—Two flexible .50-caliber guns, one mounted in a plexiglas window at each side of the

fuselage aft of the bomb bay, are operated by the waist gunner. Each gun is provided with a 250-round ammunition box.

(2) OPERATION.

(a) Release gun from stowage position by pushing plunger on aft end of gun adapter.

(b) Charge gun by pulling back and releasing charging handle.

(c) Move the safety to "FIRE," and on late airplanes, turn "ON" gunsight rheostat, located on frame above the window.

(d) Fire gun by pulling trigger.

CAUTION

As the waist guns are not equipped with fire cut-off cams, be careful not to fire into the tail or nacelle.

(e) After firing, move the safety to "SAFE," stow gun, and turn "OFF" gunsight rheostat.

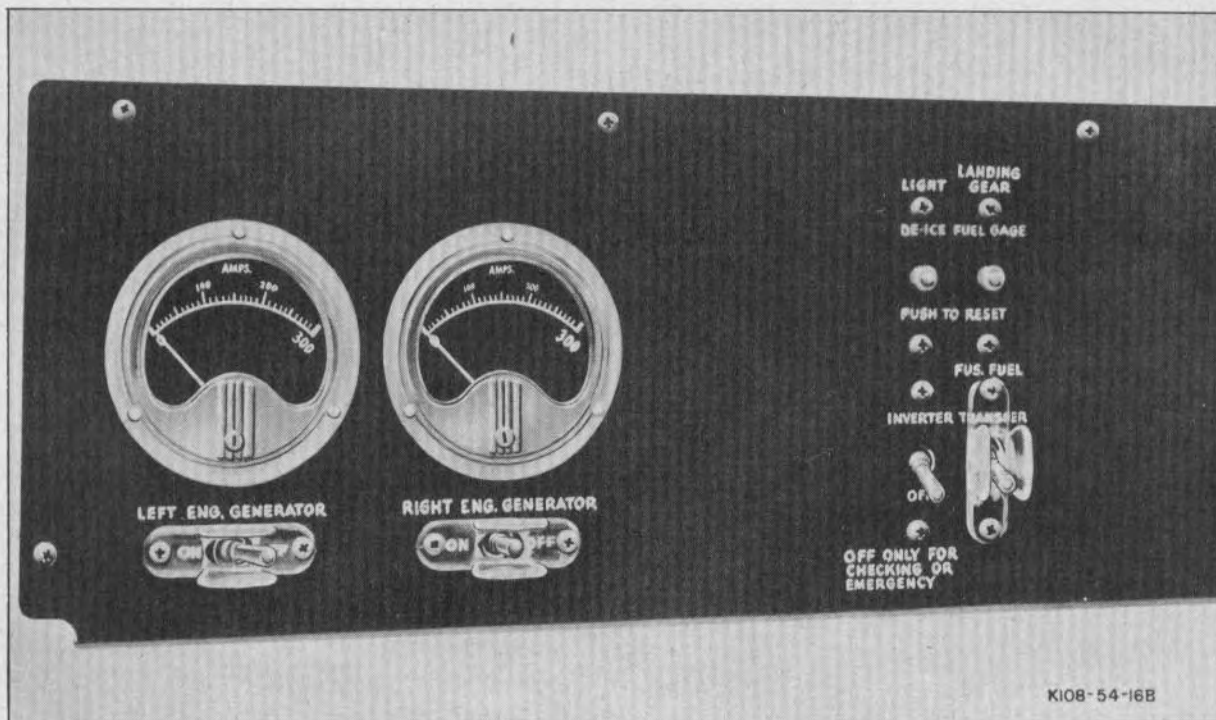
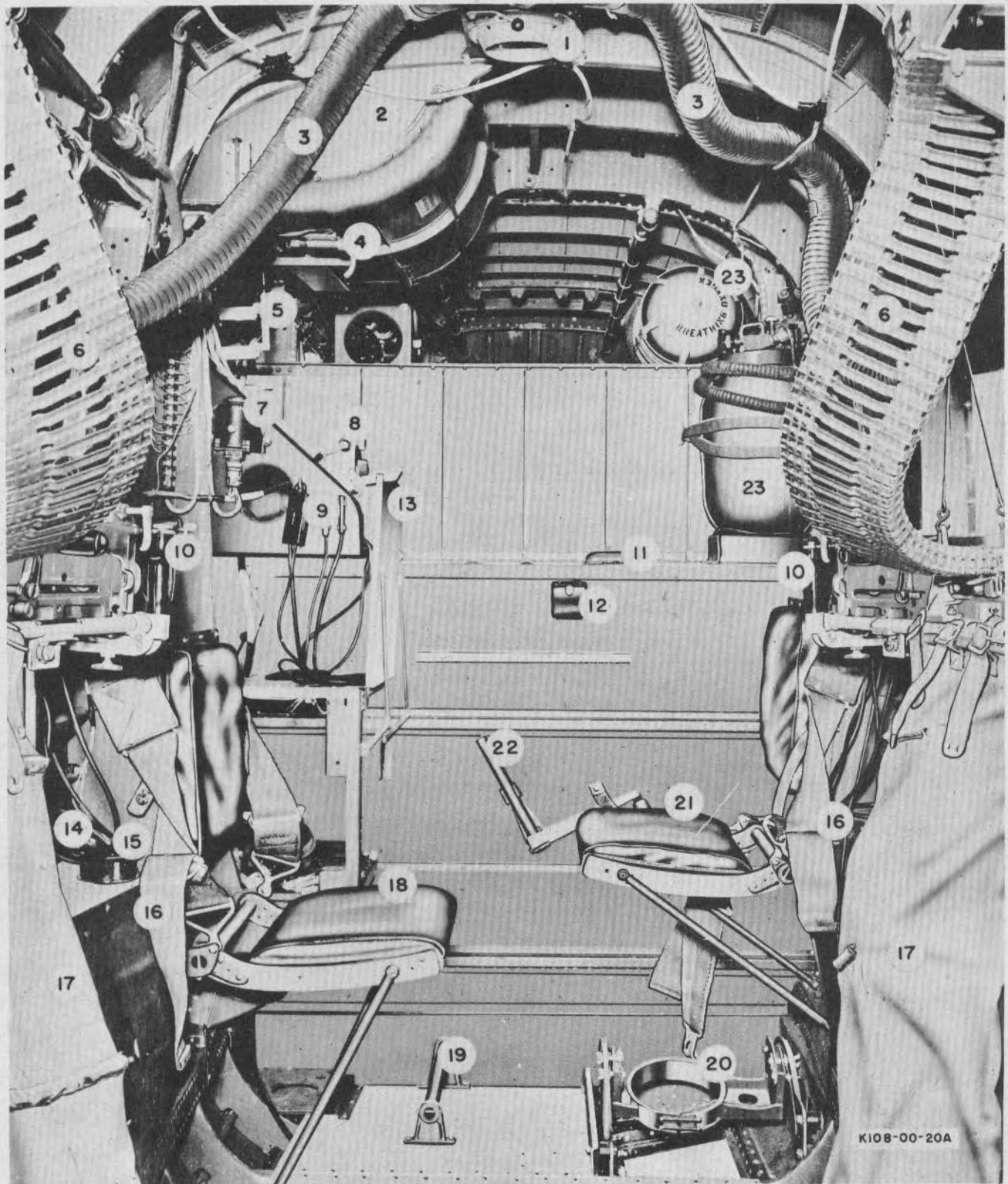

Figure 52—Generator Control Panel



K108-00-20A

Figure 53—Waist Gunner's Compartment—Forward View

1. Heater Duct Control
2. Life Raft Stowage
3. Defroster Tube
4. Life Raft Release Handle
5. Antenna Change-over Switch
6. Flexible Ammunition Chute
7. Impact Switch
8. Interphone Jack Box
9. Interphone Jacks
10. .50-cal. Waist Gun
11. Emergency Wing Flap Crank Access
12. Ash Tray
13. Folding Table
14. Ventilator
15. Alarm Horn
16. Safety Belt
17. Case and Link Ejection Bag
18. Tail Gunner's Riding Seat
19. Footrest
20. Camera Mount
21. Waist Gunner's Riding Seat
22. Emergency Wing Flap Lowering Crank
23. Portable Oxygen Unit

KEY TO FIGURE 53

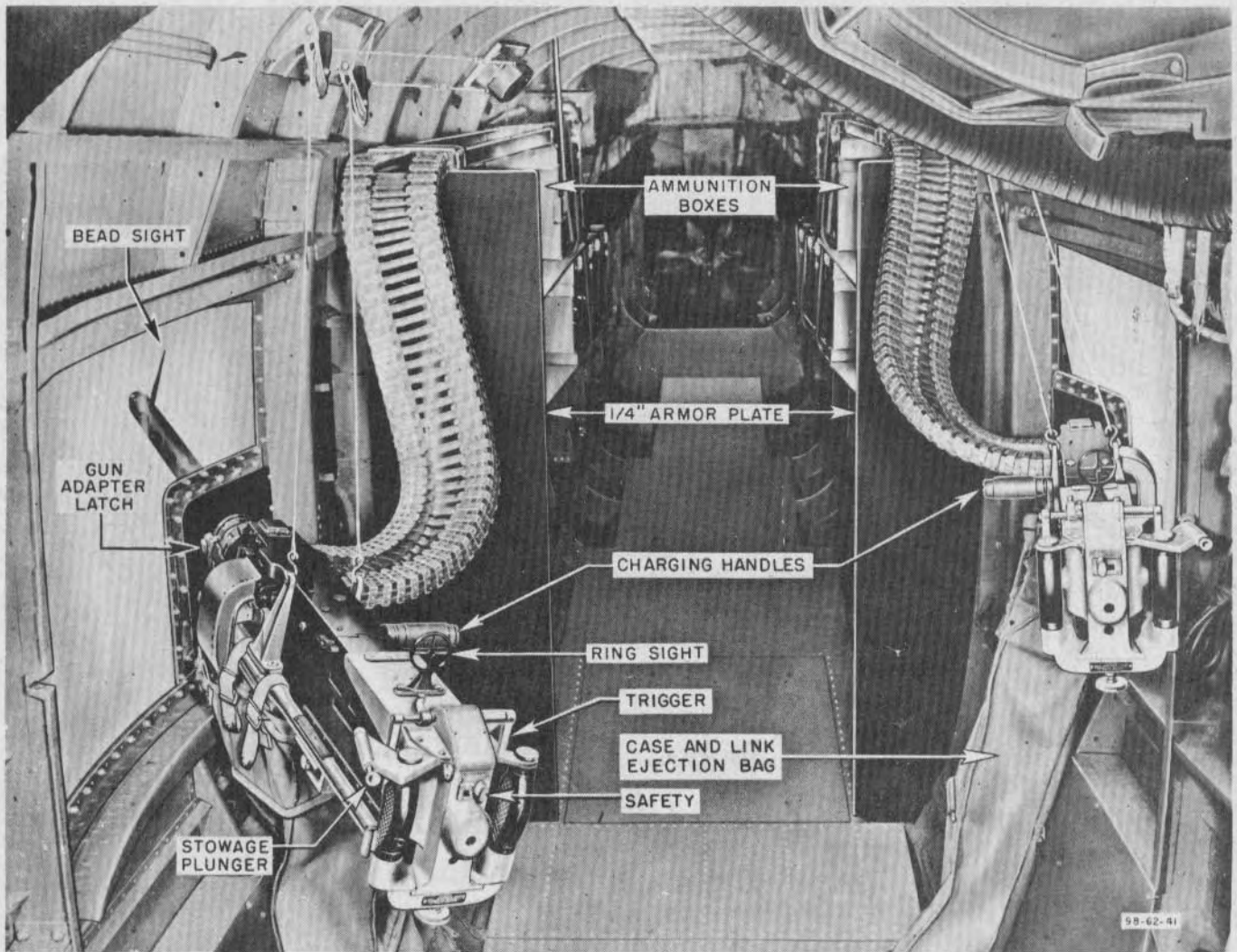

Figure 54—Waist Gunner's Compartment—Aft View

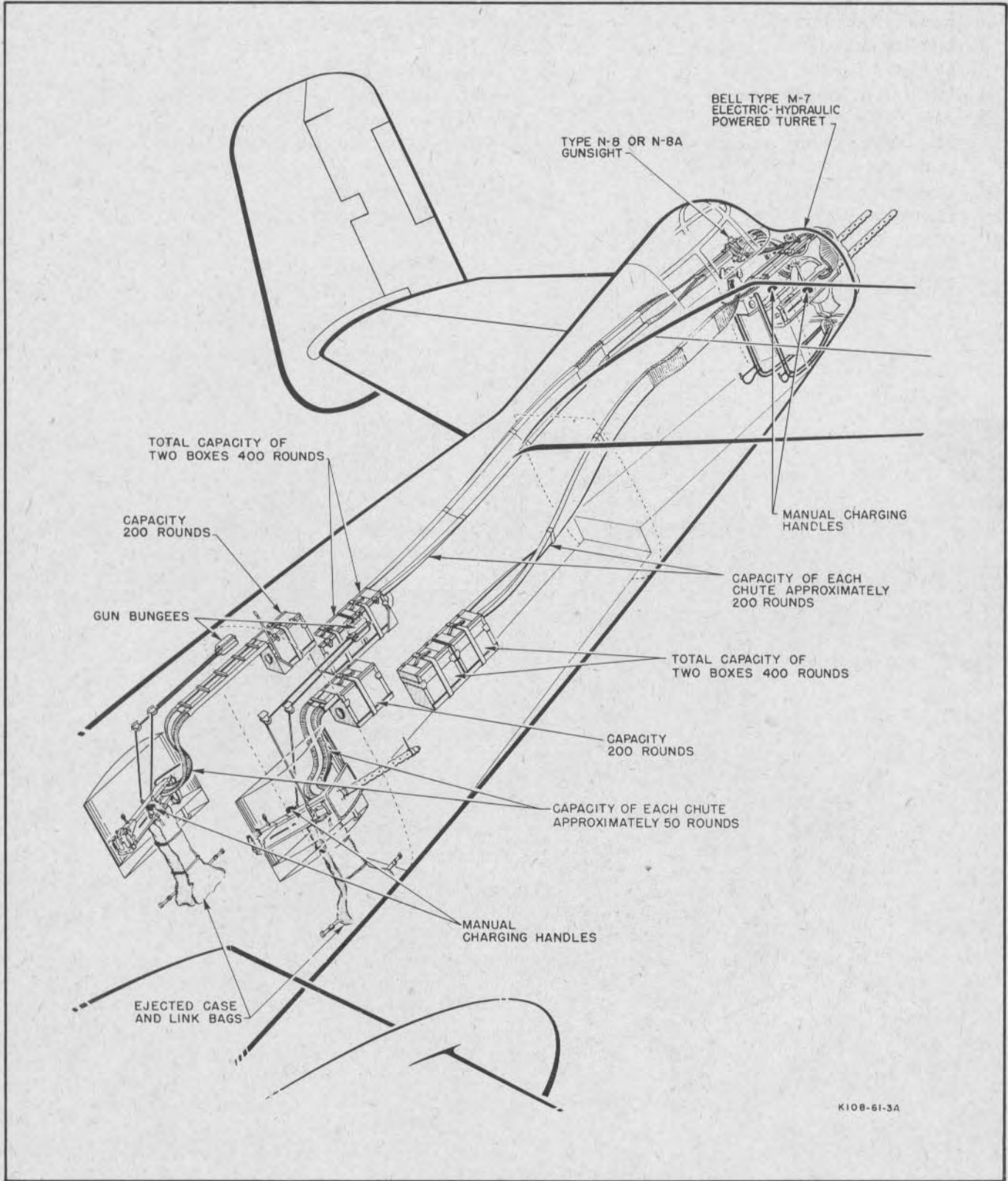

Figure 55—Gunnery Equipment—Rear Section

b. PHOTOGRAPHIC EQUIPMENT.

(1) DESCRIPTION.

(*a*) GENERAL.—The photographic station, in the fuselage immediately aft of the bomb bay, is provided with a single camera and a mount assembly. A long window in the floor of the fuselage permits camera swing over a wide angle.

(*b*) CAMERA.—The Type K-24 camera, which does not require vacuum pressure for its operation, is used. Roll film permits a number of exposures without reloading or other manual attention. A 24-volt motor integral with the camera unit supplies the power to simultaneously move the film and rewind the camera shutter when the shutter is tripped by an electrical impulse from the intervalometer.

(*c*) CAMERA MOUNT.—The camera mount permits the camera to swing 50° fore and aft of the vertical position. Two wing nuts on either side of the camera may be loosened to change the camera angle. Two bolts secure the camera in the mount.

(*d*) INTERVALOMETER.—The intervalometer sets up preselected intervals between exposures when the automatic timing feature is being used. The buttons on the face of the instrument provide a means of making a single exposure or starting and stopping the automatic mechanism. The time delay is selected by a dial, graduated in intervals of from 2 to 120 seconds in one-second increments. A jeweled warning light built into the intervalometer flashes two seconds before the camera is tripped, allowing the operator sufficient time to level the camera.

(2) OPERATION OF CAMERA.

(*a*) AUTOMATIC OPERATION.—The camera electrical circuit is designed to operate the camera automatically when the bomb bay doors are fully open. The desired shutter speed can be set on the intervalometer at any time before the bomb bay doors are opened.

(*b*) HAND OPERATION.—The camera can be operated by hand as follows:

1. Turn the handcrank on the right side of the camera until the mechanism disengages.
2. Press the metal button at the forward right side of the camera.

c. COMMUNICATION EQUIPMENT.

(1) DESCRIPTION.

(*a*) LIAISON TRANSMITTER AND RECEIVER.—The SCR-287-A liaison set includes a transmitter with

interchangeable tuning units, a receiver, telegraph key, dynamotor, frequency meter, antenna tuning unit, and the terminal or junction box; all these units are located in the waist gunner's compartment and are controlled by the waist gunner. The liaison set is for communication over comparatively long distance from ship-to-base, or ship-to-ground station, primarily for reporting airplane position or flight progress. The transmitter and the receiver are located on the left forward side of the waist gunner's compartment.

(2) OPERATION.

(*a*) LIAISON TRANSMITTER.—The following are general instructions for operation of the liaison transmitter:

1. Select tuning unit covering the desired frequency on which the transmitter is to operate. Set dials B, C, and D in accordance with calibration chart on tuning unit. Select desired type of emission by turning switch marked "TONE-CW-VOICE." Turn filament switch to position corresponding to type of emission to be used. Turn transmitter master switch "ON."

2. Place antenna change-over switch in desired position. If trailing antenna is to be used, turn control knob on antenna reel box to "OUT."

3. Close either the telegraph key or microphone button, depending upon type of emission selected. Tune dial C to maintain a resonant point indicated by the milliammeter. Turn dial M until full antenna current is shown on antenna current meter. Retune dial C for resonance point.

Note

When operating transmitter, make certain that dial pointers on milliammeter and voltmeter do not exceed the red marks on dial scales.

(*b*) LIAISON RECEIVER.—Turn monitor switch, on lid of liaison set junction box, to "NORMAL." Turn on liaison receiver by means of switch marked "OFF," "MVC" (manual volume control), and "AVC" (automatic volume control). Tuning or searching should be done with the switch turned to the "MVC" position; after the desired signal has been tuned in, the switch should be moved to the "AVC" position. Frequency band selection is accomplished by the "BAND SWITCH" knob on the face of the receiver case under the dial window. Dial calibrations corresponding to the band selected are revealed by the dial mask.

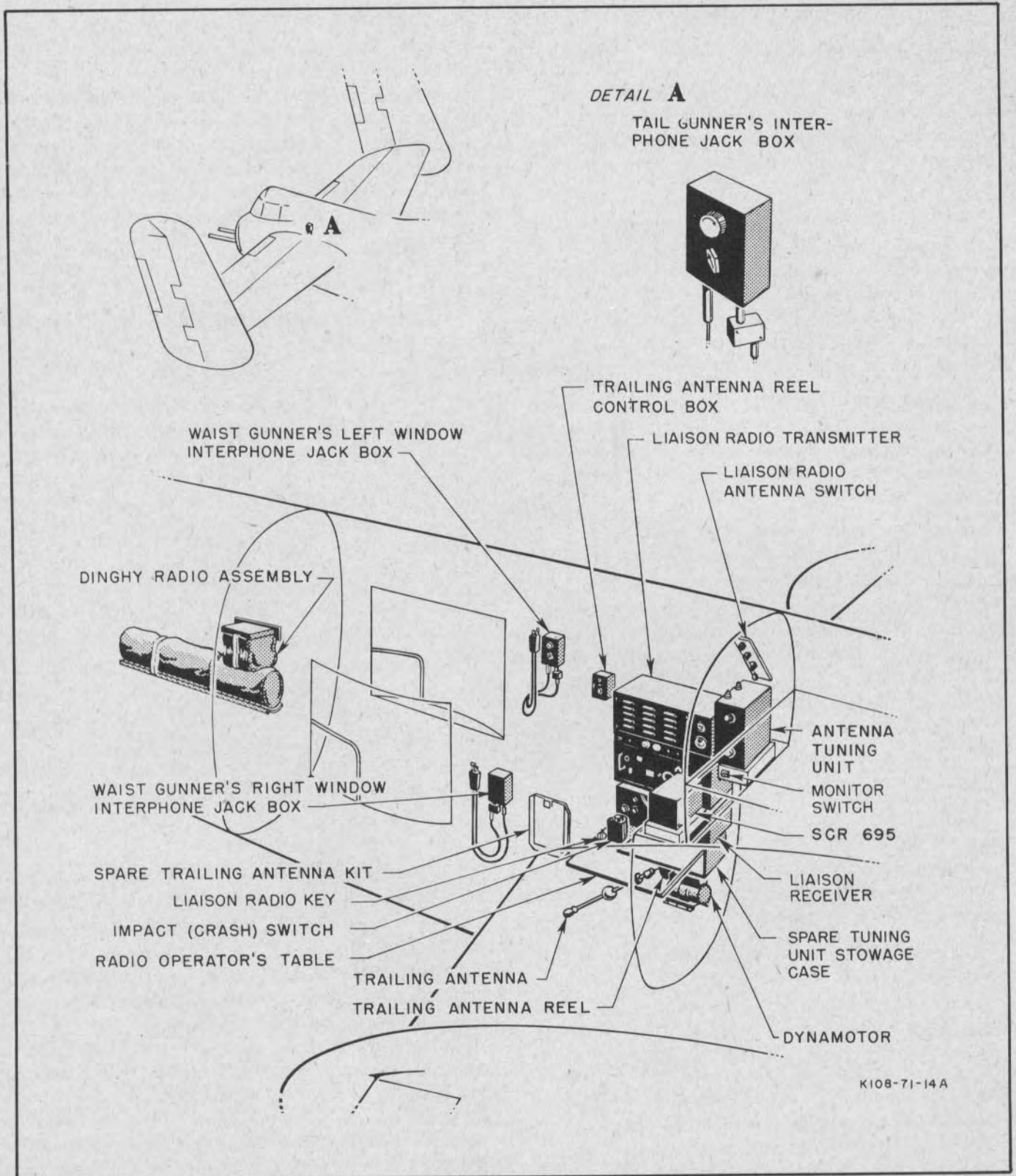

Figure 56—Radio Equipment—Rear Section

WARNING

Do not remove or replace tubes in any of the equipment while equipment is turned on.

(c) TRAILING ANTENNA CONTROL.—To extend the trailing antenna, the control knob is turned right from the "OFF" to the "OUT" position; to retract the antenna, the control knob is turned left from the "OFF" to the "IN" position. A three-digit visible counter indicates the number of turns made by the antenna in extending, and reverses during retraction. The zero point may be reset by means of a small knurled thumb wheel.

NOTE

An amber light above the counter will illuminate if the trailing antenna is left in an extended position as the main landing gear starts to descend. Do not use the trailing antenna for transmitting while on the ground.

The approximate tuning ranges for the trailing antenna are as follows:

KC	LENGTH IN FEET	COUNTER READING	LENGTH IN FEET	COUNTER READING
	¼ WAVE		¾ WAVE	
2,000	123	108		
3,000	82	72		
4,000	62	54		
5,000	49	44	147	130
6,000	41	36	123	108
7,000	35	30	105	92
8,000	31	28	93	82
9,000	27	24	81	72
10,000	24	22	73	64

d. AFT COMPARTMENT HEATER.

(1) STARTING HEATER.

(a) Ask pilot to turn "ON" master cabin heat switch.

(b) Move the switch on the frame in the waist gunner's compartment to "START & HIGH."

(c) If less heat is desired after heater is operating, place switch in "LOW."

NOTE

It is not possible to operate the aft compartment heater on the ground since the heater is dependent upon ram air for operation. When there is insufficient ram air, a pressure cutout switch in the external air scoop automatically shuts off the fuel control solenoid on the heater. An additional safety device is the thermostatically controlled switch in the hot air duct which cuts out the igniter plug at a predetermined temperature.

6. TAIL TURRET GUNNER.

a. TAIL TURRET.

(1) DESCRIPTION.—A Bell Model M-7 electro-hydraulic turret, equipped with two .50-caliber guns and a Type N-8 optical gun sight is mounted in the tail on early airplanes. On late airplanes a Bell Model M-8a turret is installed with a Type K-10 compensating gun sight. Each gun is provided with a 600-round ammunition box and an ammunition booster motor.

(2) OPERATION.

(a) CHARGING GUNS.

1. Lower the guns approximately 10°. Turn off the main power switch.

CAUTION

Always turn off the main power switch when charging the guns or working on the guns or turret.

2. Gain access to the charging handles on the guns by swinging down the sliding armor plate panel at each side of the control handles.

3. Charge each gun by pulling back and releasing its charging handle.

(b) COMBAT OPERATION.

1. Turn on the main power switch, located on the frame to the gunner's right, the gun sight rheostat, on the frame to the gunner's left, and the lamp switch on the gun sight housing. If the gun sight lamp does not come on, press the gun sight lamp circuit-breaker button located at the main power switch.

2. Movement of the guns is controlled by movement of the two interconnected control handles on the control tower. Each handle has a gun trigger switch, an interphone switch, and a safety switch. As each pair of switches is in parallel, the turret can be controlled with either the right or left hand.

3. The direction of gun movement in elevation and azimuth is relative to the direction of movement of the control handles about their vertical axis and horizontal axis. Speed of gun movement is proportional to the degree of movement of the handles from the neutral positions.

4. Maximum movement in elevation is 40° up and 35° down from horizontal. Maximum movement in azimuth is 38° to each side of the centerline of the airplane.

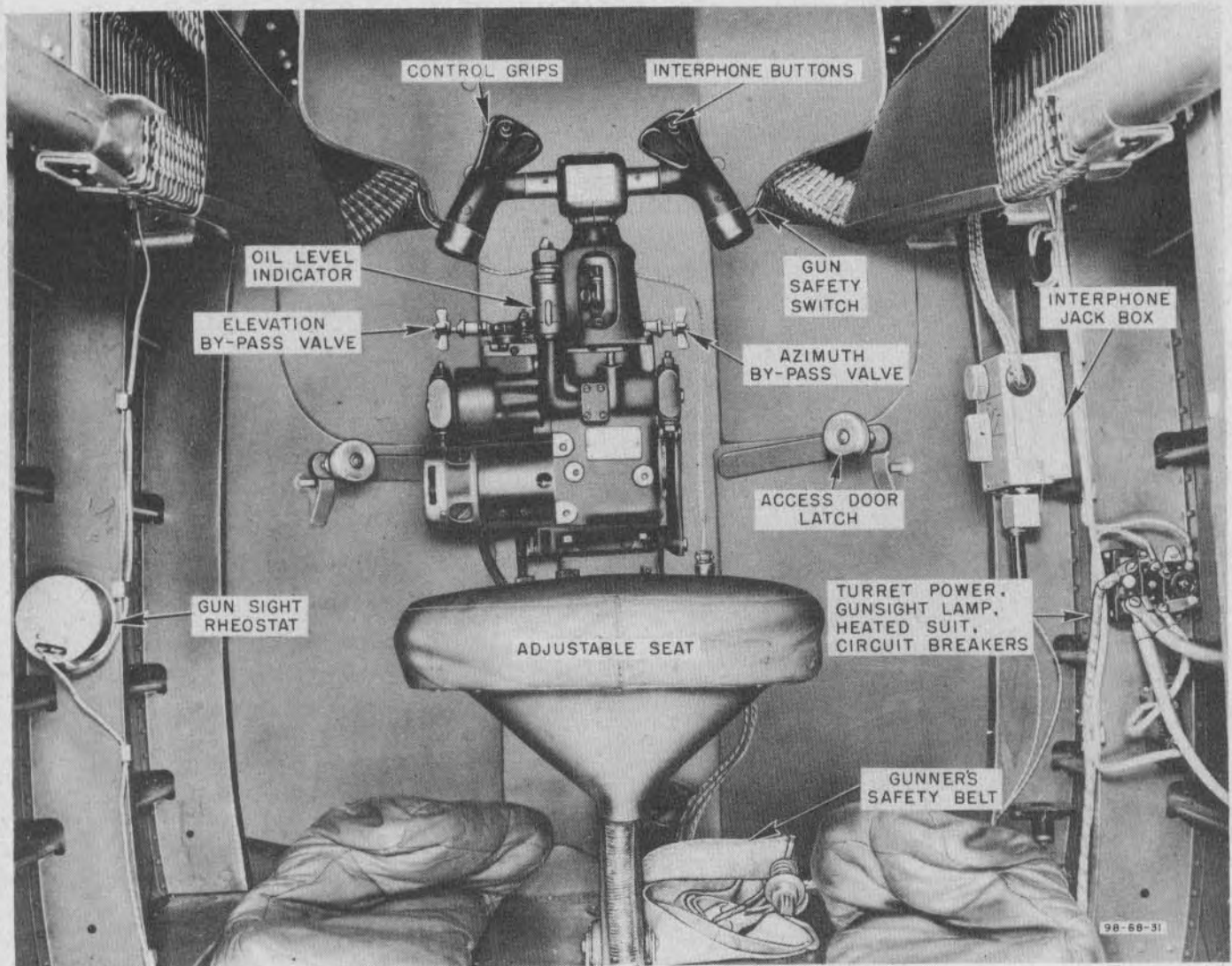

Figure 57—Tail Turret

Note

The guns can be operated manually in an emergency. (See Section IV, paragraph 9. b.)

(3) K-10 COMPENSATING GUN SIGHT.

(See figure 57a.)

(a) GENERAL.—On late airplanes, the tail turret is equipped with a Type K-10 compensating gun sight in place of the Type N-8A optical gun sight.

(b) OPERATION.

1. Turn the rheostat "OFF."
2. Turn "ON" the sight lamp switch. The sight switch has two "ON" positions and the down position should always be used for normal operation.

3. Turn the rheostat until the reticle is just brilliant enough to contrast with the sky. If the reticle image fails to appear in the combining glass, turn the lamp switch to the other "ON" position.

Note

If the reticle fails to appear in either "ON" position a ring and bead sight is provided. These are located on the top cover.

4. Raise the sight filter glass to the up position if light conditions make use of the filter necessary. The filter can be adjusted by means of lever at top of filter bracket.

5. Obtain indicated airspeed and altitude from the pilot.

6. Turn the lubber line knob until the lubber line is matched with the correct altitude setting.

7. Push in the indicated airspeed knob and then turn knob until the airspeed setting is matched with the lubber line.

Note

These two settings must be made with care to make certain that the sight receives the proper data. The accuracy of the sight will be materially affected if the setting is made carelessly, or if an incorrect altitude or I.A.S. is set in.

8. After firing, return the guns to the stowed position. This also stows the sight.

9. Move the sight lamp switch to the "OFF" position by turning the lever to the right.

10. Make certain that the filter glass and the ring and bead sight are in the down position.

b. **TAIL TURRET DEFROSTER.**—A flexible tube leads aft from the heater in the waist gunner's compartment to the tail gunner's station. The control valve and anemostat are located on the right of the tail gunner. From the anemostat, a tube leads to the tail turret sighting panel for

defrosting purposes. Operation of the valve at the anemostat regulates the flow of warm air.

7. OXYGEN SYSTEM.

a. DESCRIPTION.

(1) The airplane is equipped with portable oxygen units. (See figure 58.) In operating position, the oxygen units are supported in canvas sacks attached to the back of the pilot's seat. On late airplanes, one bottle is located behind the pilot's seat and one behind the copilot's seat, and an additional unit is mounted in the bombardier's compartment.

(2) **CYLINDER.**—A Type F-1 low-pressure oxygen cylinder of the externally reinforced type is used. The other parts of the unit are mounted on the cylinder.

(3) **FILLER VALVE.**—A 403-26-A filler valve provides a means of filling the unit, permitting the oxygen to enter the system but preventing the flow from reversing. The valve prevents oxygen from escaping through the filler opening under a pressure range of from 10 to 450 lbs./sq.in.

(4) **REGULATOR.**—A Type AN-R-5 demand regulator automatically controls the flow and dilution of the oxygen. As the user inhales, a diaphragm collapses and

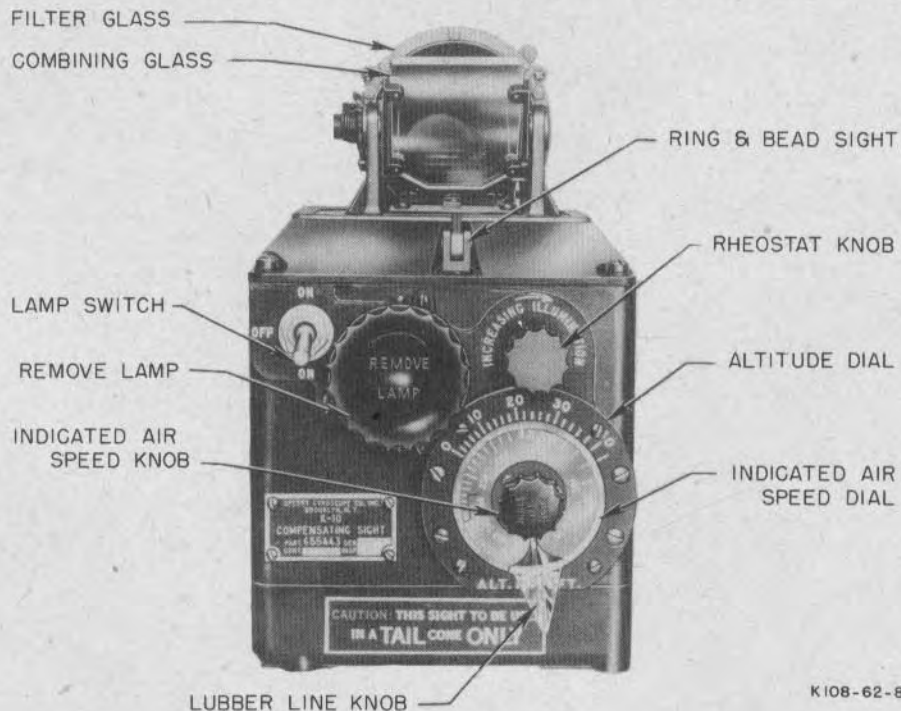

Figure 57A—K-10 Compensating Gun Sight

opens a valve which permits oxygen to flow through the regulator, where it mixes with free air in an amount governed by a bellows-type valve in accordance with the barometric pressure. The oxygen is thus diluted by free air, in inverse proportion to the altitude, in order to conserve the supply. A control enables the user to close the air intake port and render the automatic mixing mechanism inoperative; pure oxygen then flows to the mask as required by the inhalation. An emergency valve on the unit allows the oxygen to by-pass the regulator; the valve is controlled by a red knob. The Type A-12 regulator which may also be used is similar in design to the AN-R-5, and contains all of the above-mentioned features.

(5) PRESSURE GAGE.—A Type K-1 gage indicates the oxygen supply by denoting the pressure within the

cylinder. The dial is calibrated to show pounds per square inch pressure in 50-lb. graduations from 0 to 500.

(6) MASK TUBE.—An AN6003-2 low-pressure tube assembly conducts the oxygen mixture from the regulator to the mask intake tube. The mask end is provided with a jaw-type stowage clamp, and the other end is clamped to the regulator adjustable elbow.

(7) MASK.—The portable unit is designed for use with A-9, A-10, or A-10-A type oxygen masks. A correctly fitted mask of the proper type is extremely important.

b. OPERATING INSTRUCTIONS.—Normal operation of the portable oxygen system is automatic. If the mask is correctly fitted and the system is tight and in proper condition, the user's breathing will set the system in operation and release the right mixture of oxygen for the altitude at

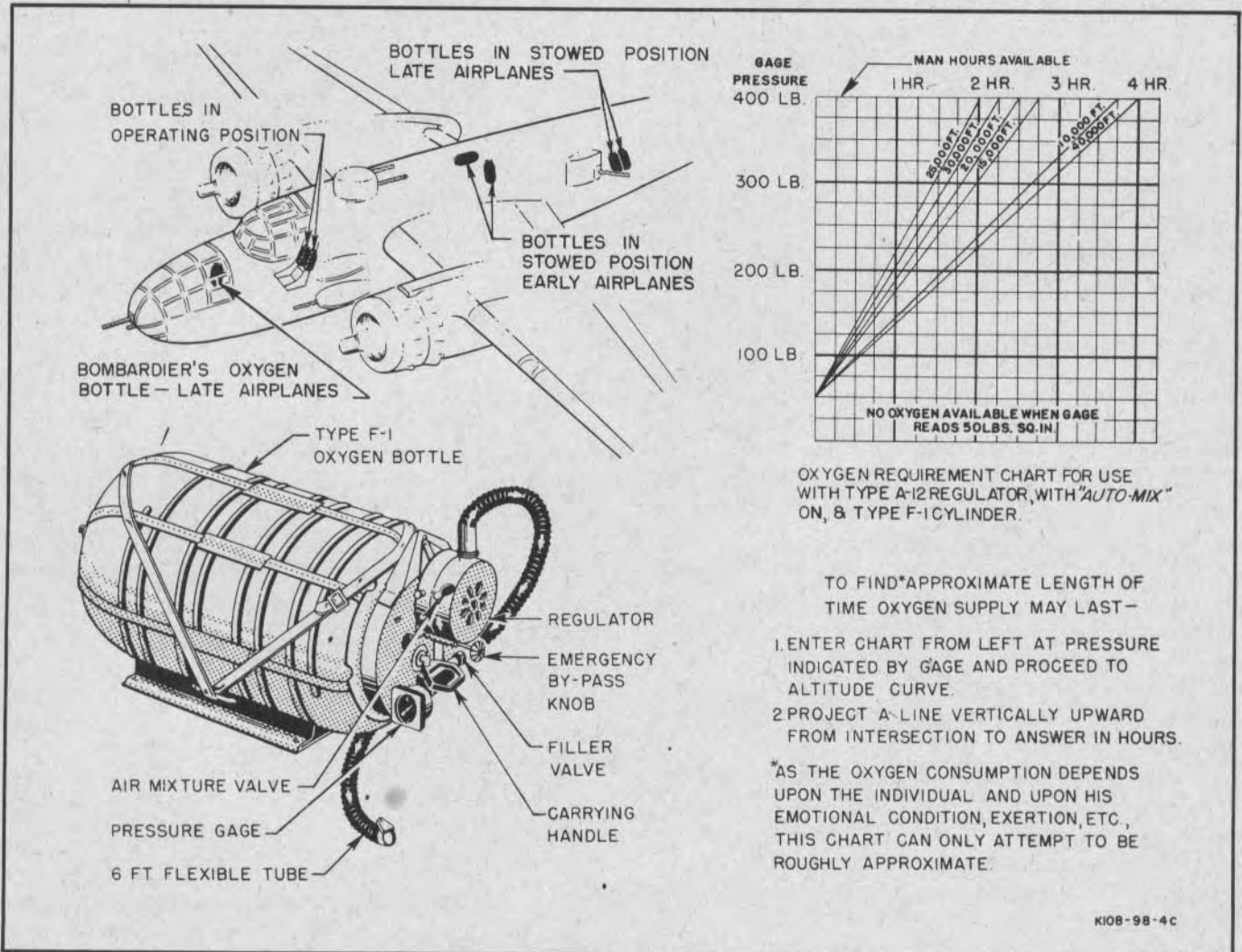

Figure 58—Portable Oxygen Unit

which the unit is being operated. If the mixture valve does not function properly, it may be turned off by turning the thumb lever on the regulator. This will allow pure oxygen to flow to the mask as required by the inhalation of the user. If failure of other parts of the regulator is suspected, the entire regulator mechanism may be by-passed by turning the red emergency knob in a counterclockwise direction. However, for normal operations, the automatic mixture valve must be turned on and the emergency by-pass knob turned off, in order to conserve the oxygen supply. The six-foot flexible tubes allow freedom of movement for the pilot and copilot.

WARNING

Before taking off, flying personnel should make sure that sufficient oxygen is provided for the projected flight and that the masks are of the correct type and fit. It is also important that the entire system be free from oil and grease at all times. If oil or grease comes in contact with any part of the equipment, it should be wiped off immediately. Failure to do this may result in an explosion.

8. MISCELLANEOUS EQUIPMENT.

a. INTERPHONE EQUIPMENT.

(1) DESCRIPTION.—The interphone equipment, RC-36, includes an amplifier, a dynamotor, one jack box for each interphone station, one microphone (throat type) for each crew member, and one low impedance headset for each crew member. A low impedance adapter is installed at each interphone station, the stations being located as follows: The pilot's interphone jack box is mounted on the left side of the pilot's compartment just aft of the instrument panel. The copilot's interphone jack box is mounted on the right side of the pilot's compartment aft of the radio compass control box. The bombardier's interphone jack box is mounted on the right side of the bombardier's compartment just below the window. The upper turret operator's jack box is mounted on the upper right side of the upper turret gunner's compartment opposite the upper turret column. Two gunner's jack boxes are installed in the aft section, forward of each waist gun window. The radio operator's jack box is adjacent to the liaison radio on the left side of the fuselage. The rear turret operator's jack box is mounted on the left side of the airplane opposite the tail gunner's seat.

(2) OPERATION.—The interphone jack box has five selective positions marked on the face of the box:

(a) Position 1 marked "COMP." In this position the audio output of the radio compass only will be heard.

(b) Position 2 marked "LIAISON." In this position the liaison receiver will be heard by all crew members. Only the pilot, copilot, and radio operator can transmit with their jack boxes. On airplanes with SCR-522-A radio equipment, all interphone jack boxes, with the exception of the radio operator's, have had the word "LIAISON" removed, and "VHF" substituted.

(c) Position 3 marked "COMMAND." In this position the command receiver output and sidetone of the command transmitter will be heard, and the microphone push-to-talk switch operates the command transmit-receive relays. The microphone will modulate the command transmitter when the push-to-talk switch is closed and the transmitter control box is in the "VOICE" position.

Note

In the above three positions, a limited control over the volume can be had by turning the increase-output knob.

(d) Position 4 marked "INTER." All jack boxes turned to this position provide an intercommunication system between crew members. The microphone is connected to the input of the interphone amplifier and the headphones to the output of the same amplifier. The volume control is not effective in this position.

(e) Position 5 marked "CALL." This is an emergency call position in which all of the positions of all jack boxes are placed in parallel across the output of the interphone amplifier. Should an emergency arise in which a crew member wishes to call an interphone station in use, he may do so by switching his jack box to "CALL." The microphone is connected to the input of the interphone amplifier. This position is effective at all interphone stations. The handle must be held in the "CALL" position as it is spring-loaded to return to the "INTER" position.

b. SEATS.

(1) BOMBARDIER.—The bombardier's riding seat has a padded cushion attached to the seat and to the back. This seat has been deleted on late airplanes.

(2) PILOT.—The pilot's seat is adjustable, both vertically and horizontally. The back cushion is filled with kapok, and may be used as a life preserver.

(3) COPILOT.—The copilot's seat has a low back and a seat cushion. It can be adjusted both horizontally and vertically. On late airplanes, the copilot's seat is identical to the pilot's seat.

(4) UPPER TURRET GUNNER.—A riding seat is provided on the right side of the upper turret gunner's compartment. The seat folds up flat against the ammunition boxes and clear of the front entrance hatch. A leather strap holds the seat in the stowed position. In combat, the gunner sits on a folding-type bicycle seat attached to the turret column.

(5) RADIO OPERATOR—WAIST GUNNER.—A cushioned folding seat is provided on the right side of the aft compartment for use when operating the radio equipment and is also used as a riding seat. A footrest is also provided at this station.

(6) TAIL GUNNER.—A seat identical to the radio operator's on the left side of the aft compartment is used as a riding seat. The seat has been moved to the right side of the aft compartment on late airplanes. In combat, the tail gunner sits on a bicycle-type seat in the tail turret station.

c. SAFETY BELTS.—All seats, except the upper turret gunner's seat, are provided with safety belts.

d. RELIEF TUBES.—Relief tubes are installed in the pilot's compartment just to the left of the pilot's seat, and on the right side of the aft compartment.

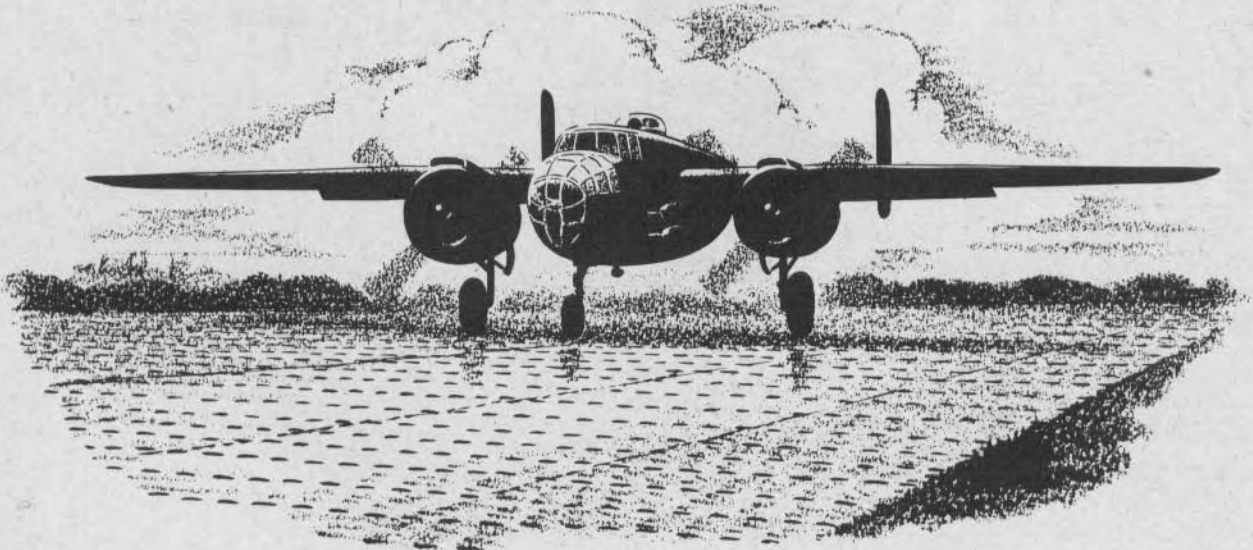

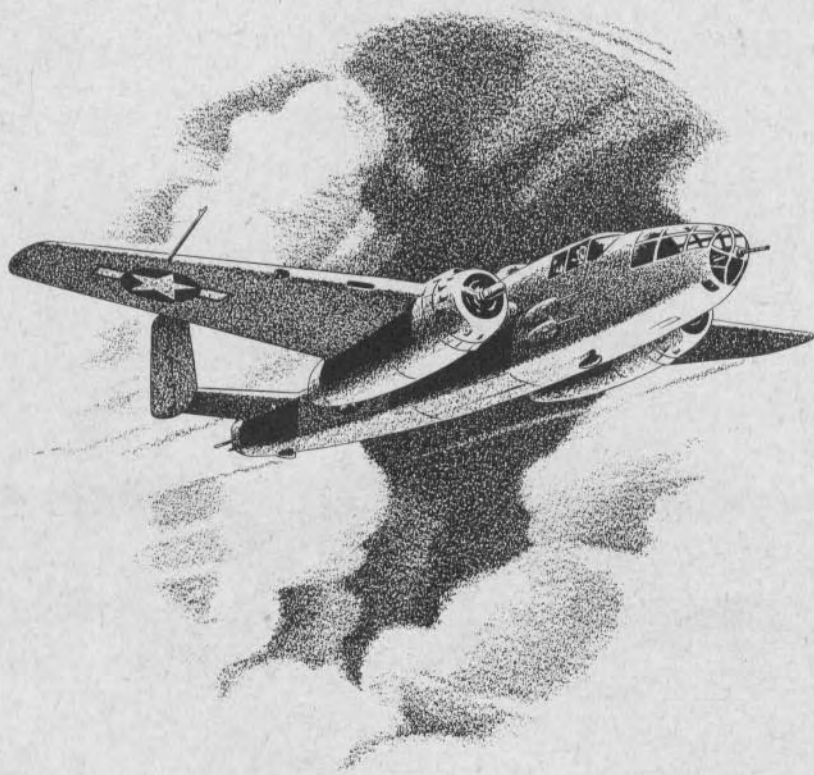



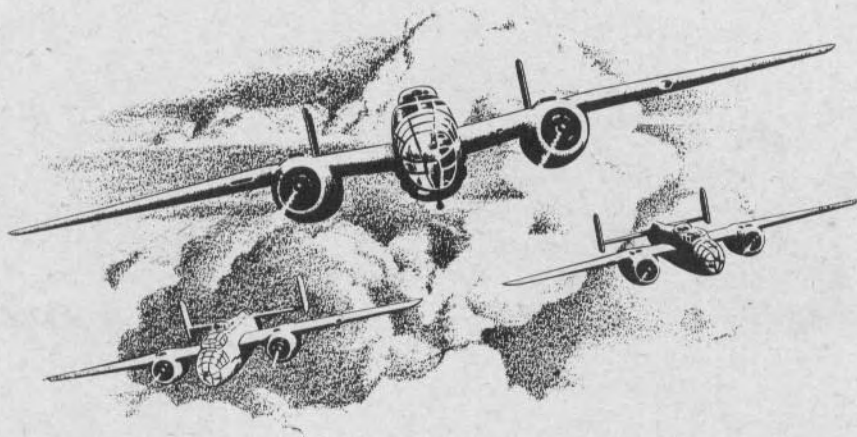

APPENDIX II

FLIGHT OPERATING CHARTS



1. FLIGHT PLANNING.

a. GENERAL.—The following outline may be used as a guide to assist personnel in the use of the Flight Operation Instruction Chart for flight planning purposes.

(1) If the flight plan calls for a continuous flight where the desired cruising power and airspeed are reasonably constant after take-off and climb, the fuel required and flight time may be computed as a "single section flight."

(*a*) Within the limits of the airplane, the fuel required and flying time for a given mission depend largely upon the speed desired. With all other factors remaining equal in an airplane, speed is obtained at a sacrifice of range and range is obtained at a sacrifice of speed. The speed is usually determined after considering the urgency of the flight plotted against the range required. The time of take-off is adjusted so as to have the flight arrive at its destination at the predetermined time.

(*b*) Select the Flight Operation Instruction Chart for the gross weight to be used at take-off. Locate the largest figure entered under gph (gallons per hour) in the column which is applicable to the flight on the lower half of the chart. Multiply this figure by the number or fraction of hours desired for reserve fuel. Add the resulting fuel to the number of gallons obtained from the Take-off and Climb Chart for the take-off gross weight used, and then subtract the total from the amount of fuel in the airplane prior to starting the engines. The figure obtained as a result of this computation will represent the amount of gasoline available and applicable for flight planning purposes on the Range in Air Miles section of the Flight Operation Instruction Chart.

(*c*) Select a figure in the fuel column equal to, or the next entry less than, the available amount of fuel in the airplane, as determined in paragraph 1. *a.* (1) (*b*). Move horizontally to the right or left and select a figure equal to, or the next entry greater than, the air miles (with no wind) to be flown. Operating values contained in the column number in which this figure appears represent the highest cruising speed possible *at the range desired*; however, the

airplane may be operated in accordance with values contained under Operating Data in *any* column of a higher number, with the flight plan being completed at a sacrifice of speed but at an increase of fuel economy.

(*d*) Using the same column number selected by applications of instructions contained in paragraph 1. *a.* (1) (*c*), determine the true airspeed in the lower section of the chart under the subtitle Operating Data. Divide the TAS into the air miles to be flown and obtain the calculated flight duration in hours, which can then be converted into hours and minutes and deducted from the desired arrival time at destination in order to obtain the take-off time (without consideration for wind). To allow for wind, use this TAS as ground speed and calculate a new corrected ground speed, with the aid of a flight calculator or by a navigator's triangle of velocities.

(*e*) The airplane and engine operating values listed below Operating Data in any single numbered column are calculated to give constant miles per gallon at any altitude listed. Therefore, the airplane may be operated at any altitude and at the corresponding set of values given, so long as they are in the same column listing the range desired.

CAUTION

Ranges listed in Column I are shown for the altitude which gives the least miles per gallon. The engine and airplane operating data listed under Operating Data will give constant miles per gallon if operation is consistent with values set opposite the listed altitudes.

(*f*) The flight plan may be readily changed at any time en route, and the chart will show the balance of range at various cruising powers by following the Instructions for Using Chart printed on each page.

(*g*) Multiple charts are provided to give accurate data for operation at different gross weights, different external loads, and/or different combinations of engine use, such as single-engine operation. Extreme caution should be exercised to assure selection of the correct chart applicable to the specific operating condition.

(2) If the original flight plan calls for a mission requiring changes in power, speed, gross load, or external load, in accordance with the titles shown at the top of each chart provided, the total flight should be broken down into a series of individual short flights, each computed as outlined in paragraph 1. *a.* in its entirety, and then added together to make up the total flight and its requirements.

b. SAMPLE PROBLEM. — To carry 3000 pounds of bombs 650 miles to the target and to return, cruising at 10,000 feet. While on the bombing run to use normal rated power for a total of 20 minutes.

(1) By referring to the operating charts for no external load (with 1685-HA carburetor) (*figures 60, 61, and 62*), the fuel required will probably be 1185 gallons which will make a take-off gross weight around 34,000 pounds.

(2) To determine the fuel available for cruising, proceed as follows: First, from the climb chart, the fuel used in take-off and climb will be 105 gallons to reach 10,000 feet. Secondly, from the operating chart for 34,000 pounds, obtain the fuel flow for normal rated power at 10,000 feet (320 gph) from Column I. Thus, 20 minutes at this power will use 110 gallons or a total of 215 gallons for the climb and banking run. However, during the bombing run, some distance will be covered, namely, 90 miles (1/3 hour x 270 mph = 90 miles). Thus, 1210 miles will have to be covered using 970 gallons.

(3) By referring to Column IV on the Operating Chart for 34,000 pounds, 900 gallons will give 1250 miles, which will leave a reserve of 100 gallons at the end of the flight. The exact fuel can be obtained as follows: The distance to be covered from the take-off to the start of the bombing run will be 605 miles. The operating conditions at 10,000 feet

will be 2100 rpm, 29 in. Hg, cruising lean, 165 gph at 235 mph. The time required will be $605 \div 235$, or 2.58 hours, and the fuel used will be 2.58×165 , or 425 gallons.

(4) For the return trip, the operating chart for 30,000 pounds or less should be used inasmuch as the loss of fuel and bombs will bring the weight down to this figure. The operating conditions will be 2050 rpm, 29 in. Hg, cruising lean, 155 gph at 240 mph. The time for the return trip will be $605 \div 240$, or 2.52 hours, with the fuel used 2.52×155 , or 391 gallons. Thus, the total fuel used for the entire trip will be 105 (climb) + 110 (rated power bombing run) + 425 (trip out) + 391 (return trip) or 1031 gallons, leaving a reserve of 154 gallons.

(5) If, by chance, it is necessary to make the return trip at sea level, then the operating conditions will be 2000 rpm, 30 in. Hg, cruising lean, 135 gph at 210 mph. The time required will be $605 \div 210$, or 2.88 hours, and the fuel used will be 2.88×135 , or 390 gallons. Thus, the change in altitude will use the same fuel but will increase the time for the flight by 20 minutes.

(6) In order to have more reserve fuel, the trip may be made at the operating conditions for maximum range (Column V). The operating conditions at 10,000 feet will be 2000 rpm, 28 in. Hg, cruising lean, 140 gph at 215 mph. The time required will be $605 \div 215$, or 2.81 hours, with the fuel used 2.81×140 , or 394 gallons. The return trip (30,000 pounds or less) will require 1850 rpm, 26 in. Hg, cruising lean, 115 gph at 205 mph. The time will be $605 \div 205$, or 2.95 hours, and the fuel used will be 2.95×115 , or 340 gallons. Thus, by using the maximum range operating conditions, the total fuel used will be $105 + 110 + 394 + 340$, or 949 gallons, leaving a reserve of 236 gallons. The difference between problem 1 and 3 will be 82 gallons more reserve and a 40-minute longer trip.

AIRCRAFT MODEL (S)		ENGINE MODEL (S)															
B-25J		R-2600-13 OR -29 1685-HA CARBURETOR															
TAKE-OFF, CLIMB & LANDING CHART																	
TAKE-OFF DISTANCE FEET																	
GROSS WEIGHT LB.	HEAD WIND M.P.H.	HARD SURFACE RUNWAY			500-TURF RUNWAY			SOFT SURFACE RUNWAY									
		AT SEA LEVEL		AT 3000 FEET		AT 6000 FEET		AT 3000 FEET		AT 6000 FEET		AT 6000 FEET					
		GROUND ROLL	TO CLEAR 50' OBJ.	GROUND ROLL	TO CLEAR 50' OBJ.	GROUND ROLL	TO CLEAR 50' OBJ.	GROUND ROLL	TO CLEAR 50' OBJ.	GROUND ROLL	TO CLEAR 50' OBJ.	GROUND ROLL	TO CLEAR 50' OBJ.				
36,000	0	4600	5700	5200	6400	5300	6300	6000	7200	8600	9200	8000	9000	10,500	11,500	13,000	13,000
	17	3400	4200	3600	4600	3700	4500	4200	5200	5400	6400	5400	6400	7700	8300	9300	9300
	34	2400	3100	2500	3300	2500	3300	3000	3800	4000	4000	3500	4000	4700	5000	5000	5000
	51	1400	2000	1500	2100	1400	2200	1900	2600	2600	2600	2500	3000	3600	3700	4000	4000
32,000	0	3300	4200	3700	4700	3700	4600	4000	5000	5300	6600	5300	6300	8000	8200	9100	9100
	17	2400	3100	2700	3500	2700	3400	2900	3700	3500	4600	3500	4500	5900	6100	7100	7100
	34	1600	2300	1800	2600	1900	2500	2000	2700	2700	3300	2700	3200	3700	3700	4400	4400
	51	1000	1600	1200	1800	1300	1800	1400	1900	1900	2200	1700	2100	2500	2500	3000	3000
28,000	0	2300	3000	2500	3300	2500	3300	2700	3500	3500	4200	3500	4200	5200	5200	6000	6000
	17	1700	2300	1800	2500	1800	2500	1900	2700	2700	3100	2500	3100	3700	3700	4300	4300
	34	1200	1700	1300	1800	1300	1800	1400	2000	1600	2300	1600	2200	2800	2800	3300	3300
	51	700	1100	800	1200	900	1300	1000	1500	1200	1700	1000	1500	1900	1900	2400	2400

CLIMB DATA													
GROSS WEIGHT LB.	AT 10,000 FEET			AT 15,000 FEET			AT 20,000 FEET						
	BEST I. A. S.		FROM SEA LEVEL	BEST I. A. S.		FROM SEA LEVEL	BEST I. A. S.		FROM SEA LEVEL				
	MPH	KTS	TIME MIN.	FUEL USED	MPH	KTS	TIME MIN.	FUEL USED	MPH	KTS	TIME MIN.	FUEL USED	
36,000	155	135	700	33	155	135	450	110	150	130	200	32	200
32,000	155	135	950	33	155	135	650	115	150	130	185	21	185
28,000	155	135	1250	33	155	135	950	85	150	130	115	15	115

LANDING DISTANCE FEET												
GROSS WEIGHT LB.	HARD DRY SURFACE			FIRM DRY SOD			WET OR SLIPPERY					
	BEST IAS APPROACH		AT SEA LEVEL	BEST IAS APPROACH		AT SEA LEVEL	BEST IAS APPROACH		AT SEA LEVEL			
	MPH	KTS	GROUND ROLL	TO CLEAR 50' OBJ.	MPH	KTS	GROUND ROLL	TO CLEAR 50' OBJ.	MPH	KTS	GROUND ROLL	TO CLEAR 50' OBJ.
34,000	130	130	1900	2100	4100	2300	4400	4600	4800	8200	10,200	8300
31,000	130	130	1700	1900	3800	2100	2000	4100	4400	7800	9400	8200
25,000	130	130	1400	1500	3300	1700	1500	3500	3800	6500	7900	6800

Figure 59—Take-Off, Climb, and Landing Chart—1685-HA Carburetor

AIRCRAFT MODEL (S) B-25J*		EXTERNAL LOAD ITEMS NONE				FLIGHT OPERATION INSTRUCTION CHART												
ENGINE (S): R-2600-13 OR -29 WITH 1685-HA CARBURETOR		CHART WEIGHT LIMITS: 36,000 TO 33,000 POUNDS				NUMBER OF ENGINES OPERATING: 2												
LIMITS	R.P.M.	M.P.	BLOWER MIXTURE TIME (CYL. POSITION)		TOTAL G.P.H.	INSTRUCTIONS FOR USING CHART: SELECT FIGURE IN FUEL COLUMN EQUAL TO OR LESS THAN AMOUNT OF FUEL TO BE USED FOR CRUISING ⁽¹⁾ MOVE HORIZONTALLY TO RIGHT OR LEFT AND SELECT RANGE VALUE EQUAL TO OR GREATER THAN THE STATUTE OR NAUTICAL AIR MILES TO BE FLOWN. VERTICALLY BELOW AND OPPOSITE VALUE READ REST DESIRED CRUISING ALTITUDE (ALT.) READ RPM, MANIFOLD PRESSURE (M.P.) AND MIXTURE SETTING REQUIRED.												
			WAR	EMERG.		MILITARY POWER	U.S. GAL.	STATUTE	NAUTICAL	COLUMN III RANGE IN AIRMILES	COLUMN IV RANGE IN AIRMILES	COLUMN V RANGE IN AIRMILES	FUEL U.S. GAL.	STATUTE	NAUTICAL	U.S. GAL.	STATUTE	NAUTICAL
WAR	2600	47.5	LOW	F.R.	5 MIN.	554	900	780	1185	1180	1390	1010	1220	1700	1470	1185	1920	1660
MILITARY POWER	2600	41.5	LOW	F.R.	5 MIN.	462	830	720	1100	1100	1290	930	1130	1560	1360	1100	1760	1530
							760	660	1000	1000	1170	850	1020	1410	1220	1000	1590	1380
							680	590	900	900	1050	760	920	1250	1090	900	1410	1220
							800	530	800	800	930	680	810	1110	970	800	1250	1080

MAXIMUM CONTINUOUS		PRESS		ALT.		FEET		M.P.		R.P.M.		M.P.		R.P.M.		M.P.		R.P.M.	
R.P.M.	M.P.	MIX-TURE	APPROX.	TOT.	T.A.S.	GPH.	MPH.	KTS.	INCHES	TURE	INCHES	TURE	INCHES	TURE	INCHES	TURE	INCHES	TURE	INCHES
2400	F.T.	F.R.	315	250	215	20000	25000	21500	34	F.R.	255	260	225	2100	31	F.R.	210	240	210
2400	F.T.	F.R.	400	275	240	15000	15000	15000	34	F.R.	255	260	225	2100	31	F.R.	210	240	210
2400	F.T.	F.R.	320	270	235	10000	10000	10000	34	F.R.	255	260	225	2100	31	F.R.	210	240	210
2400	F.T.	F.R.	355	270	235	5000	5000	5000	34	F.R.	245	250	215	2100	31	F.R.	200	225	200
2400	F.T.	F.R.	330	255	220	S.L.	S.L.	S.L.	34	F.R.	230	230	200	2100	32	F.R.	185	210	185

MAXIMUM AIR RANGE		PRESS		ALT.		FEET		M.P.		R.P.M.		M.P.		R.P.M.		M.P.		R.P.M.	
R.P.M.	M.P.	MIX-TURE	APPROX.	TOT.	T.A.S.	GPH.	MPH.	KTS.	INCHES	TURE	INCHES	TURE	INCHES	TURE	INCHES	TURE	INCHES	TURE	INCHES
40000	40000	40000	40000	40000	40000	40000	40000	40000	28	C.L.	2000	2000	28	C.L.	2000	2000	28	C.L.	2000
35000	35000	35000	35000	35000	35000	35000	35000	35000	29	C.L.	1900	1900	29	C.L.	1900	1900	29	C.L.	1900
30000	30000	30000	30000	30000	30000	30000	30000	30000	30	C.L.	1700	1700	30	C.L.	1700	1700	30	C.L.	1700
25000	25000	25000	25000	25000	25000	25000	25000	25000	31	C.L.	2000	2000	31	C.L.	2000	2000	31	C.L.	2000
20000	20000	20000	20000	20000	20000	20000	20000	20000	31	C.L.	165	235	205	10000	165	235	205	10000	165
15000	15000	15000	15000	15000	15000	15000	15000	15000	31	C.L.	165	225	195	5000	165	225	195	5000	165
									31	C.L.	150	210	180	S.L.	150	210	180	S.L.	150

Figure 60—Flight Operation Instruction Chart—No External Load—36,000 to 33,000 Lbs.—1685-HA Carburetor

LEGEND
 ALT. : PRESSURE ALTITUDE F.P. : FULL RICH
 M.P. : MANIFOLD PRESSURE A.R. : AUTO-RICH
 GPH. : U.S. GAL. PER HOUR A.L. : AUTO-LEAN
 TAS : TRUE AIRSPEED C.L. : CRUISING LEAN
 KTS. : KNOTS M.L. : MANUAL LEAN
 S.L. : SEA LEVEL F.T. : FULL THROTTLE

SPECIAL NOTES
 (1) MAKE ALLOWANCE FOR WARM-UP, TAKE-OFF & CLIMB (SEE FIG. 59)
 PLUS ALLOWANCE FOR WIND, RESERVE AND COMBAT AS REQUIRED.
HIGH BLOWER ABOVE HEAVY LINE
***WITH OR WITHOUT 8-GUN NOSE**

EXAMPLE
 AT 35,000 LB. GROSS WEIGHT WITH 1060 GAL. OF FUEL
 (AFTER DEDUCTING TOTAL ALLOWANCES OF 125 GAL.)
 TO FLY 1000 STAT. AIRMILES AT 10,000 FT. ALTITUDE
 MAINTAIN 2100 RPM AND 29 IN. MANIFOLD PRESSURE
 WITH MIXTURE SET: CRUISING LEAN.

DATA AS OF 10-1-44 BASED ON: FLIGHT TESTS

AFHC-528	AIRCRAFT MODEL(S) B-25J*	EXTERNAL LOAD ITEMS NONE	FLIGHT OPERATION INSTRUCTION CHART	NUMBER OF ENGINES OPERATING: 2
ENGINE(S): R-2500-13 OR -29 WITH 685-HA CARBURETOR		CHART WEIGHT LIMITS: 33,000 TO 30,000 POUNDS		
INSTRUCTIONS FOR USING CHART: SELECT FIGURE IN FUEL COLUMN EQUAL TO OR LESS THAN AMOUNT OF FUEL TO BE USED FOR CRUISING ⁽¹⁾ MOVE HORIZONTALLY TO RIGHT OR LEFT AND SELECT RANGE VALUE EQUAL TO OR GREATER THAN THE STATUTE OR NAUTICAL AIR MILES TO BE FLOWN, VERTICALLY BELOW AND OPPOSITE VALUE NEAREST DESIRED CRUISING ALTITUDE (ALT.) READ RPM, MANIFOLD PRESSURE (M.P.) AND MIXTURE SETTING REQUIRED.				
NOTES: COLUMN I IS FOR EMERGENCY HIGH SPEED CRUISING ONLY, COLUMNS II, III, IV AND V GIVE PROGRESSIVE INCREASE IN RANGE AT A SACRIFICE IN SPEED. AIR MILES PER GALLON (M.P./GAL.) (NO WIND), GALLONS PER HOUR (G.P.H.) AND TRUE AIRSPEED (T.A.S.) ARE APPROXIMATE VALUES FOR REFERENCE. RANGE VALUES ARE FOR AN AVERAGE AIRPLANE FLYING ALONE (NO WIND). TO OBTAIN BRITISH IMPERIAL GAL. (OR G.P.H.): MULTIPLY U.S. GAL. (OR G.P.H.) BY 10 THEN DIVIDE BY 12.				
RANGE IN AIRMILES				
COLUMN I				
FUEL				
U.S. GAL.				
RANGE IN AIRMILES				
STATUTE				
NAUTICAL				
1180	1090	1010	930	850
1020	940	860	780	700
1524	1400	1300	1200	1100
1830	1680	1560	1440	1320
1600	1470	1360	1260	1150
2130	1930	1780	1620	1470
1840	1670	1540	1400	1270
2100	1900	1750	1630	1500
2410	2190	2010	1830	1650
2100	1900	1750	1630	1500
1880	1700	1550	1430	1300
1300	1100	1000	900	800
1524	1400	1300	1200	1100
1830	1680	1560	1440	1320
1600	1470	1360	1260	1150
2130	1930	1780	1620	1470
1840	1670	1540	1400	1270
2100	1900	1750	1630	1500
2410	2190	2010	1830	1650
2100	1900	1750	1630	1500
1880	1700	1550	1430	1300
1300	1100	1000	900	800
1524	1400	1300	1200	1100
1830	1680	1560	1440	1320
1600	1470	1360	1260	1150
2130	1930	1780	1620	1470
1840	1670	1540	1400	1270
2100	1900	1750	1630	1500
2410	2190	2010	1830	1650
2100	1900	1750	1630	1500
1880	1700	1550	1430	1300
1300	1100	1000	900	800
1524	1400	1300	1200	1100
1830	1680	1560	1440	1320
1600	1470	1360	1260	1150
2130	1930	1780	1620	1470
1840	1670	1540	1400	1270
2100	1900	1750	1630	1500
2410	2190	2010	1830	1650
2100	1900	1750	1630	1500
1880	1700	1550	1430	1300
1300	1100	1000	900	800
1524	1400	1300	1200	1100
1830	1680	1560	1440	1320
1600	1470	1360	1260	1150
2130	1930	1780	1620	1470
1840	1670	1540	1400	1270
2100	1900	1750	1630	1500
2410	2190	2010	1830	1650
2100	1900	1750	1630	1500
1880	1700	1550	1430	1300
1300	1100	1000	900	800
1524	1400	1300	1200	1100
1830	1680	1560	1440	1320
1600	1470	1360	1260	1150
2130	1930	1780	1620	1470
1840	1670	1540	1400	1270
2100	1900	1750	1630	1500
2410	2190	2010	1830	1650
2100	1900	1750	1630	1500
1880	1700	1550	1430	1300
1300	1100	1000	900	800
1524	1400	1300	1200	1100
1830	1680	1560	1440	1320
1600	1470	1360	1260	1150
2130	1930	1780	1620	1470
1840	1670	1540	1400	1270
2100	1900	1750	1630	1500
2410	2190	2010	1830	1650
2100	1900	1750	1630	1500
1880	1700	1550	1430	1300
1300	1100	1000	900	800
1524	1400	1300	1200	1100
1830	1680	1560	1440	1320
1600	1470	1360	1260	1150
2130	1930	1780	1620	1470
1840	1670	1540	1400	1270
2100	1900	1750	1630	1500
2410	2190	2010	1830	1650
2100	1900	1750	1630	1500
1880	1700	1550	1430	1300
1300	1100	1000	900	800
1524	1400	1300	1200	1100
1830	1680	1560	1440	1320
1600	1470	1360	1260	1150
2130	1930	1780	1620	1470
1840	1670	1540	1400	1270
2100	1900	1750	1630	1500
2410	2190	2010	1830	1650
2100	1900	1750	1630	1500
1880	1700	1550	1430	1300
1300	1100	1000	900	800
1524	1400	1300	1200	1100
1830	1680	1560	1440	1320
1600	1470	1360	1260	1150
2130	1930	1780	1620	1470
1840	1670	1540	1400	1270
2100	1900	1750	1630	1500
2410	2190	2010	1830	1650
2100	1900	1750	1630	1500
1880	1700	1550	1430	1300
1300	1100	1000	900	800
1524	1400	1300	1200	1100
1830	1680	1560	1440	1320
1600	1470	1360	1260	1150
2130	1930	1780	1620	1470
1840	1670	1540	1400	1270
2100	1900	1750	1630	1500
2410	2190	2010	1830	1650
2100	1900	1750	1630	1500
1880	1700	1550	1430	1300
1300	1100	1000	900	800
1524	1400	1300	1200	1100
1830	1680	1560	1440	1320
1600	1470	1360	1260	1150
2130	1930	1780	1620	1470
1840	1670	1540	1400	1270
2100	1900	1750	1630	1500
2410	2190	2010	1830	1650
2100	1900	1750	1630	1500
1880	1700	1550	1430	1300
1300	1100	1000	900	800
1524	1400	1300	1200	1100
1830	1680	1560	1440	1320
1600	1470	1360	1260	1150
2130	1930	1780	1620	1470
1840	1670	1540	1400	1270
2100	1900	1750	1630	1500
2410	2190	2010	1830	1650
2100	1900	1750	1630	1500
1880	1700	1550	1430	1300
1300	1100	1000	900	800
1524	1400	1300	1200	1100
1830	1680	1560	1440	1320
1600	1470	1360	1260	1150
2130	1930	1780	1620	1470
1840	1670	1540	1400	1270
2100	1900	1750	1630	1500
2410	2190	2010	1830	1650
2100	1900	1750	1630	1500
1880	1700	1550	1430	1300
1300	1100	1000	900	800
1524	1400	1300	1200	1100
1830	1680	1560	1440	1320
1600	1470	1360	1260	1150
2130	1930	1780	1620	1470
1840	1670	1540	1400	1270
2100	1900	1750	1630	1500
2410	2190	2010	1830	1650
2100	1900	1750	1630	1500
1880	1700	1550	1430	1300
1300	1100	1000	900	800
1524	1400	1300	1200	1100
1830	1680	1560	1440	1320
1600	1470	1360	1260	1150
2130	1930	1780	1620	1470
1840	1670	1540	1400	1270
2100	1900	1750	1630	1500
2410	2190	2010	1830	1650
2100	1900	1750	1630	1500
1880	1700	1550	1430	1300
1300	1100	1000	900	800
1524	1400	1300	1200	1100
1830	1680	1560	1440	1320
1600	1470	1360	1260	1150
2130	1930	1780	1620	1470
1840	1670	1540	1400	1270
2100	1900	1750	1630	1500
2410	2190	2010	1830	1650
2100	1900	1750	1630	1500
1880	1700	1550	1430	1300
1300	1100	1000	900	800
1524	1400	1300	1200	1100
1830	1680	1560	1440	1320
1600	1470	1360	1260	1150
2130	1930	1780	1620	1470
1840	1670	1540	1400	1270
2100	1900	1750	1630	1500
2410	2190	2010	1830	1650
2100	1900	1750	1630	1500
1880	1700	1550	1430	1300
1300	1100	1000	900	800
1524	1400	1300	1200	1100
1830	1680	1560	1440	1320
1600	1470	1360	1260	1150
2130	1930	1780	1620	1470
1840	1670	1540	1400	1270
2100	1900	1750	1630	1500
2410	2190	2010	1830	1650
2100	1900	1750	1630	1500
1880	1700	1550	1430	1300
1300	1100	1000	900	800
1524	1400	1300	1200	1100
1830	1680	1560	1440	1320
1600	1470	1360	1260	1150
2130	1930	1780	1620	1470
1840	1670	1540	1400	1270
2100	1900	1750	1630	1500
2410	2190	2010	1830	1650
2100	1900	1750	1630	1500
1880	1700	1550	1430	1300
1300	1100	1000	900	800
1524	1400	1300	1200	1100
1830	1680	1560	1440	1320
1600	1470	1360	1260	1150</

AIRCRAFT MODEL(S) B-25J*		ENGINE(S) : R-2600-13 OR -29 WITH 1685-HA CARBURETOR				EXTERNAL LOAD ITEMS NONE													
LIMITS		CHART WEIGHT LIMITS: 30,000 TO 26,000 POUNDS				NUMBER OF ENGINES OPERATING: 2													
LIMITS	M.P. IN-HG. POSITION	MIXTURE	CYL. POSITION	TOTAL TEMPERATURE	INSTRUCTIONS FOR USING CHART: SELECT FIGURE IN FUEL COLUMN EQUAL TO OR LESS THAN AMOUNT OF FUEL TO BE USED FOR CRUISING. MOVE HORIZONTALLY TO RIGHT OR LEFT AND SELECT RANGE VALUE EQUAL TO OR GREATER THAN THE STATUTE OR NAUTICAL AIR MILES TO BE FLOWN. VERTICALLY BELOW AND OPPOSITE VALUE NEAREST DESIRED CRUISING ALTITUDE (ALT.) READ RPM, MANIFOLD PRESSURE (M.P.) AND MIXTURE SETTING REQUIRED.				COLUMN I		COLUMN II		COLUMN III		COLUMN IV		COLUMN V		
					WAR 2600	EMERG. 2500	MILITARY 2500	POWER 2500	STATUTE	NAUTICAL	U.S. GAL.	RANGE IN AIRMILES	STATUTE	NAUTICAL	U.S. GAL.	STATUTE	NAUTICAL	U.S. GAL.	STATUTE
WAR	47.5	LM	5	594	970	820	1160	1080	960	840	730	1310	1210	800	700	1730	1500	970	1500
EMERG.	41.5	LM	5	562	900	760	1080	940	800	680	590	1020	940	700	600	1610	1390	900	1390
MILITARY	41.5	LM	5	562	800	680	960	840	600	510	420	650	520	400	300	1430	1240	800	1240
POWER	44.0	HIGH	5	516	700	590	840	730	550	480	340	480	360	200	100	1250	1080	700	1080
					300	250	360	240	200	170	80	210	150	100	60	530	460	300	460
					100	80	120	100	100	80	100	100	100	100	100	180	150	100	150

Figure 62—Flight Operation Instruction Chart—No External Load—
30,000 to 26,000 Lbs.—1685-HA Carburetor

LEGEND

- ALT. : PRESSURE ALTITUDE
- F.R. : FULL RICH
- M.P. : MANIFOLD PRESSURE
- A.P. : AUTO-RICH
- GPH : U.S. GAL. PER HOUR
- A.L. : AUTO-LEAN
- TAS : TRUE AIRSPEED
- C.L. : CRUISING LEAN
- KTS. : KNOTS
- M.L. : MANUAL LEAN
- S.L. : SEA LEVEL
- F.T. : FULL THROTTLE

SPECIAL NOTES

- (1) MAKE ALLOWANCE FOR WIND, TAKE-OFF & CLIMB (SEE FIG. 69) PLUS ALLOWANCE FOR WIND, RESERVE AND COMBAT AS REQUIRED.
- HIGH BLOWER ABOVE HEAVY LINE
- *WITH OR WITHOUT 8-GUN NOSE

EXAMPLE

AT 30,000 LB. GROSS WEIGHT WITH 900 GAL. OF FUEL (AFTER DEDUCTING TOTAL ALLOWANCES OF 70 GAL.) TO FLY 1300 STAT. AIRMILES AT 10,000 FT. ALTITUDE MAINTAIN 2050 RPM AND 29 IN. MANIFOLD PRESSURE WITH MIXTURE SET: CRUISING LEAN

AFHC-528 4-1-44		AIRCRAFT MODEL(S) B-26J*				ENGINE(S) : R-2600-13 OR -29 WITH 1685-HA CARBURETOR				FLIGHT OPERATION INSTRUCTION CHART				EXTERNAL LOAD ITEMS I TORPEDO OR 8 WING BOMBS			
LIMITS		M.P. BLOWER MIXTURE TIME		TOTAL		RANGE IN AIRMILES		RANGE IN AIRMILES		RANGE IN AIRMILES		RANGE IN AIRMILES		RANGE IN AIRMILES			
RPM	INCHES	MIN.	SEC.	MIN.	SEC.	STATUTE	NAUTICAL	STATUTE	NAUTICAL	STATUTE	NAUTICAL	STATUTE	NAUTICAL	STATUTE	NAUTICAL		
WAR EMERG.	2000	47.5	LOW	5	598	1185	750	1120	970	1330	1150	1800	1300	1185	1820	1580	
MILITARY POWER	2000	41.5	LOW	5	942	1100	700	1040	900	1230	1070	1490	1290	1100	1680	1460	
	2000	46.0	HIGH	5	516	900	570	890	770	1000	870	1200	1040	900	1360	1040	
	2400	44.0	380	660	570	700	440	660	570	770	670	920	800	700	1030	900	
	2400	44.0	380	570	490	600	380	570	490	660	570	790	680	600	870	760	

MAXIMUM CONTINUOUS		APPROX.		PRESS		APPROX.		PRESS		APPROX.		MAXIMUM AIR RANGE	
M.P. INCHES	MIX-TURE	TOT. GPH	T.A.S. MPH	ALT. FEET	R.P.M.	MIX-TURE	TOT. GPH	T.A.S. MPH	ALT. FEET	R.P.M.	MIX-TURE	TOT. GPH	T.A.S. MPH
40000	35000	30000	25000	20000	2400	F.T. 320	F.R. 355	F.T. 330	F.R. 355	2400	F.T. 320	F.R. 355	F.T. 330
25000	20000	15000	10000	5000	2400	F.T. 355	F.R. 330	2400	F.T. 355	2400	F.T. 355	F.R. 330	2400
15000	10000	5000	3000	2000	2400	F.T. 330	F.R. 320	2400	F.T. 330	2400	F.T. 330	F.R. 320	2400
10000	5000	3000	2000	1500	2400	F.T. 320	F.R. 310	2400	F.T. 320	2400	F.T. 320	F.R. 310	2400

COLUMNS III, IV, V		COLUMNS III, IV, V		COLUMNS III, IV, V		COLUMNS III, IV, V		COLUMNS III, IV, V	
STATUTE	NAUTICAL	STATUTE	NAUTICAL	STATUTE	NAUTICAL	STATUTE	NAUTICAL	STATUTE	NAUTICAL
1820	1580	1820	1580	1820	1580	1820	1580	1820	1580
1680	1460	1680	1460	1680	1460	1680	1460	1680	1460
1360	1200	1360	1200	1360	1200	1360	1200	1360	1200
1030	870	1030	870	1030	870	1030	870	1030	870

Figure 63—Flight Operation Instruction Chart—Torpedo or Wing Bombs—
33,000 to 30,000 Lbs.—1685-HA Carburetor

AIRCRAFT MODEL (S) B-25J*		ENGINE (S): R-2600-13 OR -29 WITH 1685-HA CARBURETOR				FLIGHT OPERATION INSTRUCTION CHART				EXTERNAL LOAD ITEMS I TORPEDO OR B WING BOMBS NUMBER OF ENGINES OPERATING: 2					
LIMITS	RPM	M.P. IN. HG.	BLOWER POSITION	MIXTURE	TIME LIMIT	CYL. TEMP.	TOTAL G.P.H.	INSTRUCTIONS FOR USING CHART: SELECT FIGURE IN FUEL COLUMN EQUAL TO OR LESS THAN AMOUNT OF FUEL TO BE USED FOR CRUISING (1) MOVE HORIZONTALLY TO RIGHT OF LEFT AND SELECT RANGE VALUE EQUAL TO OR GREATER THAN THE STATUTE OR NAUTICAL AIR MILES TO BE FLOWN. VERTICALLY BELOW AND OPPOSITE VALUE NEAREST DESIRED CRUISING ALTITUDE (ALT.) READ RPM, MANIFOLD PRESSURE (M.P.) AND MIXTURE SETTING REQUIRED.				NOTES: COLUMN I IS FOR EMERGENCY HIGH SPEED CRUISING ONLY. COLUMNS II, III, IV AND V GIVE PROGRESSIVE INCREASE IN RANGE AT A SACRIFICE IN SPEED. AIR MILES PER GALLON (M./GAL.) (NO WIND), GALLONS PER HR. (G.P.H.) AND TRUE AIRSPEED (T.A.S.) ARE APPROXIMATE VALUES FOR REFERENCE. RANGE VALUES ARE FOR AN AVERAGE AIRPLANE FLYING ALONE (NO WIND) TO OBTAIN BRITISH IMPERIAL GAL (OR G.P.H.): MULTIPLY U.S. GAL (OR G.P.H.) BY 10 THEN DIVIDE BY 12.			
								WAR	EMERG.	MILITARY	POWER	U.S. GAL.	STATUTE	NAUTICAL	R.P.M.
490	2000	47.5	LOW	F.R.	5	260	554	550	770	670	670	940	810	1080	940
1440 370	2600	81.5	LOW	F.R.	5	260	462	490 410	600 570	600 500	600 500	940 700	730 610	970 810	840 700
290 220	2600	94.0	HIGH	F.R.	5	260	430	330 240	460 340	400 300	400 300	420 360	490 360	650 480	560 420
140 70	2600	94.0	HIGH	F.R.	5	260	430	160 80	230 110	200 100	200 100	280 140	240 120	320 160	280 140

R.P.M.	M.P.	MIX-TURE	APPROX.		PRESS ALT. FEET	MAXIMUM CONTINUOUS	PRESS ALT. FEET	M.P.	MIX-TURE	APPROX.		PRESS ALT. FEET	M.P.	MIX-TURE	APPROX.	
			TOT.	T.A.S.						TOT.	T.A.S.				TOT.	T.A.S.
40000	40000	35000	30000	25000	20000	15000	2400	F.T.	400	265	230	20000	F.T.	400	265	230
2400	F.T.	38	F.R.	320	265	230	2400	F.T.	38	355	265	20000	F.T.	38	355	265
2400	F.T.	38	F.R.	330	250	215	2400	F.T.	38	330	250	15000	F.T.	38	330	250
2400	F.T.	38	F.R.	250	240	210	2400	F.T.	38	250	240	10000	F.T.	38	250	240
2400	F.T.	38	F.R.	235	225	195	2400	F.T.	38	235	225	5000	F.T.	38	235	225
2400	F.T.	38	F.R.	210	200	180	2400	F.T.	38	210	200	1000	F.T.	38	210	200
2400	F.T.	38	F.R.	190	190	180	2400	F.T.	38	190	190	500	F.T.	38	190	190
2400	F.T.	38	F.R.	180	205	180	2400	F.T.	38	180	205	500	F.T.	38	180	205
2400	F.T.	38	F.R.	205	235	205	2400	F.T.	38	205	235	500	F.T.	38	205	235
2400	F.T.	38	F.R.	210	210	210	2400	F.T.	38	210	210	500	F.T.	38	210	210
2400	F.T.	38	F.R.	250	250	250	2400	F.T.	38	250	250	500	F.T.	38	250	250
2400	F.T.	38	F.R.	250	250	250	2400	F.T.	38	250	250	500	F.T.	38	250	250
2400	F.T.	38	F.R.	250	250	250	2400	F.T.	38	250	250	500	F.T.	38	250	250
2400	F.T.	38	F.R.	250	250	250	2400	F.T.	38	250	250	500	F.T.	38	250	250

SPECIAL NOTES

(1) MAKE ALLOWANCE FOR WIND, TAKE-OFF & CLIMB (SEE FIG. 89) PLUS ALLOWANCE FOR WIND, RESERVE AND COMBAT AS REQUIRED.

HIGH BLOWER ABOVE HEAVY LINE

*WITH OR WITHOUT 8-GUN NOSE

DATA AS OF 10-1-44 BASED ON: FLIGHT TESTS

EXAMPLE

AT 30,000 LBS. GROSS WEIGHT WITH 600 GAL. OF FUEL (AFTER DEDUCTING TOTAL ALLOWANCES OF 70 GAL.) TO FLY 800 STAT. AIRMILES AT 5000 FT. ALTITUDE MAINTAIN 2000 RPM AND 30 IN. MANIFOLD PRESSURE WITH MIXTURE SET: CRUISING LEAN

LEGEND

ALT. : PRESSURE ALTITUDE F.R. : FULL RICH
M.P. : MANIFOLD PRESSURE A.R. : AUTO-RICH
GPH : U.S. GAL. PER HOUR A.L. : AUTO-LEAN
TAS : TRUE AIRSPEED C.L. : CRUISING LEAN
KTS. : KNOTS M.L. : MANUAL LEAN
S.L. : SEA LEVEL F.T. : FULL THROTTLE

Figure 64—Flight Operation Instruction Chart—Torpedo or Wing Bombs—
30,000 to 26,000 Lbs.—1685-HA Carburetor

AIRCRAFT MODEL (S) B-25J*			FLIGHT OPERATION INSTRUCTION CHART				EXTERNAL LOAD ITEMS							
ENGINE (S): R-2600-13 OR -29 WITH 1685-HA CARBURETOR			CHART WEIGHT LIMITS: 29,000 TO 27,000 POUNDS				NUMBER OF ENGINES OPERATING: 1							
NOTES: COLUMN I IS FOR EMERGENCY HIGH SPEED CRUISING ONLY. COLUMNS II, III, IV AND V GIVE PROGRESSIVE INCREASE IN RANGE AT A SACRIFICE IN SPEED. AIR MILES PER GALLON (M.P./GAL.) (NO WIND), GALLONS PER HOUR (G.P.H.) AND TRUE AIRSPEED (T.A.S.) ARE APPROXIMATE VALUES FOR REFERENCE. RANGE VALUES ARE FOR AN AVERAGE AIRPLANE FLYING ALONE (NO WIND). TO OBTAIN BRITISH IMPERIAL GAL. (OR G.P.H.): MULTIPLY U.S. GAL. (OR G.P.H.) BY 10 THEN DIVIDE BY 12.			INSTRUCTIONS FOR USING CHART: SELECT FIGURE IN FUEL COLUMN EQUAL TO OR LESS THAN AMOUNT OF FUEL TO BE USED FOR CRUISING. MOVE HORIZONTALLY TO RIGHT OR LEFT AND SELECT RANGE VALUE EQUAL TO OR GREATER THAN THE STATUTE OR NAUTICAL AIR MILES TO BE FLOWN. VERTICALLY BELOW AND OPPOSITE VALUE NEAREST DESIRED CRUISING ALTITUDE (ALT.) READ RPM, MANIFOLD PRESSURE (M.P.) AND MIXTURE SETTING REQUIRED.											
LIMITS			TOTAL											
WAR	M.P. IN. HG.	CYL. LIMIT	M.P. IN. HG.											
EMERG.	97.5	5	590											
MILITARY POWER	91.5	5	402											
	94.8	5	516											
COLUMN I			COLUMN II			COLUMN III			COLUMN IV			COLUMN V		
RANGE IN AIRMILES			RANGE IN AIRMILES			RANGE IN AIRMILES			RANGE IN AIRMILES			RANGE IN AIRMILES		
STATUTE			STATUTE			STATUTE			STATUTE			STATUTE		
NAUTICAL			NAUTICAL			NAUTICAL			NAUTICAL			NAUTICAL		
1020			1180			1030			1000			900		
920			1060			920			900			800		
810			990			820			800			700		
710			820			710			700			600		
MAXIMUM CONTINUOUS			PRESS			PRESS			PRESS			PRESS		
M.P. INCHES			M.P. INCHES			M.P. INCHES			M.P. INCHES			M.P. INCHES		
MIX-TURE			MIX-TURE			MIX-TURE			MIX-TURE			MIX-TURE		
T.A.S.			T.A.S.			T.A.S.			T.A.S.			T.A.S.		
TOT. GPH.			TOT. GPH.			TOT. GPH.			TOT. GPH.			TOT. GPH.		
M.P. INCHES			M.P. INCHES			M.P. INCHES			M.P. INCHES			M.P. INCHES		
MIX-TURE			MIX-TURE			MIX-TURE			MIX-TURE			MIX-TURE		
T.A.S.			T.A.S.			T.A.S.			T.A.S.			T.A.S.		
TOT. GPH.			TOT. GPH.			TOT. GPH.			TOT. GPH.			TOT. GPH.		
M.P. INCHES			M.P. INCHES			M.P. INCHES			M.P. INCHES			M.P. INCHES		
MIX-TURE			MIX-TURE			MIX-TURE			MIX-TURE			MIX-TURE		
T.A.S.			T.A.S.			T.A.S.			T.A.S.			T.A.S.		
TOT. GPH.			TOT. GPH.			TOT. GPH.			TOT. GPH.			TOT. GPH.		
M.P. INCHES			M.P. INCHES			M.P. INCHES			M.P. INCHES			M.P. INCHES		
MIX-TURE			MIX-TURE			MIX-TURE			MIX-TURE			MIX-TURE		
T.A.S.			T.A.S.			T.A.S.			T.A.S.			T.A.S.		
TOT. GPH.			TOT. GPH.			TOT. GPH.			TOT. GPH.			TOT. GPH.		
M.P. INCHES			M.P. INCHES			M.P. INCHES			M.P. INCHES			M.P. INCHES		
MIX-TURE			MIX-TURE			MIX-TURE			MIX-TURE			MIX-TURE		
T.A.S.			T.A.S.			T.A.S.			T.A.S.			T.A.S.		
TOT. GPH.			TOT. GPH.			TOT. GPH.			TOT. GPH.			TOT. GPH.		
M.P. INCHES			M.P. INCHES			M.P. INCHES			M.P. INCHES			M.P. INCHES		
MIX-TURE			MIX-TURE			MIX-TURE			MIX-TURE			MIX-TURE		
T.A.S.			T.A.S.			T.A.S.			T.A.S.			T.A.S.		
TOT. GPH.			TOT. GPH.			TOT. GPH.			TOT. GPH.			TOT. GPH.		
M.P. INCHES			M.P. INCHES			M.P. INCHES			M.P. INCHES			M.P. INCHES		
MIX-TURE			MIX-TURE			MIX-TURE			MIX-TURE			MIX-TURE		
T.A.S.			T.A.S.			T.A.S.			T.A.S.			T.A.S.		
TOT. GPH.			TOT. GPH.			TOT. GPH.			TOT. GPH.			TOT. GPH.		
M.P. INCHES			M.P. INCHES			M.P. INCHES			M.P. INCHES			M.P. INCHES		
MIX-TURE			MIX-TURE			MIX-TURE			MIX-TURE			MIX-TURE		
T.A.S.			T.A.S.			T.A.S.			T.A.S.			T.A.S.		
TOT. GPH.			TOT. GPH.			TOT. GPH.			TOT. GPH.			TOT. GPH.		
M.P. INCHES			M.P. INCHES			M.P. INCHES			M.P. INCHES			M.P. INCHES		
MIX-TURE			MIX-TURE			MIX-TURE			MIX-TURE			MIX-TURE		
T.A.S.			T.A.S.			T.A.S.			T.A.S.			T.A.S.		
TOT. GPH.			TOT. GPH.			TOT. GPH.			TOT. GPH.			TOT. GPH.		
M.P. INCHES			M.P. INCHES			M.P. INCHES			M.P. INCHES			M.P. INCHES		
MIX-TURE			MIX-TURE			MIX-TURE			MIX-TURE			MIX-TURE		
T.A.S.			T.A.S.			T.A.S.			T.A.S.			T.A.S.		
TOT. GPH.			TOT. GPH.			TOT. GPH.			TOT. GPH.			TOT. GPH.		
M.P. INCHES			M.P. INCHES			M.P. INCHES			M.P. INCHES			M.P. INCHES		
MIX-TURE			MIX-TURE			MIX-TURE			MIX-TURE			MIX-TURE		
T.A.S.			T.A.S.			T.A.S.			T.A.S.			T.A.S.		
TOT. GPH.			TOT. GPH.			TOT. GPH.			TOT. GPH.			TOT. GPH.		
M.P. INCHES			M.P. INCHES			M.P. INCHES			M.P. INCHES			M.P. INCHES		
MIX-TURE			MIX-TURE			MIX-TURE			MIX-TURE			MIX-TURE		
T.A.S.			T.A.S.			T.A.S.			T.A.S.			T.A.S.		
TOT. GPH.			TOT. GPH.			TOT. GPH.			TOT. GPH.			TOT. GPH.		
M.P. INCHES			M.P. INCHES			M.P. INCHES			M.P. INCHES			M.P. INCHES		
MIX-TURE			MIX-TURE			MIX-TURE			MIX-TURE			MIX-TURE		
T.A.S.			T.A.S.			T.A.S.			T.A.S.			T.A.S.		
TOT. GPH.			TOT. GPH.			TOT. GPH.			TOT. GPH.			TOT. GPH.		
M.P. INCHES			M.P. INCHES			M.P. INCHES			M.P. INCHES			M.P. INCHES		
MIX-TURE			MIX-TURE			MIX-TURE			MIX-TURE			MIX-TURE		
T.A.S.			T.A.S.			T.A.S.			T.A.S.			T.A.S.		
TOT. GPH.			TOT. GPH.			TOT. GPH.			TOT. GPH.			TOT. GPH.		
M.P. INCHES			M.P. INCHES			M.P. INCHES			M.P. INCHES			M.P. INCHES		
MIX-TURE			MIX-TURE			MIX-TURE			MIX-TURE			MIX-TURE		
T.A.S.			T.A.S.			T.A.S.			T.A.S.			T.A.S.		
TOT. GPH.			TOT. GPH.			TOT. GPH.			TOT. GPH.			TOT. GPH.		
M.P. INCHES			M.P. INCHES			M.P. INCHES			M.P. INCHES			M.P. INCHES		
MIX-TURE			MIX-TURE			MIX-TURE			MIX-TURE			MIX-TURE		
T.A.S.			T.A.S.			T.A.S.			T.A.S.			T.A.S.		
TOT. GPH.			TOT. GPH.			TOT. GPH.			TOT. GPH.			TOT. GPH.		
M.P. INCHES			M.P. INCHES			M.P. INCHES			M.P. INCHES			M.P. INCHES		
MIX-TURE			MIX-TURE			MIX-TURE			MIX-TURE			MIX-TURE		
T.A.S.			T.A.S.			T.A.S.			T.A.S.			T.A.S.		
TOT. GPH.			TOT. GPH.			TOT. GPH.			TOT. GPH.			TOT. GPH.		
M.P. INCHES			M.P. INCHES			M.P. INCHES			M.P. INCHES			M.P. INCHES		
MIX-TURE			MIX-TURE			MIX-TURE			MIX-TURE			MIX-TURE		
T.A.S.			T.A.S.			T.A.S.			T.A.S.			T.A.S.		
TOT. GPH.			TOT. GPH.			TOT. GPH.			TOT. GPH.			TOT. GPH.		
M.P. INCHES			M.P. INCHES			M.P. INCHES			M.P. INCHES			M.P. INCHES		
MIX-TURE			MIX-TURE			MIX-TURE			MIX-TURE			MIX-TURE		
T.A.S.			T.A.S.			T.A.S.			T.A.S.			T.A.S.		
TOT. GPH.			TOT. GPH.			TOT. GPH.			TOT. GPH.			TOT. GPH.		
M.P. INCHES			M.P. INCHES			M.P. INCHES			M.P. INCHES			M.P. INCHES		
MIX-TURE			MIX-TURE			MIX-TURE			MIX-TURE			MIX-TURE		
T.A.S.			T.A.S.			T.A.S.			T.A.S.			T.A.S.		
TOT. GPH.			TOT. GPH.			TOT. GPH.			TOT. GPH.			TOT. GPH.		
M.P. INCHES			M.P. INCHES			M.P. INCHES			M.P. INCHES			M.P. INCHES		
MIX-TURE			MIX-TURE			MIX-TURE			MIX-TURE			MIX-TURE		
T.A.S.			T.A.S.			T.A.S.			T.A.S.			T.A.S.		
TOT. GPH.			TOT. GPH.			TOT. GPH.			TOT. GPH.			TOT. GPH.		
M.P. INCHES			M.P. INCHES			M.P. INCHES			M.P. INCHES			M.P. INCHES		
MIX-TURE			MIX-TURE			MIX-TURE			MIX-TURE			MIX-TURE		
T.A.S.			T.A.S.			T.A.S.			T.A.S.			T.A.S.		
TOT. GPH.			TOT. GPH.			TOT. GPH.			TOT. GPH.			TOT. GPH.		
M.P. INCHES			M.P. INCHES			M.P. INCHES			M.P. INCHES			M.P. INCHES		
MIX-TURE			MIX-TURE			MIX-TURE			MIX-TURE			MIX-TURE		
T.A.S.			T.A.S.			T.A.S.			T.A.S.			T.A.S.		
TOT. GPH.			TOT. GPH.			TOT. GPH.			TOT. GPH.			TOT. GPH.		
M.P. INCHES			M.P. INCHES			M.P. INCHES			M.P. INCHES			M.P. INCHES		
MIX-TURE			MIX-TURE			MIX-TURE			MIX-TURE			MIX-TURE		
T.A.S.			T.A.S.			T.A.S.			T.A.S.			T.A.S.		
TOT. GPH.			TOT. GPH.			TOT. GPH.			TOT. GPH.			TOT. GPH.		
M.P. INCHES			M.P. INCHES			M.P. INCHES			M.P. INCHES			M.P. INCHES		
MIX-TURE			MIX-TURE			MIX-TURE			MIX-TURE			MIX-TURE		
T.A.S.			T.A.S.			T.A.S.			T.A.S.			T.A.S.		
TOT. GPH.			TOT. GPH.			TOT. GPH.			TOT. GPH.			TOT. GPH.		
M.P. INCHES			M.P. INCHES			M.P. INCHES			M.P. INCHES			M.P. INCHES		
MIX-TURE			MIX-TURE			MIX-TURE			MIX-TURE			MIX-TURE		
T.A.S.			T.A.S.			T.A.S.			T.A.S.			T.A.S.		
TOT. GPH.			TOT. GPH.			TOT. GPH.			TOT. GPH.			TOT. GPH.		
M.P. INCHES			M.P. INCHES			M.P. INCHES			M.P. INCHES			M.P. INCHES		
MIX-TURE			MIX-TURE			MIX-TURE			MIX-TURE			MIX-TURE		
T.A.S.			T.A.S.			T.A.S.			T.A.S.			T.A.S.		
TOT. GPH.			TOT. GPH.			TOT. GPH.			TOT. GPH.			TOT. GPH.		
M.P. INCHES			M.P. INCHES			M.P. INCHES			M.P. INCHES			M.P. INCHES		
MIX-TURE			MIX-TURE			MIX-TURE			MIX-TURE			MIX-TURE		
T.A.S.			T.A.S.			T.A.S.			T.A.S.			T.A.S.		
TOT. GPH.			TOT. GPH.			TOT. GPH.			TOT. GPH.			TOT. GPH.		
M.P. INCHES			M.P. INCHES			M.P. INCHES			M.P. INCHES			M.P. INCHES		
MIX-TURE			MIX-TURE			MIX-TURE			MIX-TURE			MIX-TURE		
T.A.S.			T.A.S.			T.A.S.			T.A.S.			T.A.S.		
TOT. GPH.			TOT. GPH.			TOT. GPH.			TOT. GPH.			TOT. GPH.		
M.P. INCHES			M.P. INCHES			M.P. INCHES			M.P. INCHES			M.P. INCHES		
MIX-TURE			MIX-TURE			MIX-TURE			MIX-TURE			MIX-TURE		
T.A.S.			T.A.S.			T.A.S.			T.A.S.			T.A.S.		
TOT. GPH.			TOT. GPH.			TOT. GPH.			TOT. GPH.			TOT. GPH.		
M.P. INCHES			M.P. INCHES			M.P. INCHES			M.P. INCHES			M.P. INCHES		
MIX-TURE			MIX-TURE			MIX-TURE			MIX-TURE			MIX-TURE		
T.A.S.			T.A.S.			T.A.S.			T.A.S.			T.A.S.		
TOT. GPH.			TOT. GPH.			TOT. GPH.			TOT. GPH.			TOT. GPH.		
M.P. INCHES			M.P. INCHES			M.P. INCHES			M.P. INCHES			M.P. INCHES		
MIX-TURE			MIX-TURE			MIX-TURE			MIX-TURE			MIX-TURE		
T.A.S.			T.A.S.			T.A.S.			T.A.S.			T.A.S.		
TOT. GPH.			TOT. GPH.			TOT. GPH.			TOT. GPH.			TOT. GPH.		
M.P. INCHES			M.P. INCHES			M.P. INCHES			M.P. INCHES			M.P. INCHES		
MIX-TURE			MIX-TURE			MIX-TURE			MIX-TURE			MIX-TURE		
T.A.S.			T.A.S.			T.A.S.			T.A.S.			T.A.S.		
TOT. GPH.			TOT. GPH.			TOT. GPH.			TOT. GPH.			TOT. GPH.		
M.P. INCHES			M.P. INCHES			M.P. INCHES			M.P. INCHES			M.P. INCHES		
MIX-TURE			MIX-TURE			MIX-TURE			MIX-TURE			MIX-TURE		
T.A.S.			T.A.S.			T.A.S.			T.A.S.			T.A.S.		
TOT. GPH.			TOT. GPH.			TOT. GPH.			TOT. GPH.			TOT. GPH.		
M.P. INCHES			M.P. INCHES			M.P. INCHES			M.P. INCHES			M.P. INCHES		
MIX-TURE			MIX-TURE			MIX-TURE			MIX-TURE			MIX-TURE		
T.A.S.			T.A.S.			T.A.S.			T.A.S.			T.A.S.		
TOT. GPH.			TOT. GPH.			TOT. GPH.			TOT. GPH.			TOT. GPH.		
M.P. INCHES			M.P. INCHES			M.P. INCHES			M.P. INCHES			M.P. INCHES		
MIX-TURE			MIX-TURE			MIX-TURE			MIX-TURE			MIX-TURE		
T.A.S.			T.A.S.			T.A.S.			T.A.S.			T.A.S.		
TOT. GPH.			TOT. GPH.			TOT. GPH.			TOT. GPH.			TOT. GPH.		
M.P. INCHES			M.P. INCHES			M.P. INCHES			M.P. INCHES			M.P. INCHES		
MIX-TURE			MIX-TURE			MIX-TURE			MIX-TURE			MIX-TURE		
T.A.S.			T.A.S.			T.A.S.			T.A.S.			T.A.S.		
TOT. GPH.			TOT. GPH.			TOT. GPH.			TOT. GPH.			TOT. GPH.		
M.P. INCHES			M.P. INCHES			M.P. INCHES			M.P. INCHES			M.P. INCHES		
MIX-TURE			MIX-TURE											

AIRCRAFT MODEL (S) B-25J*		FLIGHT OPERATION INSTRUCTION CHART				EXTERNAL LOAD ITEMS					
ENGINE (S): R-2600-13 OR -29 WITH 1685-HA CARBURETOR		CHART WEIGHT LIMITS: 27,000 TO 24,000 POUNDS				NUMBER OF ENGINES OPERATING: 1					
LIMITS		INSTRUCTIONS FOR USING CHART: SELECT FIGURE IN FUEL COLUMN EQUAL TO OR LESS THAN AMOUNT OF FUEL TO BE USED FOR CRUISING. MOVE HORIZONTALLY TO RIGHT OR LEFT AND SELECT RANGE VALUE EQUAL TO OR GREATER THAN THE STATUTE OR NAUTICAL AIR MILES TO BE FLOWN. VERTICALLY BELOW AND OPPOSITE VALUE NEAREST DESIRED CRUISING ALTITUDE (ALT.) READ RPM, MANIFOLD PRESSURE (M.P.) AND MIXTURE SETTING REQUIRED.				NOTES: COLUMN I IS FOR EMERGENCY HIGH SPEED CRUISING ONLY. COLUMNS II, III, IV AND V GIVE PROGRESSIVE INCREASE IN RANGE AT A SACRIFICE IN SPEED. AIR MILES PER GALLON (M.P./GAL.) (NO WIND), GALLONS PER HOUR (G.P.H.) AND TRUE AIRSPEED (T.A.S.) ARE APPROXIMATE VALUES FOR REFERENCE. RANGE VALUES ARE FOR AN AVERAGE AIRPLANE FLYING ALONE (NO WIND). TO OBTAIN BRITISH IMPERIAL GAL. (OR G.P.H.) MULTIPLY U.S. GAL. (OR G.P.H.) BY 10 THEN DIVIDE BY 12.					
MILITARY POWER		COLUMN I		COLUMN II		COLUMN III		COLUMN IV		COLUMN V	
RPM	M.P. IN. HG.	MIXTURE POSITION	TIME LIMIT	CYL. TEMP.	TOTAL G.P.H.	RANGE IN AIRMILES		RANGE IN AIRMILES		RANGE IN AIRMILES	
WAR	2600	LOW	5 MIN.	250	500	STATUTE	NAUTICAL	STATUTE	NAUTICAL	STATUTE	NAUTICAL
EMERG.	2600	HIGH	5 MIN.	290	516	SUBTRACT FUEL ALLOWANCES NOT AVAILABLE FOR CRUISING (1)					
MILITARY POWER		COLUMN I		COLUMN II		COLUMN III		COLUMN IV		COLUMN V	
RPM	M.P. IN. HG.	MIXTURE POSITION	TIME LIMIT	CYL. TEMP.	TOTAL G.P.H.	STATUTE	NAUTICAL	STATUTE	NAUTICAL	STATUTE	NAUTICAL
WAR	2600	LOW	5 MIN.	250	500	740	640	880	730	940	810
EMERG.	2600	HIGH	5 MIN.	290	516	630	550	720	620	800	690
MILITARY POWER		COLUMN I		COLUMN II		COLUMN III		COLUMN IV		COLUMN V	
RPM	M.P. IN. HG.	MIXTURE POSITION	TIME LIMIT	CYL. TEMP.	TOTAL G.P.H.	STATUTE	NAUTICAL	STATUTE	NAUTICAL	STATUTE	NAUTICAL
WAR	2600	LOW	5 MIN.	250	500	530	460	600	520	670	580
EMERG.	2600	HIGH	5 MIN.	290	516	420	370	480	410	530	460
MILITARY POWER		COLUMN I		COLUMN II		COLUMN III		COLUMN IV		COLUMN V	
RPM	M.P. IN. HG.	MIXTURE POSITION	TIME LIMIT	CYL. TEMP.	TOTAL G.P.H.	STATUTE	NAUTICAL	STATUTE	NAUTICAL	STATUTE	NAUTICAL
WAR	2600	LOW	5 MIN.	250	500	320	270	360	310	400	350
EMERG.	2600	HIGH	5 MIN.	290	516	210	180	240	210	270	230
MILITARY POWER		COLUMN I		COLUMN II		COLUMN III		COLUMN IV		COLUMN V	
RPM	M.P. IN. HG.	MIXTURE POSITION	TIME LIMIT	CYL. TEMP.	TOTAL G.P.H.	STATUTE	NAUTICAL	STATUTE	NAUTICAL	STATUTE	NAUTICAL
WAR	2600	LOW	5 MIN.	250	500	100	90	120	100	130	110
EMERG.	2600	HIGH	5 MIN.	290	516						

Figure 66—Flight Operation Instruction Chart—Single Engine—27,000 to 24,000 Lbs.—1685-HA Carburetor

SPECIAL NOTES
(1) MAKE ALLOWANCE FOR WARM-UP, TAKE-OFF & CLIMB (SEE FIG.) PLUS ALLOWANCE FOR WIND, RESERVE AND COMBAT AS REQUIRED.
ALL LOW BLOWER
***WITH OR WITHOUT 8-GUN NOSE**
DATA AS OF 10-1-44 BASED ON: FLIGHT TESTS

EXAMPLE
AT 27,000 LB. GROSS WEIGHT WITH 600 GAL. OF FUEL (AFTER DEDUCTING TOTAL ALLOWANCES OF 0 GAL.) TO FLY 800 STAT. AIRMILES AT 3-L. FT. ALTITUDE MAINTAIN 2100 RPM AND 32 IN. MANIFOLD PRESSURE WITH MIXTURE SET: FULL RICH

LEGEND
ALT. : PRESSURE ALTITUDE F.R. : FULL RICH
M.P. : MANIFOLD PRESSURE A.R. : AUTO-RICH
GPH : U.S. GAL. PER HOUR A.L.L. : AUTO-LEAN
TAS : TRUE AIRSPEED C.L. : CRUISING LEAN
KTS. : KNOTS M.L. : MANUAL LEAN
S.L. : SEA LEVEL F.T. : FULL THROTTLE

AIRCRAFT MODEL(S)		ENGINE MODEL(S)														
B-25J		R-2600-29														
*WITH OR WITHOUT 8-GUN NOSE		1685-HB CARBURETOR														
TAKE-OFF, CLIMB & LANDING CHART		TAKE-OFF DISTANCE FEET														
GROSS WEIGHT LB.	HEAD WIND M.P.H.	HARD SURFACE RUNWAY				SOFT SURFACE RUNWAY										
		AT SEA LEVEL		AT 3000 FEET		AT SEA LEVEL		AT 3000 FEET		AT 6000 FEET						
		GROUND ROLL	TO CLEAR 50' OBJ.	GROUND ROLL	TO CLEAR 50' OBJ.	GROUND ROLL	TO CLEAR 50' OBJ.	GROUND ROLL	TO CLEAR 50' OBJ.	GROUND ROLL	TO CLEAR 50' OBJ.					
36,000	0	4500	5700	5200	6800	6700	8100	5300	6300	7200	7500	9200	9350	10,500	11,500	13,000
	17	3400	4200	3600	4600	4600	5900	3700	4500	5200	5500	6900	6650	7700	8200	9500
	34	2900	3100	2500	3200	3300	4300	2500	3300	3800	4000	5200	4900	5700	6300	7000
	51	1400	2000	1500	2100	1900	2700	1600	2200	2600	2600	3800	3200	3800	4300	4800
32,000	0	3300	4200	3700	4700	4700	5900	3700	4600	5000	5300	6600	6300	7300	7800	8500
	17	2400	3100	2700	3500	3400	4400	2700	3400	3700	3800	4600	4200	5000	5400	6100
	34	1600	2300	1800	2300	2300	3200	1900	2500	2700	2500	3300	2700	3100	3400	4000
	51	1000	1600	1200	1800	1400	2100	1300	1800	1900	1600	2200	1700	2100	2300	2800
28,000	0	2300	3000	2500	3300	3000	4000	2500	3300	3500	3200	4200	3700	4500	4800	5400
	17	1700	2300	1800	2500	2200	3100	1800	2500	2700	2300	3100	2500	3100	3300	3900
	34	1200	1700	1300	1900	1500	2300	1300	1800	2000	1600	2300	1650	2000	2100	2600
	51	700	1100	800	1200	900	1500	900	1300	1500	1200	1700	1000	1300	1500	1800

NOTE: INCREASE CHART DISTANCES AS FOLLOWS: 75% + 10%; 100% + 20%; 125% + 30%; 150% + 40%
DATA AS OF 4-20-44 BASED ON: FLIGHT TESTS

CLIMB DATA

GROSS WEIGHT LB.	AT SEA LEVEL		AT 5000 FEET		AT 10,000 FEET		AT 15,000 FEET		AT 20,000 FEET		AT 3000 FEET		AT 6000 FEET		AT 1000 FEET	
	BEST I.A.S. MPH	RATE OF CLIMB F.P.M.	BEST I.A.S. MPH	RATE OF CLIMB F.P.M.	BEST I.A.S. MPH	RATE OF CLIMB F.P.M.	BEST I.A.S. MPH	RATE OF CLIMB F.P.M.	BEST I.A.S. MPH	RATE OF CLIMB F.P.M.	FROM SEA LEVEL	FROM SEA LEVEL	FROM SEA LEVEL	FROM SEA LEVEL	FROM SEA LEVEL	FROM SEA LEVEL
	KTS	FUEL USED GAL.	KTS	FUEL USED GAL.	KTS	FUEL USED GAL.	KTS	FUEL USED GAL.	KTS	FUEL USED GAL.	BEST I.A.S. MPH	RATE OF CLIMB F.P.M.	BEST I.A.S. MPH	RATE OF CLIMB F.P.M.	BEST I.A.S. MPH	RATE OF CLIMB F.P.M.
36,000	155	850	155	135	135	550	12.5	105	150	130	400	21.0	165	145	125	100
32,000	155	1100	155	135	135	800	10.0	90	150	130	650	16.5	135	145	125	250
28,000	155	1400	155	135	135	1050	7.5	80	150	130	900	12.5	110	145	125	450

POWER PLANT SETTINGS: (DETAILS ON FIG. SECTION 111)
DATA AS OF 10-1-44 BASED ON: FLIGHT TESTS

FUEL USED (U.S. GAL.) INCLUDES WARM-UP & TAKE-OFF ALLOWANCE

LANDING DISTANCE FEET

GROSS WEIGHT LB.	BEST IAS APPROACH		HARD DRY SURFACE		FIRM DRY SOD		WET OR SLIPPERY	
	POWER OFF	POWER ON	AT SEA LEVEL	AT 3000 FEET	AT SEA LEVEL	AT 3000 FEET	AT SEA LEVEL	AT 3000 FEET
	MPH	KTS	GROUND ROLL	TO CLEAR 50' OBJ.	GROUND ROLL	TO CLEAR 50' OBJ.	GROUND ROLL	TO CLEAR 50' OBJ.
36,000	130	130	1900	2100	2200	2400	2600	2800
32,000	130	130	1700	1900	2000	2200	2400	2600
28,000	130	130	1400	1500	1600	1800	1900	2100

DATA AS OF 4-20-44 BASED ON: FLIGHT TESTS

REMARKS:

NOTE: TO DETERMINE FUEL CONSUMPTION IN BRITISH IMPERIAL GALLONS, MULTIPLY BY 10, THEN DIVIDE BY 12.

LEGEND

I.A.S. : INDICATED AIRSPEED
M.P.H. : MILES PER HOUR
KTS. : KNOTS
F.P.M. : FEET PER MINUTE
OPTIMUM LANDING IS 80% OF CHART VALUES

Figure 67—Take-Off, Climb, and Landing Chart—1685-HB Carburetor

AIRCRAFT MODEL(S) B-25J*		ENGINE(S) : R-2800-29 WITH 1685-HB CARBURETOR				FLIGHT OPERATION INSTRUCTION CHART												EXTERNAL LOAD ITEMS NONE	NUMBER OF ENGINES OPERATING: 2												
LIMITS		M.P. BLOWER MIXTURE TIME		CYL. POSITION LIMIT		TOTAL		INSTRUCTIONS FOR USING CHART: SELECT FIGURE IN FUEL COLUMN EQUAL TO OR LESS THAN AMOUNT OF FUEL TO BE USED FOR CRUISING. MOVE HORIZONTALLY TO RIGHT OR LEFT AND SELECT RANGE VALUE EQUAL TO OR GREATER THAN THE STATUTE OR NAUTICAL AIR MILES TO BE FLOWN. VERTICALLY BELOW AND OPPOSITE VALUE NEAREST DESIRED CRUISING ALTITUDE (ALT.) READ RPM, MANIFOLD PRESSURE (M.P.) AND MIXTURE SETTING, REQUIRED.												NOTES: COLUMN I IS FOR EMERGENCY HIGH SPEED CRUISING ONLY. COLUMNS II, III, IV AND V GIVE PROGRESSIVE INCREASE IN RANGE AT A SACRIFICE IN SPEED. AIR MILES PER GALLON (MI./GAL.) (NO WIND), GALLONS PER HOUR (G.P.H.) AND TRUE AIRSPEED (T.A.S.) ARE APPROXIMATE VALUES FOR REFERENCE. RANGE VALUES ARE FOR AN AVERAGE AIRPLANE FLYING ALONE (NO WIND) TO OBTAIN BRITISH IMPERIAL GAL. (OR G.P.H.) MULTIPLY U.S. GAL. (OR G.P.H.) BY 10 THEN DIVIDE BY 12.											
WAR		2500		5		580		COLUMN I												FUEL											
EMERG.		2500		5		580		COLUMN II												FUEL											
MILITARY POWER		2500		5		580		COLUMN III												FUEL											
R.P.M.		M.P.		T.A.S.		ALT.		COLUMN IV												FUEL											
INCHES		INCHES		MPH		FEET		COLUMN V												FUEL											
MIX-TURE		MIX-TURE		MIX-TURE		MIX-TURE		COLUMN VI												FUEL											
T.A.S.		T.A.S.		T.A.S.		T.A.S.		COLUMN VII												FUEL											
MPH		MPH		MPH		MPH		COLUMN VIII												FUEL											
T.A.S.		T.A.S.		T.A.S.		T.A.S.		COLUMN IX												FUEL											
MPH		MPH		MPH		MPH		COLUMN X												FUEL											
T.A.S.		T.A.S.		T.A.S.		T.A.S.		COLUMN XI												FUEL											
MPH		MPH		MPH		MPH		COLUMN XII												FUEL											
T.A.S.		T.A.S.		T.A.S.		T.A.S.		COLUMN XIII												FUEL											
MPH		MPH		MPH		MPH		COLUMN XIV												FUEL											
T.A.S.		T.A.S.		T.A.S.		T.A.S.		COLUMN XV												FUEL											
MPH		MPH		MPH		MPH		COLUMN XVI												FUEL											
T.A.S.		T.A.S.		T.A.S.		T.A.S.		COLUMN XVII												FUEL											
MPH		MPH		MPH		MPH		COLUMN XVIII												FUEL											
T.A.S.		T.A.S.		T.A.S.		T.A.S.		COLUMN XIX												FUEL											
MPH		MPH		MPH		MPH		COLUMN XX												FUEL											
T.A.S.		T.A.S.		T.A.S.		T.A.S.		COLUMN XXI												FUEL											
MPH		MPH		MPH		MPH		COLUMN XXII												FUEL											
T.A.S.		T.A.S.		T.A.S.		T.A.S.		COLUMN XXIII												FUEL											
MPH		MPH		MPH		MPH		COLUMN XXIV												FUEL											
T.A.S.		T.A.S.		T.A.S.		T.A.S.		COLUMN XXV												FUEL											
MPH		MPH		MPH		MPH		COLUMN XXVI												FUEL											
T.A.S.		T.A.S.		T.A.S.		T.A.S.		COLUMN XXVII												FUEL											
MPH		MPH		MPH		MPH		COLUMN XXVIII												FUEL											
T.A.S.		T.A.S.		T.A.S.		T.A.S.		COLUMN XXIX												FUEL											
MPH		MPH		MPH		MPH		COLUMN XXX												FUEL											
2400	F.T.	295	265	230	20000	2250	37	F.R.	270	260	225	2150	30	F.R.	205	235	205	2100	29	C.L.	150	210	185	10000	2050	28	C.L.	135	200	175	40000
2400	F.T.	375	280	240	15000	2250	37	F.R.	250	240	210	2150	31	F.R.	200	225	195	2100	31	C.L.	160	220	190	5000	1900	30	C.L.	140	205	180	35000
2400	F.T.	310	265	230	10000	2250	34	F.R.	270	260	225	2150	30	F.R.	205	235	205	2100	29	C.L.	150	210	185	10000	2050	28	C.L.	135	200	175	30000
2400	F.T.	375	280	240	15000	2250	34	F.R.	250	240	210	2150	31	F.R.	200	225	195	2100	31	C.L.	160	220	190	5000	1900	30	C.L.	140	205	180	30000
2400	F.T.	345	245	215	5000	2250	34	F.R.	235	225	195	2150	31	F.R.	180	210	180	2100	31	C.L.	145	205	180	S.L.	1850	30	C.L.	125	185	160	25000
2400	F.T.	375	280	240	15000	2250	37	F.R.	270	260	225	2150	30	F.R.	205	235	205	2100	29	C.L.	150	210	185	10000	2050	28	C.L.	135	200	175	20000
2400	F.T.	375	280	240	15000	2250	37	F.R.	250	240	210	2150	31	F.R.	200	225	195	2100	31	C.L.	160	220	190	5000	1900	30	C.L.	140	205	180	15000
2400	F.T.	345	245	215	5000	2250	34	F.R.	235	225	195	2150	31	F.R.	180	210	180	2100	31	C.L.	145	205	180	S.L.	1850	30	C.L.	125	185	160	25000

LEGEND
ALT. : PRESSURE ALTITUDE
M.P. : MANIFOLD PRESSURE
GPM : U.S. GAL. PER HOUR
TAS : TRUE AIRSPEED
KTS. : KNOTS
S.L. : SEA LEVEL
F.R. : FULL RICH
A.R. : AUTO-RICH
A.L. : AUTO-LEAN
C.L. : CRUISING LEAN
M.L. : MANUAL LEAN
F.T. : FULL THROTTLE

EXAMPLE
AT 35,000 LB. GROSS WEIGHT WITH 1080 GAL. OF FUEL (AFTER DEDUCTING TOTAL ALLOWANCES OF 125 GAL.) TO FLY 1400 STAT. AIRMILES AT 10,000 FT. ALTITUDE MAINTAIN 2100 RPM AND 29 IN. MANIFOLD PRESSURE WITH MIXTURE SET: CRUISING LEAN

SPECIAL NOTES
(1) MAKE ALLOWANCE FOR WARM-UP, TAKE-OFF & CLIMB (SEE FIG. 67) + PLUS ALLOWANCE FOR WIND, RESERVE AND COMBAT AS REQUIRED.
HIGH BLOWER ABOVE HEAVY LINE
*WITH OR WITHOUT 8-GUN NOSE

DATA AS OF 10-1-44 BASED ON: FLIGHT TESTS

Figure 67A—Flight Operation Instruction Chart—No External Load—36,000 to 33,000 Lbs.—1685-HB Carburetor

LIMITS	AIRCRAFT MODEL(S) B-25J*				FLIGHT OPERATION INSTRUCTION CHART				EXTERNAL LOAD ITEMS NONE					
	RPM	M.P. IN. HG.	MIXTURE POSITION	TIME LIMIT	CYL. TEMP.	G.P.H.	TOTAL	CHART WEIGHT LIMITS: 33,000 TO 30,000 POUNDS				NUMBER OF ENGINES OPERATING: 2		
WAR EMERG.	2600	47.5	LOW	5 MIN.	260	548								
MILITARY POWER	2600	41.5	LOW	5 MIN.	240	482								
	2600	44.0	HIGH	5 MIN.	240	480								

COLUMN I		COLUMN II		COLUMN III		COLUMN IV		COLUMN V	
RANGE IN AIRMILES		RANGE IN AIRMILES		RANGE IN AIRMILES		RANGE IN AIRMILES		RANGE IN AIRMILES	
STATUTE	NAUTICAL	STATUTE	NAUTICAL	STATUTE	NAUTICAL	STATUTE	NAUTICAL	STATUTE	NAUTICAL
1100	950	1450	1250	1790	1550	2280	1970	2530	2200
1010	870	1330	1150	1640	1420	2090	1810	2320	2020
940	810	1230	1060	1520	1320	1930	1670	2140	1860
860	750	1140	980	1400	1210	1780	1540	1970	1710
790	690	1040	900	1280	1110	1620	1400	1800	1560
720	620	950	820	1160	1010	1470	1270	1620	1410
650	560	850	740	1040	900	1310	1130	1490	1260

FUEL		FUEL		FUEL		FUEL	
U.S. GAL.	NAUTICAL GAL.	U.S. GAL.	NAUTICAL GAL.	U.S. GAL.	NAUTICAL GAL.	U.S. GAL.	NAUTICAL GAL.
1524	950	1450	1250	1790	1550	2280	1970
1400	870	1330	1150	1640	1420	2090	1810
1300	810	1230	1060	1520	1320	1930	1670
1200	750	1140	980	1400	1210	1780	1540
1100	690	1040	900	1280	1110	1620	1400
1000	620	950	820	1160	1010	1470	1270
900	560	850	740	1040	900	1310	1130

MAXIMUM CONTINUOUS PRESS		MAXIMUM AIR RANGE	
M.P. INCHES	MIX-TURE	R.P.M.	MIX-TURE
TOT. GPH.	T.A.S. MPH.	TOT. GPH.	T.A.S. MPH.
2400	F.R. 295	2400	F.R. 295
2400	F.R. 275	2400	F.R. 275
2400	F.R. 255	2400	F.R. 255
2400	F.R. 235	2400	F.R. 235
2400	F.R. 215	2400	F.R. 215
2400	F.R. 195	2400	F.R. 195

SPECIAL NOTES	
(1) MAKE ALLOWANCE FOR WARM-UP, TAKE-OFF & CLIMB (SEE FIG. 67) PLUS ALLOWANCE FOR WIND, RESERVE AND COMBAT AS REQUIRED.	
HIGH BLOWER ABOVE HEAVY LINE	
*WITH OR WITHOUT 8-GUN NOSE.	

LEGEND	
ALT. : PRESSURE ALTITUDE	F.R. : FULL RICH
M.P. : MANIFOLD PRESSURE	A.R. : AUTO-RICH
GPH : U.S. GAL. PER HOUR	A.L. : AUTO-LEAN
TAS : TRUE AIRSPEED	C.L. : CRUISING LEAN
KTS. : KNOTS	M.L. : MANUAL LEAN
S.L. : SEA LEVEL	F.T. : FULL THROTTLE

EXAMPLE	
AT 33,000 LB. GROSS WEIGHT WITH 1400 GAL. OF FUEL (AFTER DEDUCTING TOTAL ALLOWANCES OF 98 GAL.) TO FLY 2000 STAT. AIRMILES AT 10,000 FT. ALTITUDE MAINTAIN 2100 RPM AND 29 IN. MANIFOLD PRESSURE WITH MIXTURE SET: CRUISING LEAN	

DATA AS OF 10-1-44	
BASED ON: FLIGHT TESTS	

Figure 67B—Flight Operation Instruction Chart—No External Load—33,000 to 30,000 Lbs.—1685-HB Carburetor

AIRCRAFT MODEL (S) B-25J*		EXTERNAL LOAD ITEMS 1 TORPEDO OR 8 WING BOMBS NUMBER OF ENGINES OPERATING: 2										
ENGINE (S): R-2600-29 WITH 1685-HB CARBURETOR		CHART WEIGHT LIMITS: 33,000 TO 30,000 POUNDS										
LIMITS	R.P.M.	M.P. IN. HG.	MIXTURE POSITION	TIME CYL. LIMIT	TOTAL G.P.H.	INSTRUCTIONS FOR USING CHART: SELECT FIGURE IN FUEL COLUMN EQUAL TO OR LESS THAN AMOUNT OF FUEL TO BE USED FOR CRUISING. MOVE HORIZONTALLY TO RIGHT OR LEFT AND SELECT RANGE VALUE EQUAL TO OR GREATER THAN THE STATUTE OR NAUTICAL AIR MILES TO BE FLOWN. VERTICALLY BELOW AND OPPOSITE VALUE NEAREST DESIRED CRUISING ALTITUDE (ALT., READ RPM, MANIFOLD PRESSURE (M.P.) AND MIXTURE SETTING REQUIRED.						
						WAR EMERG.	MILITARY POWER	LOW	HIGH	LOW	HIGH	
WAR EMERG.	2900	47.5	LOW	5 MIN.	580	LOW	580	HIGH	580			
MILITARY POWER	2600	41.5	LOW	5 MIN.	482	LOW	482	HIGH	482			
<p>NOTES: COLUMN I IS FOR EMERGENCY-HIGH SPEED CRUISING ONLY. COLUMNS II, III, IV AND V GIVE PROGRESSIVE INCREASE IN RANGE AT A SACRIFICE IN SPEED. AIR MILES PER GALLON (MI./GAL.) (NO WIND), GALLONS PER HR. (G.P.H.) AND TRUE AIRSPEED (T.A.S.) ARE APPROXIMATE VALUES FOR REFERENCE. RANGE VALUES ARE FOR AN AVERAGE AIRPLANE FLYING ALONE (NO WIND). TO OBTAIN BRITISH IMPERIAL GAL. (OR G.P.H.) MULTIPLY (U.S. GAL. (OR G.P.H.)) BY 10 THEN DIVIDE BY 12.</p>												
RANGE IN AIRMILES		COLUMN I		COLUMN II		COLUMN III		COLUMN IV		COLUMN V		
STATUTE	NAUTICAL	STATUTE	NAUTICAL	STATUTE	NAUTICAL	STATUTE	NAUTICAL	STATUTE	NAUTICAL	STATUTE	NAUTICAL	
830	710	1185	1060	1270	1110	1620	1400	1185	1550	1800	1550	
770	660	1100	980	1180	1020	1500	1300	1100	1440	1680	1440	
700	600	1000	890	1070	930	1360	1180	1000	1300	1500	1300	
630	540	900	790	960	830	1220	1050	900	1160	1340	1160	
580	480	800	700	850	740	1080	930	800	1030	1190	1030	
490	420	700	600	740	640	940	810	700	890	1030	890	
420	360	600	510	630	540	800	690	600	750	870	750	
<p>MAXIMUM CONTINUOUS PRESS (1.85 STAT. (-7% NAUT.) MI./GAL.) (1.05 STAT. (-9% NAUT.) MI./GAL.) (1.35 STAT. (-1.5% NAUT.) MI./GAL.)</p>												
R.P.M.	M.P. INCHES	MIX-TURE	T.A.S.	T.A.S.	T.A.S.	M.P. INCHES	MIX-TURE	T.A.S.	T.A.S.	M.P. INCHES	MIX-TURE	T.A.S.
2900	41	F.R. 295	255	225	230	2250	38	2300	38	2250	38	2300
2400	41	F.R. 375	265	230	230	2200	38	2200	38	2100	31	2100
2400	41	F.R. 310	255	225	230	2150	30	2150	30	2100	29	2100
2400	38	F.R. 370	255	225	230	205	31	205	31	200	31	200
2400	38	F.R. 345	235	205	205	190	32	190	32	175	31	175
<p>MAXIMUM AIR RANGE PRESS ALT. FEET</p>												
40000	35000	30000	25000	20000	15000	40000	35000	30000	25000	20000	15000	
2900	41	F.R. 295	255	225	230	2250	38	2300	38	2250	38	2300
2400	41	F.R. 375	265	230	230	2200	38	2200	38	2100	31	2100
2400	41	F.R. 310	255	225	230	2150	30	2150	30	2100	29	2100
2400	38	F.R. 370	255	225	230	205	31	205	31	200	31	200
2400	38	F.R. 345	235	205	205	190	32	190	32	175	31	175

LEGEND
 ALT. : PRESSURE ALTITUDE F.R. : FULL RICH
 M.P. : MANIFOLD PRESSURE A.R. : AUTO-RICH
 G.P.H. : U.S. GAL. PER HOUR A.L. : AUTO-LEAN
 T.A.S. : TRUE AIRSPEED C.L. : CRUISING LEAN
 KTS. : KNOTS M.L. : MANUAL LEAN
 S.L. : SEA LEVEL F.T. : FULL THROTTLE

EXAMPLE
 AT 30,000 LB. GROSS WEIGHT WITH 1000 GAL. OF FUEL (AFTER REDUCING TOTAL ALLOWANCES OF 85 GAL.) TO FLY 1500 STAT. AIRMILES AT 10,000 FT. ALTITUDE MAINTAIN 2100 RPM AND 29 IN. MANIFOLD PRESSURE WITH MIXTURE SET: CRUISING LEAN

SPECIAL NOTES
 (1) MAKE ALLOWANCE FOR WARM-UP, TAKE-OFF AND CLIMB (SEE FIG. 67) PLUS ALLOWANCE FOR WIND, RESERVE AND COMBAT *REQUIRED.
HIGH BLOWER ABOVE HEAVY LINE
***WITH OR WITHOUT 8 GUN NOSE**

DATA AS OF 10-1-44 BASED ON: FLIGHT TESTS

Figure 67D—Flight Operation Instruction Chart—Torpedo or Wing Bombs—33,000 to 30,000 Lbs.—1685-HB Carburetor

AFHC-528 I-1-BB		AIRCRAFT MODEL (S) B-25J*		ENGINE (S) : R-2600-29 WITH 1685-HB CARBURETOR		EXTERNAL LOAD ITEMS 1 TORPEDO OR 8 WING BOMBS		NUMBER OF ENGINES OPERATING: 2			
LIMITS	RPM	M.P. INCHES	BLOWER POSITION	MIXTURE	TIME LIMIT	CTL. TEMP.	TOTAL G.P.H.	INSTRUCTIONS FOR USING CHART: SELECT FIGURE IN FUEL COLUMN EQUAL TO OR LESS THAN AMOUNT OF FUEL TO BE USED FOR CRUISING, ⁽¹⁾ MOVE HORIZONTALLY TO RIGHT OR LEFT AND SELECT RANGE VALUE EQUAL TO OR GREATER THAN THE STATUTE OR NAUTICAL AIR MILES TO BE FLOWN, VERTICALLY BELOW AND OPPOSITE VALUE NEAREST DESIRED CRUISING ALTITUDE (ALT.) READ RPM, MANIFOLD PRESSURE (M.P.) AND MIXTURE SETTING REQUIRED.			
								WAR EMERG.	MILITARY POWER	LOW F.R.	HIGH F.R.
		COLUMN I		COLUMN II		COLUMN III		COLUMN IV		COLUMN V	
RANGE IN AIRMILES		RANGE IN AIRMILES		RANGE IN AIRMILES		RANGE IN AIRMILES		RANGE IN AIRMILES		RANGE IN AIRMILES	
STATUTE		STATUTE		STATUTE		STATUTE		STATUTE		STATUTE	
NAUTICAL		NAUTICAL		NAUTICAL		NAUTICAL		NAUTICAL		NAUTICAL	
470		410		630		730		940		1060	
420		360		570		570		730		950	
350		300		470		480		610		790	
260		240		380		380		490		630	
210		180		280		290		360		470	
140		120		190		190		240		310	
70		60		90		90		120		160	
FUEL		FUEL		FUEL		FUEL		FUEL		FUEL	
U.S.		U.S.		U.S.		U.S.		U.S.		U.S.	
GAL.		GAL.		GAL.		GAL.		GAL.		GAL.	
670		670		670		640		820		820	
600		600		600		570		730		820	
500		500		500		480		610		790	
400		400		400		380		490		630	
300		300		300		290		360		470	
200		200		200		190		240		310	
100		100		100		80		120		160	
MAXIMUM CONTINUOUS		MAXIMUM CONTINUOUS		MAXIMUM CONTINUOUS		MAXIMUM CONTINUOUS		MAXIMUM CONTINUOUS		MAXIMUM CONTINUOUS	
M.P.		M.P.		M.P.		M.P.		M.P.		M.P.	
INCHES		INCHES		INCHES		INCHES		INCHES		INCHES	
2400		2400		2400		2250		2200		1950	
295		295		295		260		225		1950	
375		375		375		270		225		29	
MIX-TURE		MIX-TURE		MIX-TURE		MIX-TURE		MIX-TURE		MIX-TURE	
T.A.S.		T.A.S.		T.A.S.		T.A.S.		T.A.S.		T.A.S.	
TOT.		TOT.		TOT.		TOT.		TOT.		TOT.	
GPH.		GPH.		GPH.		GPH.		GPH.		GPH.	
MPH.		MPH.		MPH.		MPH.		MPH.		MPH.	
KTS.		KTS.		KTS.		KTS.		KTS.		KTS.	
40000		40000		40000		35000		30000		25000	
35000		35000		35000		30000		25000		20000	
25000		25000		25000		20000		15000		10000	
20000		20000		20000		15000		10000		5000	
15000		15000		15000		10000		5000		S.L.	
PRESS		PRESS		PRESS		PRESS		PRESS		PRESS	
ALT.		ALT.		ALT.		ALT.		ALT.		ALT.	
FEET		FEET		FEET		FEET		FEET		FEET	
40000		40000		40000		35000		30000		25000	
35000		35000		35000		30000		25000		20000	
25000		25000		25000		20000		15000		10000	
20000		20000		20000		15000		10000		5000	
15000		15000		15000		10000		5000		S.L.	
MIX-TURE		MIX-TURE		MIX-TURE		MIX-TURE		MIX-TURE		MIX-TURE	
TOT.		TOT.		TOT.		TOT.		TOT.		TOT.	
GPH.		GPH.		GPH.		GPH.		GPH.		GPH.	
MPH.		MPH.		MPH.		MPH.		MPH.		MPH.	
KTS.		KTS.		KTS.		KTS.		KTS.		KTS.	
40000		40000		40000		35000		30000		25000	
35000		35000		35000		30000		25000		20000	
25000		25000		25000		20000		15000		10000	
20000		20000		20000		15000		10000		5000	
15000		15000		15000		10000		5000		S.L.	
PRESS		PRESS		PRESS		PRESS		PRESS		PRESS	
ALT.		ALT.		ALT.		ALT.		ALT.		ALT.	
FEET		FEET		FEET		FEET		FEET		FEET	
40000		40000		40000		35000		30000		25000	
35000		35000		35000		30000		25000		20000	
25000		25000		25000		20000		15000		10000	
20000		20000		20000		15000		10000		5000	
15000		15000		15000		10000		5000		S.L.	
MIX-TURE		MIX-TURE		MIX-TURE		MIX-TURE		MIX-TURE		MIX-TURE	
TOT.		TOT.		TOT.		TOT.		TOT.		TOT.	
GPH.		GPH.		GPH.		GPH.		GPH.		GPH.	
MPH.		MPH.		MPH.		MPH.		MPH.		MPH.	
KTS.		KTS.		KTS.		KTS.		KTS.		KTS.	
40000		40000		40000		35000		30000		25000	
35000		35000		35000		30000		25000		20000	
25000		25000		25000		20000		15000		10000	
20000		20000		20000		15000		10000		5000	
15000		15000		15000		10000		5000		S.L.	

Figure 67E—Flight Operation Instruction Chart—Torpedo or Wing Bombs—
30,000 to 26,000 Lbs.—1685-HB Carburetor

LEGEND
 ALT. : PRESSURE ALTITUDE F.R. : FULL RICH
 M.P. : MANIFOLD PRESSURE A.R. : AUTO-RICH
 GPH. : U.S. GAL. PER HOUR A.L. : AUTO-LEAN
 T.A.S. : TRUE AIRSPEED C.L. : CRUISING LEAN
 KTS. : KNOTS M.L. : MANUAL LEAN
 S.L. : SEA LEVEL F.T. : FULL THROTTLE

EXAMPLE
 AT 30,000 LB. GROSS WEIGHT WITH 600 GAL. OF FUEL
 (AFTER DEDUCTING TOTAL ALLOWANCES OF 70 GAL.)
 TO FLY 800 STAT. AIRMILES AT 5000 FT. ALTITUDE
 MAINTAIN 2050 RPM AND 31 IN. MANIFOLD PRESSURE
 WITH MIXTURE SET: CRUISING LEAN

SPECIAL NOTES
 (1) MAKE ALLOWANCE FOR WARM-UP, TAKE-OFF & CLIMB (SEE FIG. 67)
 PLUS ALLOWANCE FOR WIND, RESERVE AND COMBAT AS REQUIRED.
 HIGH BLOWER ABOVE HEAVY LINE
 *WITH OR WITHOUT 8-GUN NOSE

DATA AS OF 10-1-44 BASED ON: FLIGHT TESTS

AIRCRAFT MODEL(S) B-25J*		FLIGHT OPERATION INSTRUCTION CHART								EXTERNAL LOAD ITEMS																	
ENGINE(S): R-2600-29 WITH 1685-HB CARBURETOR		CHART WEIGHT LIMITS: 29,000 TO 27,000 POUNDS								NUMBER OF ENGINES OPERATING: 1																	
LIMITS WAR 2000 EMERG. 17.5 MILITARY 2000 POWER 2500		BLOWER MIXTURE POSITION LOW F.R. LOW F.R. HIGH F.R.		TIME LIMIT 5 MIN. 5 MIN. 5 MIN.		CYL. TEMP. 200 200 200		TOTAL G.P.M. 598 482 430		NOTES: COLUMN I IS FOR EMERGENCY HIGH SPEED CRUISING ONLY. COLUMNS II, III, IV AND V GIVE PROGRESSIVE INCREASE IN RANGE AT A SACRIFICE IN SPEED. AIR MILES PER GALLON (M./GAL.) (NO WIND), GALLONS PER HOUR (G.P.H.) AND TRUE AIRSPEED (T.A.S.) ARE APPROXIMATE VALUES FOR REFERENCE. RANGE VALUES ARE FOR AN AVERAGE AIRPLANE FLYING ALONE (NO WIND). TO OBTAIN BRITISH IMPERIAL GAL. (OR G.P.H.) MULTIPLY U.S. GAL. (OR G.P.H.) BY 10 THEN DIVIDE BY 12.																	
INSTRUCTIONS FOR USING CHART: SELECT FIGURE IN FUEL COLUMN EQUAL TO OR LESS THAN AMOUNT OF FUEL TO BE USED FOR CRUISING. MOVE HORIZONTALLY TO RIGHT OR LEFT AND SELECT RANGE VALUE EQUAL TO OR GREATER THAN THE STATUTE OR NAUTICAL AIR MILES TO BE FLOWN. VERTICALLY BELOW AND OPPOSITE VALUE NEAREST DESIRED CRUISING ALTITUDE (ALT.) READ RPM, MANIFOLD PRESSURE (M.P.) AND MIXTURE SETTING REQUIRED.		COLUMN I		COLUMN II		COLUMN III		COLUMN IV		COLUMN V																	
RANGE IN AIRMILES		RANGE IN AIRMILES		RANGE IN AIRMILES		RANGE IN AIRMILES		RANGE IN AIRMILES		RANGE IN AIRMILES																	
STATUTE		STATUTE		STATUTE		STATUTE		STATUTE		STATUTE																	
960	850	1150	1000	890	790	690	1000	900	800	700	1000																
680	750	1040	890	790	690	590	890	790	690	590	900																
780	680	920	790	690	590	490	790	690	590	490	800																
680	590	800	690	590	490	390	690	590	490	390	700																
MAXIMUM CONTINUOUS M.P. INCHES MIX-TURE T.A.S. TOT. GPH. MPM. RTS.		(I.I) STAT. (.95 NAUT.) MI./GAL. () M.P. INCHES MIX-TURE T.A.S. TOT. GPH. MPM. RTS.		STAT. () MI./GAL. () M.P. INCHES MIX-TURE T.A.S. TOT. GPH. MPM. RTS.		() STAT. () MI./GAL. () M.P. INCHES MIX-TURE T.A.S. TOT. GPH. MPM. RTS.		STAT. () MI./GAL. () M.P. INCHES MIX-TURE T.A.S. TOT. GPH. MPM. RTS.		() STAT. () MI./GAL. () M.P. INCHES MIX-TURE T.A.S. TOT. GPH. MPM. RTS.		PRESS ALT. FEET 40000 35000 30000 25000 20000 15000 10000 5000 S.L.															
2400	38 F.R.	185	180	155	145	135	145	155	135	130	135	40000	40000	40000	40000	40000	40000	40000	40000	40000	40000	40000	40000	40000			
2600	38 F.R.	170	170	145	135	130	135	145	135	130	130	35000	35000	35000	35000	35000	35000	35000	35000	35000	35000	35000	35000	35000	35000		
												30000	30000	30000	30000	30000	30000	30000	30000	30000	30000	30000	30000	30000	30000	30000	
												25000	25000	25000	25000	25000	25000	25000	25000	25000	25000	25000	25000	25000	25000	25000	
												20000	20000	20000	20000	20000	20000	20000	20000	20000	20000	20000	20000	20000	20000	20000	20000
												15000	15000	15000	15000	15000	15000	15000	15000	15000	15000	15000	15000	15000	15000	15000	15000
												10000	10000	10000	10000	10000	10000	10000	10000	10000	10000	10000	10000	10000	10000	10000	10000
												5000	5000	5000	5000	5000	5000	5000	5000	5000	5000	5000	5000	5000	5000	5000	5000
												S.L.	S.L.	S.L.	S.L.	S.L.	S.L.	S.L.	S.L.	S.L.	S.L.	S.L.	S.L.	S.L.	S.L.	S.L.	S.L.

Figure 67F—Flight Operation Instruction Chart—Single Engine—29,000 to 27,000 Lbs.—1685-HB Carburetor

LIMITS		AIRCRAFT MODEL (S) B-26J*		ENGINE (S) : R-2600-29 WITH 1685-HB CARBURETOR		FLIGHT OPERATION INSTRUCTION CHART				EXTERNAL LOAD ITEMS							
WAR	EMERG.	MILITARY POWER	M.P. IN. HG.	BLOWER POSITION	MIXTURE POSITION	TIME LIMIT	CYL. TEMP.	TOTAL G.P.H.	CHART WEIGHT LIMITS: 27,000 TO 24,000 POUNDS				NUMBER OF ENGINES OPERATING: 1				
2000	2000	2000	97.5	LOW	F.R.	5 MIN.	200	598	INSTRUCTIONS FOR USING CHART: SELECT FIGURE IN FUEL COLUMN EQUAL TO OR LESS THAN AMOUNT OF FUEL TO BE USED FOR CRUISING IN MOVE HORIZONTALLY TO RIGHT OR LEFT AND SELECT RANGE VALUE EQUAL TO OR GREATER THAN THE STATUTE OR NAUTICAL AIR MILES TO BE FLOWN. VERTICALLY BELOW AND OPPOSITE VALUE NEAREST DESIRED CRUISING ALTITUDE (ALT.) READ RPM, MANIFOLD PRESSURE (M.P.) AND MIXTURE SETTING REQUIRED.				NOTES: COLUMN I IS FOR EMERGENCY HIGH SPEED CRUISING ONLY. COLUMNS II, III, IV AND V GIVE PROGRESSIVE INCREASE IN RANGE AT A SACRIFICE IN SPEED. AIR MILES PER GALLON (M./GAL.) (NO WIND), GALLONS PER HOUR (G.P.H.) AND TRUE AIRSPEED (T.A.S.) ARE APPROXIMATE VALUES FOR REFERENCE. RANGE VALUES ARE FOR AN AVERAGE AIRPLANE FLYING ALDRE (NO WIND). TO OBTAIN BRITISH IMPERIAL GAL. (OR G.P.H.) MULTIPLY U.S. GAL. (OR G.P.H.) BY 10 THEN DIVIDE BY 12.				
COLUMN I		COLUMN II		COLUMN III		COLUMN IV		COLUMN V		FUEL		RANGE IN AIRMILES		STATUTE		NAUTICAL	
RANGE IN AIRMILES		RANGE IN AIRMILES		RANGE IN AIRMILES		RANGE IN AIRMILES		RANGE IN AIRMILES		U.S. GAL.		U.S. GAL.		STATUTE		NAUTICAL	
STATUTE	NAUTICAL	STATUTE	NAUTICAL	STATUTE	NAUTICAL	STATUTE	NAUTICAL	STATUTE	NAUTICAL	STATUTE	NAUTICAL	STATUTE	NAUTICAL	STATUTE	NAUTICAL	STATUTE	NAUTICAL
700	610	820	710	790	680	560	450	340	220	110	700	600	500	400	300	200	100
600	520	710	610	680	580	470	350	230	120	600	500	400	300	200	100		
400	350	470	410	520	390	230	170	90									
300	260	350	300	390	260	120											
200	170	230	200	260	130												
100	90	120	100	130													
MAXIMUM CONTINUOUS		MAXIMUM CONTINUOUS		MAXIMUM CONTINUOUS		MAXIMUM CONTINUOUS		MAXIMUM CONTINUOUS		PRESS		MAXIMUM AIR RANGE		MAXIMUM AIR RANGE		MAXIMUM AIR RANGE	
M.P. INCHES	MIX-TURE	M.P. INCHES	MIX-TURE	M.P. INCHES	MIX-TURE	M.P. INCHES	MIX-TURE	M.P. INCHES	MIX-TURE	ALT. FEET	ALT. FEET	R.P.M.	MIX-TURE	R.P.M.	MIX-TURE	R.P.M.	MIX-TURE
2400	F.R.	2300	F.T.	2300	F.R.	2300	F.R.	2300	F.R.	40000	35000	30000	F.R.	25000	20000	15000	10000
2400	F.R.	2300	F.R.	2300	F.R.	2300	F.R.	2300	F.R.	35000	30000		F.R.	20000	15000	10000	5000
2300	F.R.	2300	F.R.	2300	F.R.	2300	F.R.	2300	F.R.	30000			F.R.	15000			S.L.

LEGEND
 ALT. : PRESSURE ALTITUDE F.R. : FULL RICH
 M.P. : MANIFOLD PRESSURE A.P. : AUTO-RICH
 G.P.H. : U.S. GAL. PER HOUR A.L. : AUTO-LEAN
 T.A.S. : TRUE AIRSPEED C.L. : CRUISING LEAN
 KTS. : KNOTS M.L. : MANUAL LEAN
 S.L. : SEA LEVEL F.T. : FULL THROTTLE

EXAMPLE
 AT 27,000 LB. GROSS WEIGHT WITH 900 GAL. OF FUEL (AFTER DEDUCTING TOTAL ALLOWANCES OF 0 GAL.) TO FLY 700 STAT. AIRMILES AT S.L. FT. ALTITUDE MAINTAIN 2200 RPM AND 33 IN. MANIFOLD PRESSURE WITH MIXTURE SET: FULL RICH

SPECIAL NOTES
 (1) MAKE ALLOWANCE FOR WARM-UP, TAKE-OFF & CLIMB (SEE FIG.) PLUS ALLOWANCE FOR WIND, RESERVE AND COMBAT AS REQUIRED.
ALL LOW BLOWER
 *WITH OR WITHOUT 8-GUN NOSE
 DATA AS OF 10-1-44 BASED ON: FLIGHT TESTS

Figure 67G—Flight Operation Instruction Chart—Single Engine—27,000 to 24,000 Lbs.—1685-HB Carburetor

ADDITIONAL COPIES OF THIS PUBLICATION MAY BE OBTAINED AS FOLLOWS:

AAF ACTIVITIES.—Submit requisitions through the Air Inspector, Technical, whenever practicable, in accordance with T. O. No. 00-25-3 to the Commanding General, Fairfield Air Service Command, Patterson Field, Ohio. Attn: Publications Distribution Branch, as outlined in AAF Regulation 5-9. For details of Technical Order distribution, see T. O. No. 00-25-3.

NAVY ACTIVITIES.—Submit requests to the Chief, Bureau of Aeronautics, Navy Department, Washington, D. C. Also, see NavAer 00-500 for details on distribution of technical publications.

BRITISH ACTIVITIES.—Submit requirements on Form 294A, in duplicate, to the Air Publications and Forms Store, New College, Leadhall Lane, Harrogate, Yorkshire, England.